

## CM900 Wireless Installation Guide

### CM927 / CM921 Wireless Programmable Room Thermostat & BDR91 Relay Box



### Description

The Honeywell CM900 Wireless (CM927 or CM921) is a modern wireless programmable room thermostat based on Honeywell's proven programming philosophy. To further improve the ease of use, this product includes an extra large LCD display with backlighting and LoT Technology to assist customers during daily use.

The CM927/921 room thermostat communicates with the BDR91 Relay Box on an 868MHz Radio Frequency (RF) band to control a single heating system component such as a boiler, pump or zone valve. Neither product will communicate with other RF products that use different frequencies or communication protocols.

*Note: The RF link between the individual room thermostat (CM927/921) and Relay Box (BDR91) in system packs provided by Honeywell is pre-configured at the factory and therefore SHOULD be installed at the same site. This makes the installation process fast and easy, but if products from individual system packs are separated, or mixed with other pre-configured system packs during installations please refer to section 5.1 **Binding / Rebinding Procedure** to bind the desired units together and allow them to communicate with each other.*

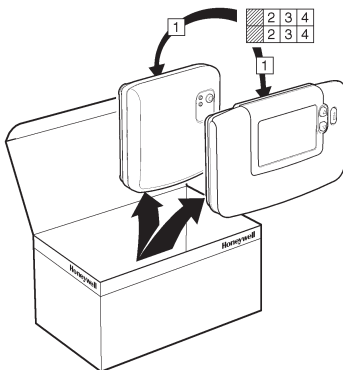

### Table of Contents

Section	Page
<b>1) Installation Information .....</b>	<b>2</b>
<b>2) Installing the CM900 Wireless System .....</b>	<b>3</b>
2.1 Installing the Relay Box .....	3
2.2 Installing the Room Thermostat .....	4
2.2.1 Power Up .....	4
2.2.2 RF Communication Check .....	4
2.2.3 Locating the Room Thermostat .....	5
2.3 System Check .....	5
<b>3) Basic Operation of the System .....</b>	<b>6</b>
3.1 Automatic Operation .....	6
3.2 Temporary Manual Override .....	6
3.3 Communication Loss .....	6
<b>4) Installer Mode .....</b>	<b>6</b>
4.1 Entering Installer Mode .....	7
4.2 BDR91 Relay Box Fail-Safe Mode Setup .....	7
4.3 Using the Room Thermostat for Specific Applications ..	8
4.4 Using the Special Features of the Room Thermostat ..	8
4.5 Installer Parameters Table .....	9
4.5.1 Category 1 - Room Thermostat Settings .....	9
4.5.2 Category 2 - System Settings .....	10
<b>5) Additional Installation Information .....</b>	<b>11</b>
5.1 Binding / Rebinding Procedure .....	11
5.2 Multi-Zone System .....	11
5.3 Binding an HR80 Radiator Controller to the Room Thermostat .....	11
<b>6) Trouble Shooting .....</b>	<b>12</b>
6.1 Trouble Shooting Guide .....	12
6.2 Diagnostics Mode .....	12

# 1) Installation Information

As these products communicate using RF technology special care must be taken during installation. The location of the RF components as well as the building structure may influence performance of the RF system. To assure system reliability, please review and apply the information given below.

Within a typical residential building the two products should communicate reliably within a 30m range. It is important to take into consideration that walls and ceilings will reduce the RF signal. The strength of the RF signal reaching the Relay Box depends on the number of walls and ceilings separating it from the room thermostat, as well as the building construction - the diagram below illustrates an example of typical signal strength reduction. Walls and ceilings reinforced with steel or plasterboard walls lined with metal foil reduce the RF signal significantly more.

Once a position is selected for the room thermostat this can be checked using the RF Communication Test mode as described in section **2.2.3 Locating the Room Thermostat**. If the position is unsuitable the Relay Box will not respond and an alternative position must be selected.

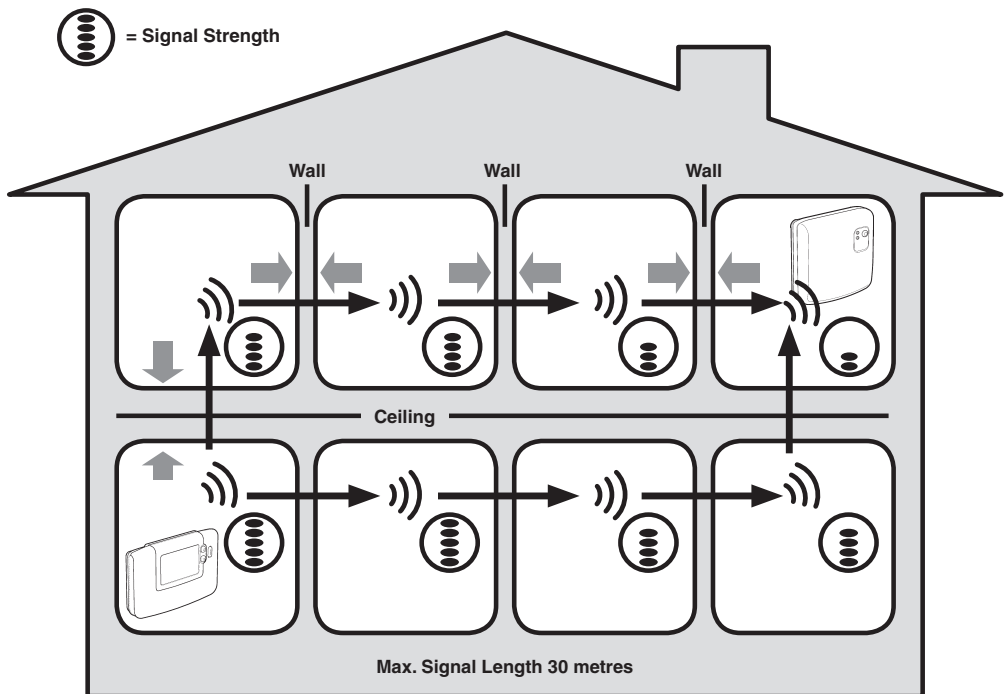

Typical example of Building Fabric Signal losses

## 2) Installing the CM900 Wireless System

Please follow the illustrations and information below in sequence to install the Relay Box and room thermostat correctly. For applications other than gas boilers, enabling special features and to see what other system options are available refer to section **4) Installer Mode**.

### 2.1 Installing the Relay Box

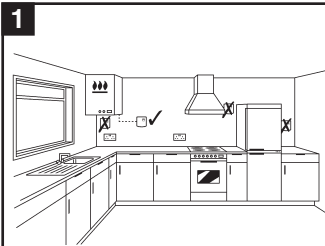

The Relay Box is a RF device. For the best performance install in an open space. Leave at least 30cm distance from any metal objects including wall boxes and boiler housing.

**Do not mount on metal wall boxes.**

#### EMC compliance considerations

Keep AC mains supply/load cables separate from signal wiring.

Refer to Code of Practice standards EN61000-5-1 and -2 for guidance.

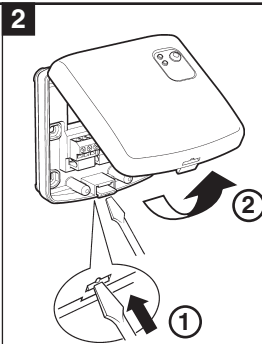

**NOTE:** The Relay Box contains no user serviceable parts. It should be opened and installed by qualified installer only.

**WARNING:** Electrostatic sensitive device! Do not touch the circuit board.

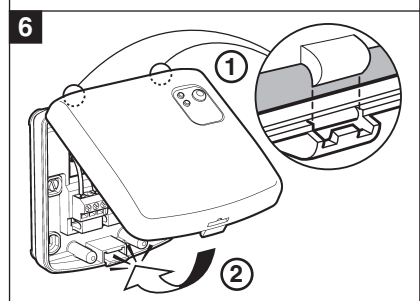
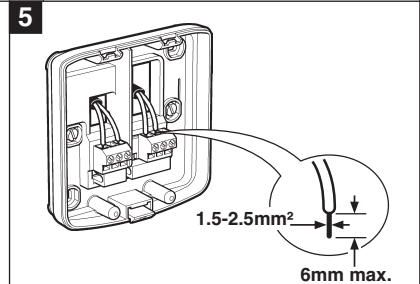
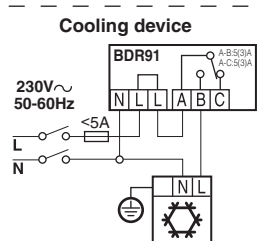
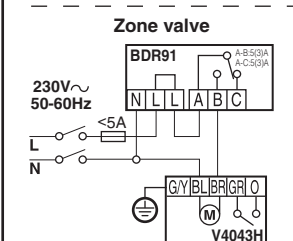
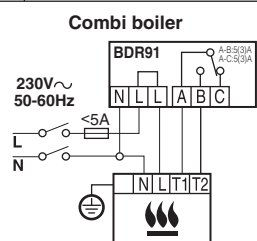
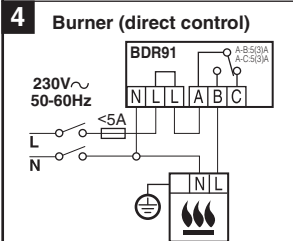
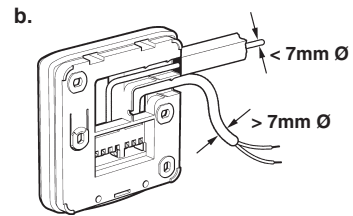
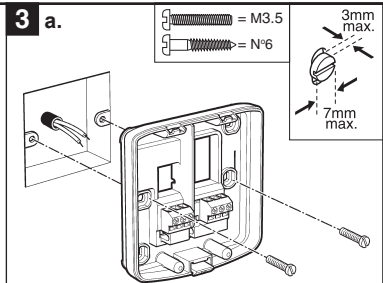











**NOTE:** All wiring must be in accordance with IEE regulations

**CAUTION:** Observe ambient temperature and current limits (see the Relay Box wiring label)



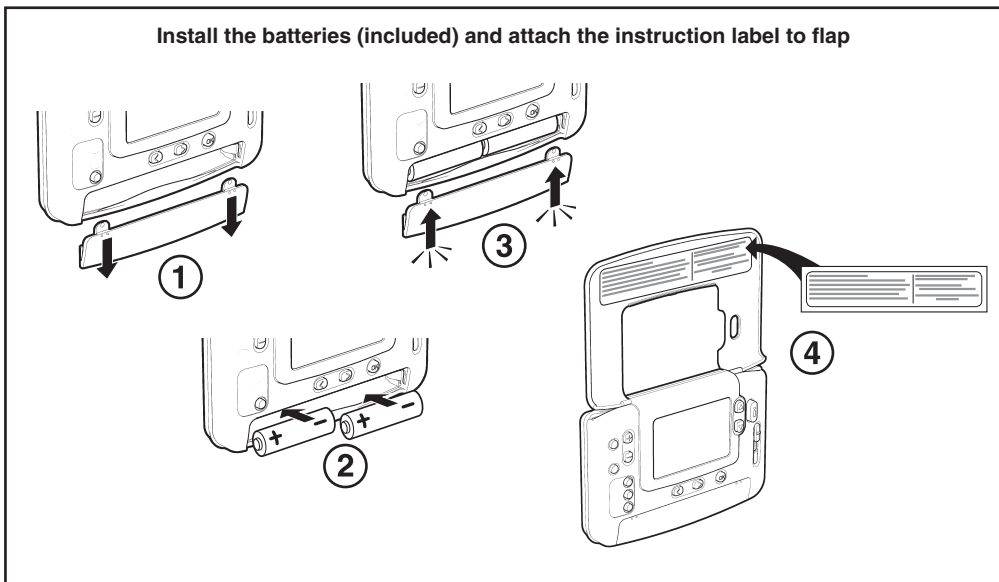

## 2.2 Installing the Room Thermostat

### 2.2.1 Power Up

1. Remove the battery cover and insert the batteries supplied with the room thermostat (2 x AA LR6 Alkaline Batteries).
2. On the initial power up the available user interface languages will be displayed (only on certain models). Use the   or  buttons to cycle through the options until the desired language is displayed. Press the green  button to confirm the selection.
3. Set the slider switch to the **DATE** mode.
4. Use the  or  buttons to set the correct day / month / year, pressing the green  button to confirm.
5. Use the  or  buttons to set the correct time, pressing the green  button to confirm.



### 2.2.2 RF Communication Check (Test Mode)

To check the RF communication, hold the room thermostat about 2-3 metres from the installed Relay Box. Move the slider on the room thermostat to the **OFF** position then press the   and  buttons together with the  button for 3 seconds. The unit will display 'TEST TRANSMIT' and it will send test signals to the Relay Box, flashing the green LED on every 6 seconds (relay output will remain off) for a maximum of 10 minutes. When the green LED flashes on every 6 seconds proceed to the next step.

**NOTE:** If the green LED is not switched at specified intervals, the red LED is flashing or if you are installing a replacement Relay Box or room thermostat, follow the procedures described in section **5.1 Binding / Rebinding Procedure**.

## 2.2.3 Locating the Room Thermostat

While still in the Test Mode, as described in section 2.2.2, the room thermostat should be located taking the following into consideration and reviewing the illustrations below:

1. Find a suitable location where the signal transmission is reliable. Reliable transmission is indicated when the Relay Box is flashing the green LED every 6 seconds. **NOTE:** *The Relay Box relay will be off.*
2. Install the room thermostat EITHER on the wall using the wall bracket OR attach the optional table stand as shown in below.
3. Exit the Test Mode by moving the setting slider to the required operating mode (**AUTO** or **OFF**).

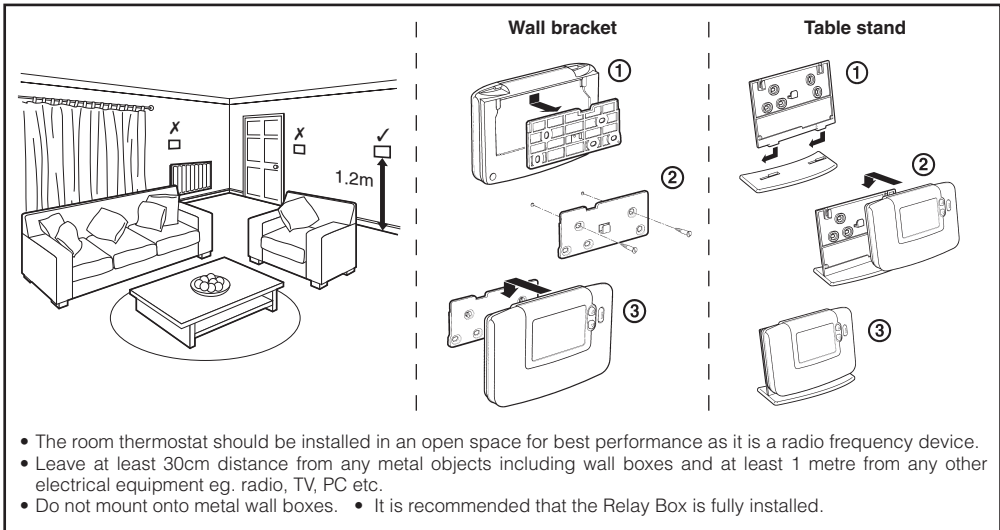

## 2.3 System Check

Now a simple test can be completed to check the full system has been installed correctly:

1. Set the slider switch to the **OFF** mode.
2. Check the boiler supply is on and check that the green LED on the Relay Box is off.
3. Set the slider switch to the **MAN** mode.
4. Adjust the setpoint up to the maximum (35°C) by pressing the button. The boiler should come on (green LED **ON** on Relay Box) after a few seconds and the symbol appears on the room thermostat LCD display.
5. Set the slider switch to the **OFF** mode. The boiler will go off (green LED **OFF** on Relay Box) after a few seconds and the symbol disappears.
6. Check the system operation by moving the slider between **MAN** and **OFF** modes several times, bearing in mind the switching delay referred to above.

Now, you should have completed the installation successfully - to begin operating at the default factory settings move the slider to the **AUTO** mode or select **PROG** to modify the built-in heating program accordingly.

## 3) Basic Operation of the System

### 3.1 Automatic Operation

The Relay Box receives the heat demand (0-100%) signal from the room thermostat. The room thermostat will display the 🔥 symbol on the LCD display whenever more heat is required. Depending on the demand the Relay Box will switch the heating device on to match the current requirements of the system.

The green LED indicates the status of the relay output:

- Green LED on = relay on
- Green LED off = relay off

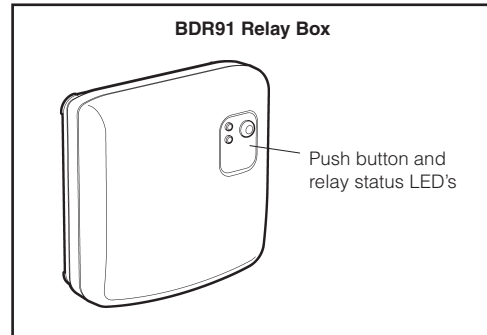

### 3.2 Temporary Manual Override

Pressing the Relay Box button will override the current relay position. As soon as the next signal is received from the room thermostat the Relay Box will return back to automatic operation as the automatic control has higher priority than manual operation.

### 3.3 Communications Loss

If the RF communication is lost for a period of 1 hour the red LED will illuminate to indicate that no RF messages have been received during the last hour.

The Relay Box will also enter the failsafe mode as selected in **Installer Mode** (see section **4.2 BDR91 Relay Box Fail-Safe Mode Setup**). To allow manual control of the Relay Box output manual override is available in fail-safe mode. When RF communication is restored the Relay Box will automatically return to normal operation.

You can now use the **USER GUIDE** supplied with the room thermostat to demonstrate how it works to the home owner.





## 4) Installer Mode

Installer Mode is used to alter the system settings for specific applications, to use the special features of the room thermostat in a different way or to alter the factory preset parameters. Parameters are divided into two groups:

- Category 1 parameters – Room Thermostat Setup
- Category 2 parameters – System Setup.

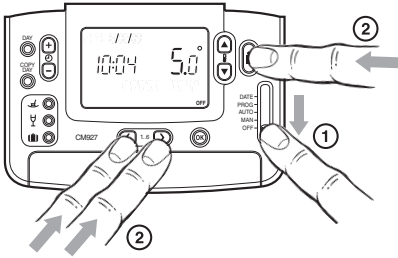
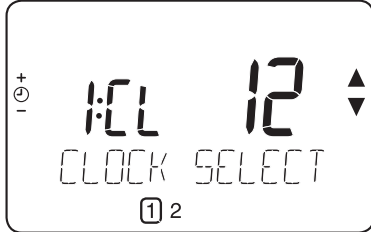
These are all listed in section **4.5 Installer Parameters Table**.

## 4.1 Entering Installer Mode

<p><b>1</b></p>  <p>Move the slider switch to the <b>OFF</b> mode.</p> <p>Press and hold the <b>OK</b> button and the two <b>←</b> &amp; <b>→</b> buttons together.</p>	<p><b>2</b></p>  <p>The unit will display the first parameter of installer parameter group <b>category 1</b> (from Parameter n.1 to n.19) as shown</p>
<p><b>3</b></p> <p>Press the <b>▲</b> or <b>▼</b> to change factory setting.</p> <p>The display will flash indicating that a change has been made.</p> 	<p><b>4</b></p> <p>Press the green <b>OK</b> button to confirm the change.</p> <p>The display will stop flashing.</p> 
<p><b>5</b></p> <p>Press <b>⊕</b> button to go to the next parameter.</p> 	<p><b>6</b></p> <p>Press <b>▶</b> button to go to Installer parameter group <b>category 2</b> (2) (from Parameter n.1 to n.14).</p>
<p><b>7</b></p> <p>To exit the installer mode, move the slider switch to the <b>AUTO</b> or <b>MAN</b> positions.</p>	

## 4.2 BDR91 Relay Box Fail-Safe Mode Setup





The failsafe mode defines the Relay Box output relay status if the RF communication is lost (e.g. when the room thermostat stops communicating due to discharged batteries). The factory setting keeps the relay permanently off when communications is lost. If this factory setting needs to be changed follow the instructions below:

1. Enter Installer mode as described above.
2. Press the **▶** button to enter category 2 parameters.
3. Select the parameter 7:LC by pressing the **⊕** button.
4. Select the fail-safe mode by pressing **▲** or **▼** buttons:
  - 0 - when RF communication is lost the relay will be held in **OFF** position.
  - 1 - when RF communication is lost the relay output will cycle at 20% on 80% off.
5. Press the green **OK** button to accept the change.
6. Attach appropriate label to the Relay Box to indicate the selected fail-safe mode.

**IMPORTANT:** To enable the frost protection when RF communication is lost, select the fail-safe mode 1. For systems with separate frost protection thermostat or where frost protection is not required select fail-safe mode 0.

### 4.3 Using the Room Thermostat for Specific Applications

The CM927/921 RF room thermostat is a versatile controller that can be used to control many different applications. For most typical applications, like wall-hung gas fired combination boiler control or zone valve control, no adjustments from the factory settings are required. For other applications, like controlling an oil burner, the best system performance can be achieved by modifying selected parameters of the room thermostat in the Installer mode. The table below lists the most common settings used for specific applications.

Specific Application:		Setting:		What to change:
		Cycle/ Hour	Minimum ON Time	<b>Note:</b> All parameters listed below belong to <b>category 2</b> - System Parameters (see <b>Installer Parameters Table</b> )
<b>HEATING</b>	Gas Boiler (<30kW)	6	1	No changes required
	Oil Boiler	3	4	Set 1:Ot parameter to 4 Set 2:Cr parameter to 3
	Thermal Actuator	12	1	Set 2:Cr parameter to 12
	Zone Valve	6	1	No changes required
<b>AIR-CONDITIONING</b>				To enable switching between cooling and heating modes adjust parameter 4:HC in category 2 (0 = disabled, 1 = enabled). Now you can switch between these modes by pressing the  and  buttons together for 5 seconds in any of the product operating modes ( <b>AUTO</b> , <b>MAN</b> or <b>OFF</b> ). Explain to the end user how to switch between these modes using the  and  buttons and ensure the cooling program is modified as required.
	Heat Pump / Air-Conditioner	3	4	Set 1:Ot parameter to 4 Set 2:Cr parameter to 3
	Fan Coil	6	1	No changes required

### 4.4 Using the Special Features of the Room Thermostat

Special Feature:	Description:	Enable/Disable
Optimisation (Variable Start Time)	The thermostat will adjust the start time in the morning/afternoon so the desired temperature is reached by the start of the program period. The system will restrict the start time to a max of 2 hours.	To enable: Set parameter 8: OP (category 1) to 1.
Heating or Cooling Operation	This product can be used for heating or cooling applications. If you select cooling mode the control algorithm and factory default program will be modified. You can independently modify the heating and cooling profile.	To enable: Set parameter 4: HC (category 2) to 1.
Summer/Winter Auto time change	This feature moves time automatically on the last Sunday of March and the last Sunday of October. The feature is factory enabled.	To enable: Set parameter 3: tC (category 1) to 1.
Temperature Offset	If the thermostat is located in a particularly hot/cold location for reliable signal transmission reasons then the measured/displayed temperature can be adjusted by +/- 3°C. This is useful if the homeowner wants the reading to match another appliance temperature display.	Set parameter 12:tO (category 1) to the required offset value.
Upper/Lower Temperature Limit	The normal upper temperature limit of 35°C can be reduced to 21°C to save the homeowner energy. The normal lower limit of 5°C can be increased up to 21°C to protect inhabitants from cold.	Set parameter 6:uL (category 1) to the desired upper limit.  Set parameter 7:lL (category 1) to the desired lower limit.



## 4.5 Installer Parameters Table

### 4.5.1 Category 1 - Room Thermostat Settings

Parameter	Parameter No.	Factory Default Setting		Optional Setting	
<i>Category 1 Parameters – Room Thermostat Settings</i>					
		Display	Description	Display	Description
AM-PM / 24hr Display	1:CL	24	24 hr clock display format	12	12 hr – AM/PM clock display format
Reset Time/ Temp Program	2:rP	1	Time / Temp profile set to factory default  Changes to 0 when one of the time/temp profiles are changed	0	Time / Temperature are as programmed  To restore the factory profile set to 1
Auto Summer/ Winter Time Change	3:tC	1	Auto Summer/Winter Time Change Enabled	0	Auto Summer/Winter Time Change Disabled
LCD Backlighting	5:bL	1	Backlighting Enable	0	Backlighting Disabled
Upper Temp Limit	6:uL	35	35°C Upper Temp. Limit	21 to 34	21°C to 34°C adjustment in 1°C steps
Lower Temp Limit	7:LL	5	5°C Lower Temp. Limit	5 to 21	6°C to 21°C adjustment in 1°C steps
Optimisation	8:OP	0	Optimisation Disabled	1	Optimisation Enabled
Temperature Offset	12:tO	0	No temperature offset	-3 to +3	-3°C to +3°C adjustment in 0.1°C steps
Proportional Band Width	13:Pb	1.5	Proportional band of 1.5 degrees	1.6 to 3.0	1.6°C to 3.0°C adjustment in 0.1°C steps
Reset Parameters to Factory Defaults	19:FS	1	All settings at factory defaults  Changes to 0 when one of the parameter is changed	0	Settings are as modified above  To restore the factory profile set to 1

#### Notes

- 1) Remember to always press the green  button to confirm that you want to store your new Installer Set-Up setting. To exit the Installer Mode move the slider switch to the **AUTO** or **MAN** position.

## 4.5.2 Category 2 - System Settings

Parameter	Parameter No.	Factory Default Setting		Optional Setting	
<i>Category 2 Parameters – System Settings (press the  button to access this category)</i>					
		Display	Description	Display	Description
Minimum boiler ON time	1:Ot	1	1 minute minimum ON time	2 to 5	Selection of 2, 3, 4 or 5 minutes minimum ON time
Cycle Rate	2:Cr	6	6 cycles per hour (cph)	3,9 or 12	Selection of 3, 9 or 12 cph
Heat/Cool Change	4:HC	0	Disabled	1	Enabled
Pump Exercise	5:PE	0	Pump exercise disabled	1	Pump exercise enabled
System Synchronisation	6:Sn	0	Standard operation of the Room Unit	1	Room unit configured as Synchroniser
Loss of Communications Instruction	7:LC	0	Relay Off	1	Relay 20% on / 80% off
<i>The following Parameters are for the control of other Honeywell Wireless products such as Wireless Underfloor Heating controls and Wireless Radiator controls. For more information please contact Honeywell sales.</i>					
Room Temperature Sensor Use	8:Su	0	BDR91 control	1,2,3 or 4	1 - HR80/HM80 control with own/remote sensor (no temperature displayed) 2 - HR80/HM80/HCE80 control with CM sensor 3 - BDR91 control and HR80/HM80/HCE80 control with own/remote sensor 4 - Hr80/HM80/HCE80 control with own/remote sensor (temperature displayed)
HR80 Window-Open Function	9:HO	0	Disabled	1	Enabled
HR80 Local Override	10:HL	1	Enabled	0	Disabled
Maximum Flow Setpoint	11:uF	55	55°C Maximum Flow Temp.	0 to 99	0°C to 99°C adjustment in 1°C steps
Minimum Flow Setpoint	12:LF	15	15°C Minimum Flow Temp.	0 to 50	0°C to 50°C adjustment in 1°C steps
Mixing Value Run Time	13:Ar	150	150 seconds	0 to 240	0 to 240 sec. adjustment in 1sec steps
Pump Overrun Run Time	14:Pr	15	15 minutes	0 to 99	0 to 99 mins adjustment in 1min steps

### Notes

- 1) Remember to always press the green  button to confirm that you want to store your new Installer Set-Up setting. To exit the Installer Mode move the slider switch to the **AUTO** or **MAN** position.
- 2) These parameters are set centrally for the zoning system at the room thermostat configured as the system synchroniser.
- 3) Minimum on-time setting applies only to the boiler controller. All Relay Box zone controllers will work with the minimum on-time of 30 seconds.

## 5) Additional Installation Information

### 5.1 Binding / Rebinding Procedure

The binding operation described below is required if:

- Any of the system components (room thermostat or Relay Box) are replaced.
- The Relay Box has incorrect or no binding data stored (e.g. when pre-bound system pack components have been mismatched).

**NOTE:** During the binding procedure keep approximately 1m distance between the room thermostat and the Relay Box.

#### To bind/rebind:

1. Press and hold the Relay Box push button for 15 seconds to reset any previously stored data. After 15 seconds the red LED will change to flashing 0.1sec on/0.9sec off.

**NOTE:** After 5 seconds the red LED will start to flash 0.5sec on/0.5sec off, but continue to hold the button).

2. Release the push button.
3. Press and hold the Relay Box push button for 5 seconds to enter the binding mode. The Red LED will start flashing at 0.5sec on/0.5sec off to confirm the binding mode has been entered.
4. Move the room thermostat slider to the **OFF** position and press the **f** **▲** and **▼** buttons together along with the **☰** button. The unit will display InSt and 'CONTROL BINDING'.
5. Press the green **OK** button to send the binding signal out to the Relay Box. The red LED is switched off to confirm successful binding operation. If the red LED still flashes push the button again until binding is successful.
6. Now go to Section **2) Installing the CM900 Wireless System** to setup the system.

### 5.2 Multi-Zone System

Multiple room thermostats and Relay Box sets can also be used to control multi-zone systems and the CM927/921 room thermostat is compatible with a variety of other Honeywell products including HR80 radiator controllers (see below) and HCE80 underfloor heating controllers. If you intend to use it in this way additional installation and user instructions can be obtained by contacting the address at the end of this guide.

**NOTE:** Some of the labels supplied with the pack are for use in multi-zone applications.

### 5.3 Binding an HR80 Radiator Controller to the Room Thermostat

1. Press the bind button (1) for approximately one second and release. When the button is released, the **☰** symbol flashes and the software version number is displayed for 30 seconds.
2. Move the room thermostat slider to the **OFF** position and press the **f** **▲** and **▼** buttons together along with the **☰** button. The unit will display InSt and 'CONTROL BINDING'.
3. Press the green button to send the binding signal out to the radiator controller.
4. The radiator controller will display **59°C** once the signal has been received.

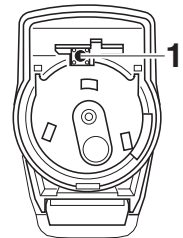





#### If several radiator controllers are to be controlled simultaneously in one room:

1. Press the bind button on all the radiator controllers to be bound to the room thermostat. The **☰** symbol flashes continuously on the display of the radiator controller.
2. Move the room thermostat slider to the **OFF** position and press the **f** **▲** and **▼** buttons together along with the **☰** button. The unit will display InSt and 'CONTROL BINDING'.
3. Press the green **OK** button to send the binding signal out to the radiator controllers.
4. The radiator controllers will display **59°C** once the signal has been received. The set temperature at the radiator controller is automatically set to 20°C.





**NOTE:** The radiator controller can take up to 4 minutes to receive data from the room thermostat.

## 6) Trouble Shooting

### 6.1 Trouble Shooting Guide

Symptom (Fault Message)	Possible Cause	Remedy
The room thermostat displays the  symbol but the Relay Box relay does not switch on.	This is normal operation. The Relay Box cycles the relay on and off for times proportional to the demand signal (0-100%) from the room thermostat. The  symbol only indicates that the demand value is greater than 0%.	Using the   button change the temperature setpoint by a few degrees. The Relay Box should switch the relay on after a few seconds delay.
The Relay Box does not react to setpoint changes on the room thermostat.	The room thermostat and Relay Box are not bound.	Reset the Relay Box by pressing and holding the push button for 15 seconds. Then follow the binding / rebinding procedure as described in section <b>5) Additional Installation Information</b> .
After the binding procedure the red LED is on and the green one is flashing once every 3 sec on the Relay Box.	Incorrect or incomplete binding procedure. Incorrect position of the room thermostat during binding.	Repeat the binding procedure. Repeat the binding procedure keeping approx. 1 m distance between the Relay Box and the room thermostat.
The red LED on the Relay Box is illuminated (Communication loss)	The Relay Box receives no RF messages from the room thermostat:  RF signal is blocked due to wrong location of the room thermostat.  Room thermostat batteries are exhausted.	Re-locate the room thermostat following instructions in section <b>2) Installing the CM900 Wireless System</b> .  Replace batteries in the room thermostat.

### 6.2 Diagnostic Mode

The CM927/921 room thermostat has a user accessible mode that provides information useful to a remote service person and a means of checking whether the boiler is working. To access this move the slider switch to the **OFF** position then press and hold the  button for 5 seconds. The room thermostat will enter the user settings mode. Next press and hold the  and  buttons together. The room thermostat will hold the relay on for 5 minutes and the following information can be viewed on the display by pressing the   buttons. : model ID, date code (WW/YY) & checksum.

Hereby, Honeywell declares that this CM927/CM921 room thermostat and BDR91 Relay Box are in compliance with the essential requirements and other relevant provisions of Directive 1999/5/EC, 2006/95/EC and 2004/108/EC.

Manufactured for and on behalf of the Environmental and Combustion Controls Division of Honeywell Technologies Sàrl, ACS-ECC EMEA, Z.A. La Pièce 16, 1180 Rolle, Switzerland by its Authorised Representative Honeywell International Inc.

#### Honeywell Control Systems Ltd.

Arlington Business Park,  
Bracknell, Berkshire  
RG12 1EB

Technical Help Desk: 08457 678999  
www.honeywelluk.com



50039987-003 A  
© 2009 Honeywell International Inc.

# Honeywell