

T6360/T4360

Installation Instructions

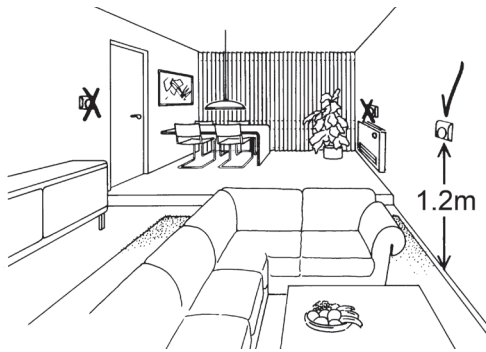

Positioning of thermostat



1 Cover removal

Caution: Isolate power supply and make safe before wiring the unit to prevent electric shock and equipment damage. Installation should be carried out by a competent person.

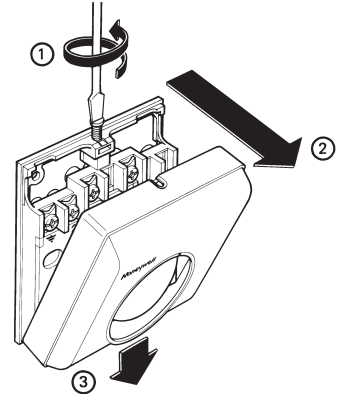

4200637-001 R8

2 a

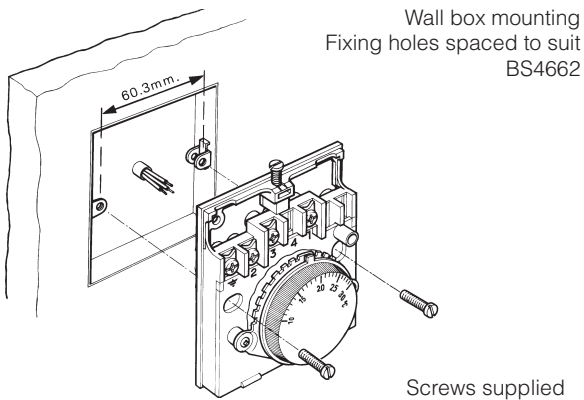

b

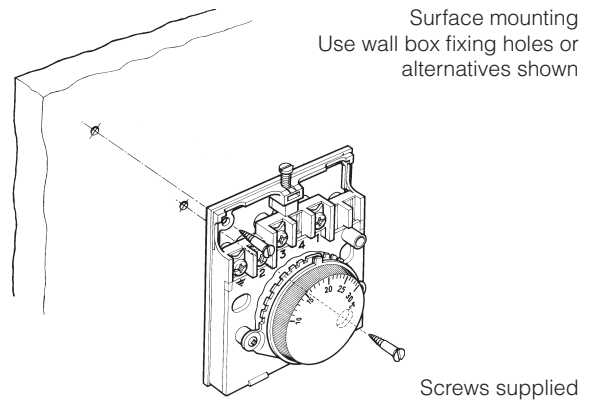

3 a Wall box wiring

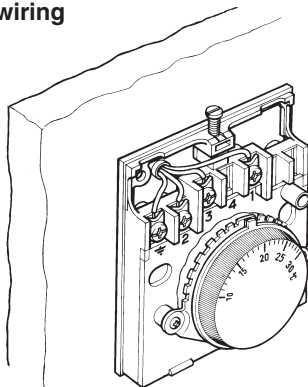

b Surface wiring

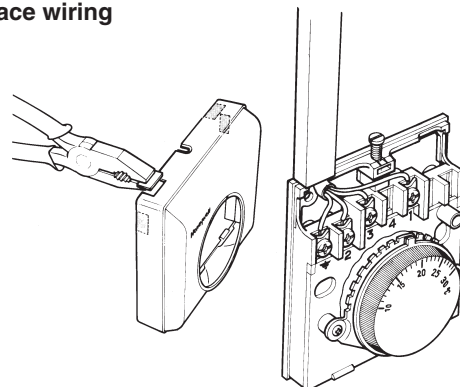

4 a Wiring to terminals

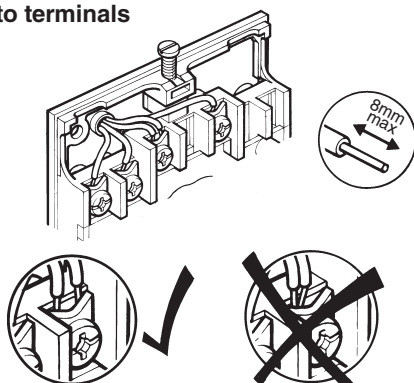

5 Completion

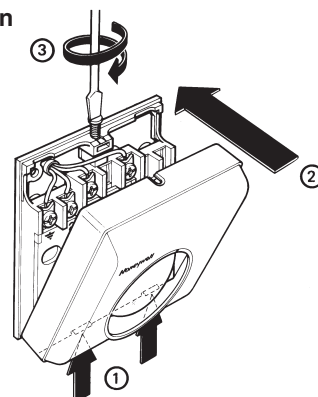

All wiring must be in accordance with IEE Regulations. This thermostat is for fixed wiring only.

A switch, having contact separation of at least 3mm in all poles, must be incorporated in the fixed wiring as a means of disconnecting the supply.

The thermostat is a Class II (double insulated) device. A parking terminal is provided for external earth wiring continuity.

The heating system must be appropriately fused. Most typical wet heating systems should be fused at 3 Amps. Warm air and electrical systems may have a higher load. Maximum fuse ratings are 10 Amps for T6360B and T4360E, or 16 Amps for T4360B.

The thermostat has 4 knockouts on the cover for surface wiring installations. Care must be taken to use the knockouts so that the cable completely fills the knockout hole without leaving any gaps. Where used, mini-trunking must be fitted firmly against the thermostat cover in such a way as to leave no gap.

For T6360B and T4360E a neutral connection must be made to terminal 2 when the heating load is less than 6 Amps.

Replacement

For Central Heating applications up to 6 Amps, use T6360B.

For application between 6 Amps and 10 Amps, again use a T6360B, but without the neutral connection (see above note regarding neutral connection).

Use T4360B in high current applications up to 16 Amps.

EMC compliance considerations

Keep AC mains supply/load cables separate from signal wiring. Refer to Code of Practice EN61000-5-1 and -2 for guidance.

Wiring diagrams

Standard thermostat with anticipator

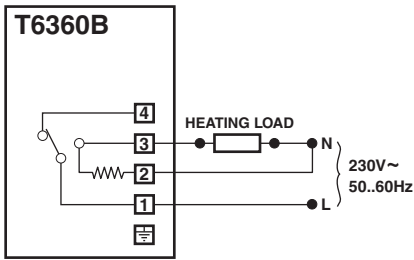

Terminal 3: 10(3) A max
 Terminal 4: 6(2) A max
 Indicator Lamp Version:
 - Lamp internally wired
 - illuminated on call for heat
 Terminal 4 output typically only used eg to drive closed a drive open / drive closed valve actuator

High current thermostat

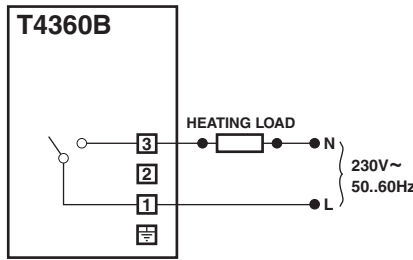

Terminal 3: 16 A max
 Electric heat loads only
 No anticipator connection required

Setback thermostat with anticipator

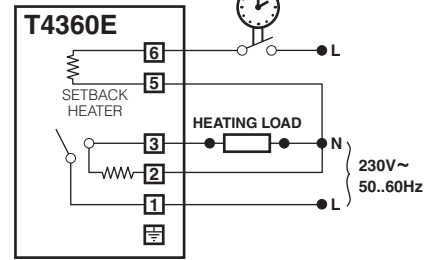

Terminal 3: 10(3) A max
 Setback feature requires external timed input to operate (e.g. from a heating timer such as ST9100)

What is a room thermostat? ...an explanation for householders

A room thermostat simply switches the heating system on and off as necessary. It works by sensing the air temperature, switching on the heating when the air temperature falls below the thermostat setting, and switching it off once this set temperature has been reached.

Turning a room thermostat to a higher setting will not make the room heat up any faster. How quickly the room heats up depends on the design of the heating system, for example, the size of boiler and radiators.

Neither does the setting affect how quickly the room cools down. Turning a room thermostat to a lower setting will result in the room being controlled at a lower temperature, and saves energy.

The heating system will not work if a time switch or programmer has switched it off.

The way to set and use your room thermostat is to find the lowest temperature setting that you are comfortable with, and then leave it alone to do its job. The best way to do this is to set the room thermostat to a low temperature – say 18°C – and then turn it up by one degree

each day until you are comfortable with the temperature. You won't have to adjust the thermostat further. Any adjustment above this setting will waste energy and cost you more money.

If your heating system is a boiler with radiators, there will usually be only one room thermostat to control the whole house. But you can have different temperatures in individual rooms by installing thermostatic radiator valves (TRVs) on individual radiators. If you don't have TRVs, you should choose a temperature that is reasonable for the whole house. If you do have TRVs, you can choose a slightly higher setting to make sure that even the coldest room is comfortable, then prevent any overheating in other rooms by adjusting the TRVs.

Room thermostats need a free flow of air to sense the temperature, so they must not be covered by curtains or blocked by furniture. Nearby electric fires, televisions, wall or table lamps may prevent the thermostat from working properly.



IMPORTANT: No user serviceable parts. Do not dispose of in a fire.

This product and its associated documentation and packaging are protected by various intellectual property rights belonging to Honeywell Inc and its subsidiaries and existing under the laws of the UK and other countries. These intellectual and property rights may include patent applications, registered designs, unregistered designs, registered trade marks, unregistered trade marks and copyrights. Honeywell reserves the right to modify this document, product and functionality without notice. This document replaces any previously issued instructions and is only applicable to the product(s) described. This product has been designed for applications as described within this document. For use outside of the scope as described herein, refer to Honeywell for guidance. Honeywell cannot be held responsible for misapplication or the product(s) described within this document. Manufactured for and on behalf of the Environmental and Combustion Controls Division of Honeywell Technologies Sàrl, ACS-ECC EMEA, Z.A. La Pièce 16, 1180 Rolle, Switzerland, by its Authorised Representative Honeywell Inc.

Honeywell Control Systems Ltd.

Arlington Business Park,
 Bracknell
 Berkshire, RG12 1EB
 Technical Help Desk: 08457 678999
 www.honeywelluk.com

