

# evohome Installation Guide



---

## Icon key

---



**evohome** Controller



**evohome** Controller Wall Bracket (ATF300)



**evohome** Controller Table Stand (ATF100 or ATF200)



Radiator Controller (HR92)



Radiator Controller (HR80)



Wireless Relay Box (BDR91)



Remote Access Gateway (RFG100)



Underfloor Heating Controller (HCE80 or HCC80)



Wireless OpenTherm Bridge (R8810)



Mixing Valve Controller (HM80)



Room Temperature Sensor (HCW82)



Room Temperature Sensor (HCF82)



Digital Room Thermostat (DTS92)



Wireless Cylinder Thermostat Transceiver (CS92)



Wireless Cylinder Thermostat Strap-on Sensor (CS92)



Wireless Cylinder Thermostat Insertion Sensor (CS92)

---

## Thanks for choosing **evohome**

**evohome** means more comfort, and more control of the heating system. It's simple to install and easy to use.

Follow these instructions to set up the **evohome** system. Devices that need to be connected to the mains electricity supply should be installed by a competent person.

## Before you start

Make sure you have all the devices you need for your system. If you used our 'Design your **evohome** system' guide, match each device to the room or zones in your plan. It's a good idea to carry out all the mains electrical and other wiring work first.

---

## In this guide

Step 1: Wire up the heating system	3
Step 2: Set up your <b>evohome</b> Controller	9
Step 3: Power up and bind devices	13
Step 4: System test	29
Configuration and modification	37
Appendix	41

---

**You have...**

a Base Pack or a Connected Pack  
+  
Un-bound devices

**You have...**

an un-bound evohome Controller  
+  
Un-bound devices

**You have...**

a Base Pack or a Connected Pack  
+  
No additional devices



**Step 1: Wire up your heating system**

Connect all mains powered devices to the heating system



**Step 2: Set up your evohome Controller**

Power up the evohome Controller and follow the on-screen instructions for your system

Go to Installer Menu



Go to Guided Configuration



Go to Home screen



**Step 3: Power up and bind devices**

Power up all devices, including the battery powered ones,  
and bind them to the evohome Controller



**Step 4: Test the system**

Check that all the devices are working properly

---

# Step 1: Wire up the heating system

**evohome** communicates using wireless on a robust 868Mhz signal that is unaffected by common remote controls or Wifi.

Some devices need mains power or to be connected to external equipment and it's best to wire up these items first to simplify the binding process later in the setup. The evohome controller will give on screen instructions when these should be powered up.

Before you power up your **evohome** Controller and install the radiator controllers, it's best to install any devices which are mains powered or need specific installation.

---

## In this section

Wireless Relay Box (BDR91)	4
Wireless Cylinder Thermostat (CS92)	5
Remote Access Gateway (RFG100)	7
Mixing Valve Controller (HM80), Underfloor Heating Controller (HCE80/HCC80), Opentherm Bridge (R8810)	8

---

## Wireless Relay Box (BDR91)

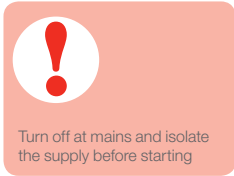

### If you're fitting a Wireless Relay Box (BDR91) to your boiler, zone valve or Sundial valve

- 1 Mount the Wireless Relay Box on a non-metal surface at least 30cm from your boiler, other wireless device or metal objects
- 2 Release the clip on the bottom to open the front cover
- 3 Follow the wiring diagram (see Appendix: Figures 5-10) to connect the Wireless Relay Box to your boiler's thermostat terminals, zone valve or sundial valve, and to the mains electricity supply
- 4 Replace the cover

Refer to boiler instruction to locate the room thermostat terminals, determine if the boiler required a permanent live supply.

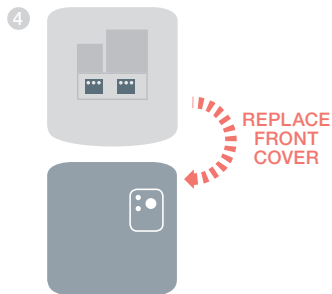
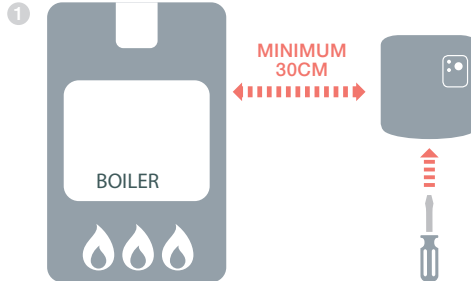

# Wireless Cylinder Thermostat (CS92)



## If you're fitting a Wireless Cylinder Thermostat (CS92)

You will need to install the CS92 Transceiver and only one of the two sensors (CS92 Strap-on Sensor or CS92 Insertion Sensor).



## To fit the CS92 Strap-on Sensor

- 1 Cut away a section of cylinder insulation slightly larger than the sensor unit
- 2 Clean the exposed cylinder surface
- 3 Place the sensor on the cylinder surface and secure it using the fixing strap – cut the strap to size if it's too long
- 4 Install the CS92 Transceiver in a suitable location close enough for the cable from the sensor to reach
- 5 Connect the cable from the sensor to the CS92 Transceiver

Position the sensor from one quarter to a third of the way up the cylinder.

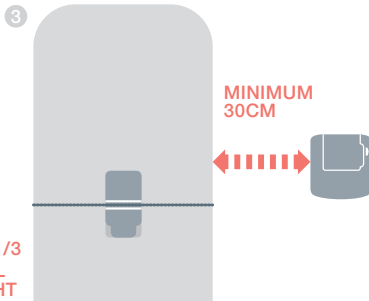
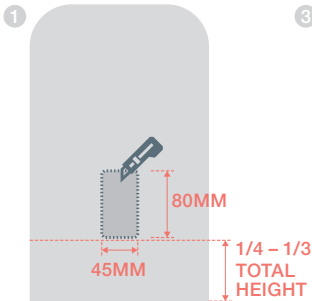

Wire to CS92 Transceiver

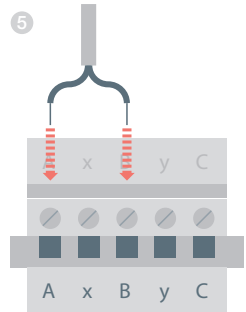

# Wireless Cylinder Thermostat (CS92) *continued*



## To fit the CS92 Insertion Sensor

- 1 Fit in the cylinder immersion well with suitable fittings to provide strain relief and prevent accidental removal
- 2 If the sensor doesn't fit tightly in the immersion well fill the space with heat-conductive compound to ensure maximum heat transfer
- 3 Install the CS92 Transceiver in a suitable location close enough for the cable from the sensor to reach
- 4 Connect the cable from the sensor to the CS92 Transceiver

Wire to CS92 Transceiver

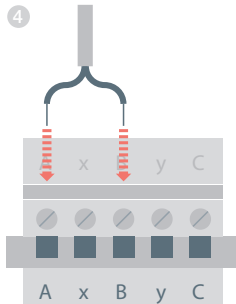



---

## Remote Access Gateway (RFG100)

---



### If you're fitting a Remote Access Gateway (RFG100)

- 1 Connect the Remote Access Gateway to the home's internet router using the ethernet cable supplied

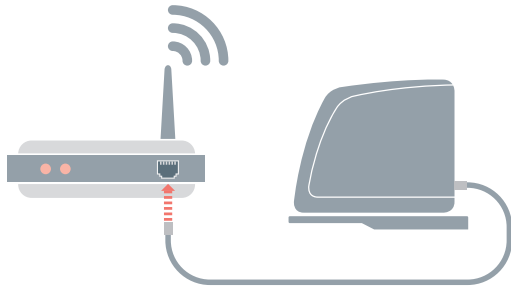

## Mixing Valve Controller (HM80), Underfloor Heating Controller (HCE80/HCC80), OpenTherm Bridge (R8810)

---



If you're fitting a Mixing Valve Controller (HM80), Underfloor Heating Controller (HCE80/HCC80), OpenTherm Bridge (R8810)



Refer to the installation instructions supplied with each device

---

# Step 2: Set up your evohome Controller

The **evohome** Controller has a guided configuration process to help you set up the zones for a single type of system. For mixed systems (i.e. Under Floor Heating zones plus Radiator zones) use Guided Configuration for the larger system then “Add Zones” in the installer menu.

To add a stored hot water system use the guided configuration Stored Hot Water option in the installer menu.

The following instructions cover the full configuring process for a zone, but if you are using Guided Configuration your **evohome** Controller will give you on-screen instructions to bind the other components to the **evohome** Controller – just follow the bind instruction for each device in this manual.

---

## In this section

Powering up your **evohome** Controller

10

---

## Powering up your evohome Controller



Your **evohome** Controller comes with \*rechargeable batteries which are pre-charged allowing you to set-up the system while off the table stand or wall bracket.

Place the **evohome** Controller on the table stand or wall bracket for normal use.

\*Only use the AA rechargeable batteries provided

### First, power up the **evohome** Controller

- 1 Remove the cover, remove the battery tab and replace the cover
- 2 Place it on the table stand or wall bracket
- 3 Once the batteries are fully charged, the evohome Controller can be easily removed from the table stand or wall bracket for ease of programming. After 30 minutes the evohome Controller will emit a beep to indicate that it should be replaced on the stand or wall bracket

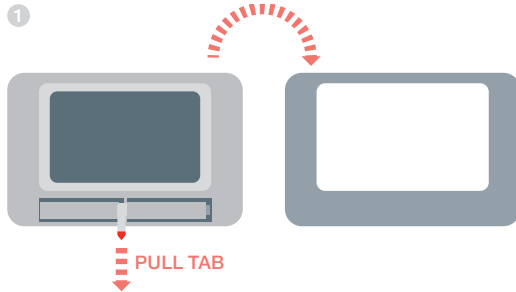

---

## Then to set up the **evohome** Controller

- 1 Follow the on-screen instructions to set up the language, date and time
- 2 Now choose the correct option for the system you're installing:



For a **Base Pack** or a **Connected Pack** and NO additional devices we recommended pressing 'Home' – then go to "Step 4: System test" on page 29.



For a **Base Pack** or a **Connected Pack**, PLUS un-bound devices we recommended pressing 'Installation Menu' to add the un-bound devices – follow "Step 3: Power up and bind devices" on page 13.



For an un-bound **evohome** Controller, plus un-bound devices we recommended pressing 'Guided Configuration' to add the un-bound devices – follow "Step 3: Power up and bind devices" on page 13.

---



---

# Step 3: Power up and bind devices

If you bought a Base Pack or a Connected Pack only — your devices are already bound. Go to Step 4.

If you bought an unbound evohome Controller, plus other devices and are using 'Guided Configuration' follow the instructions on your evohome Controller screen and use this section to put the devices into binding mode.

If you bought a Base Pack or a Mobile Connected Pack, plus other devices, you need to power up all devices and then bind them to the evohome Controller using the 'Installation Menu'. It may be easier to power up and bind some devices while they're close to the evohome Controller – you can install them in their assigned zones later.

Follow the instructions for the device(s) you're going to bind. When you bind a device to the evohome Controller the devices permanently store the connection and there should never be a need to rebind them even after a power cut.

---

## In this section

Radiator Controllers (HR92)	14
Wireless Cylinder Thermostat (CS92)	16
Remote Access Gateway (RFG100)	18
Wireless Relay Box (BDR91)	19
Radiator Controller (HR80)	22
Underfloor Heating Controller (HCE80 or HCC80)	24
Mixing Valve Controller (HM80)	27



---

## Radiator Controllers (HR92)



**evohome  
Controller**

If you are NOT following GUIDED CONFIGURATION follow these steps on your **evohome** Controller display first:







1. Press and hold 'Settings'  for 3 seconds
2. Press the green tick 
3. Press ADD ZONE
4. Press the zone you want to add the Radiator Controller to
5. Rename the zone if required and/or press the green tick 
6. Press RADIATOR VALVE
7. If you want to control the zone temperature with the evohome Controller (which needs to be located in that zone) press YES, otherwise press NO.

You must repeat these steps for each radiator controller.



### Power up and bind Radiator Controllers (HR92) – Your evo Zone Kit

#### Bind the Radiator Controllers (HR92)

- 1 Remove the circular top cover
- 2 Open the battery clip and insert the AA batteries supplied
- 3 Close the clip and replace the cover
- 4 Press the  button once – it should say UNBOUND
- 5 Press and hold the  button for a further 5 seconds until it says BIND
- 6 Press the  button once – it should say BINDING
- 7 You should receive a SUCCESS message on the evohome Controller (if not go back and re-bind)
- 8 The name of the allocated zone should appear on the HR92 display when you press the  button
- 9 Either press the green tick  to add another radiator to the zone. Or press the red cross  if you don't need to add another radiator to the zone

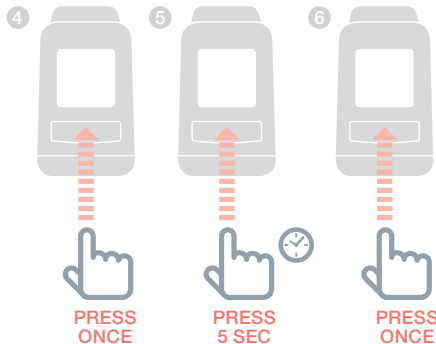
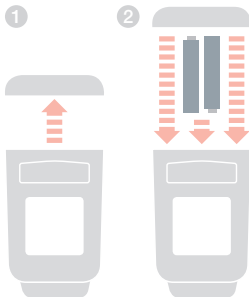





## Install the Radiator Controllers (HR92)

- 1 Locate the room (zone) for the radiator controller
- 2 Slide the locking mechanism to the unlock position
- 3 Remove the adaptor from the bottom of the controller
- 4 Unscrew the black wheel fully anticlockwise
- 5 Remove any existing control on the radiator valve
- 6 Screw the white end of the adaptor on to the radiator valve
- 7 Push the controller fully on to the adaptor with the screen facing towards you
- 8 Slide the locking mechanism to the locked position

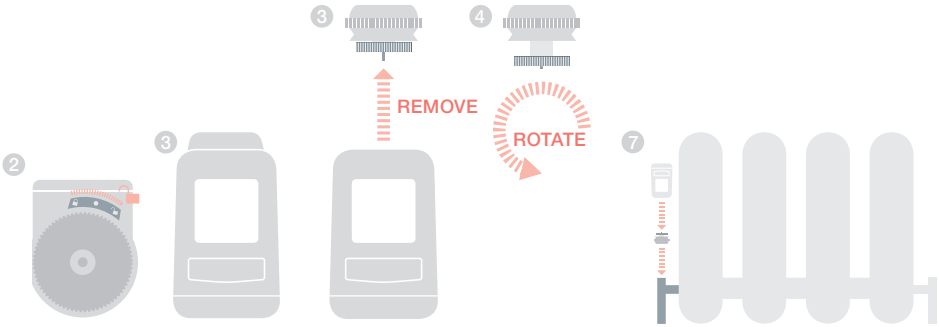



## Wireless Cylinder Thermostat (CS92)



**evohome  
Controller**

If you are NOT following GUIDED CONFIGURATION follow these steps on your **evohome** Controller display first:

1. Press and hold "Settings"  for 3 seconds
2. Press the green tick 
3. Select GUIDED CONFIGURATION
4. Press STORED HOT WATER CONFIGURATION
5. Press the green tick 



### Power up and bind a Wireless Cylinder Thermostat Transceiver (CS92)

#### On the CS92 Transceiver

- 1 Remove the CS92 Transceiver cover
- 2 Remove the battery tab and replace the cover
- 3 On the CS92 Transceiver press and hold the button for 5 seconds. The green light should come on and the red light should flash
- 4 Press the button again
- 5 You should receive a SUCCESS message on the **evohome** Controller (if not go back and re-bind)
- 6 Choose the correct hot water valve type for the system you're installing and follow the on screen instructions

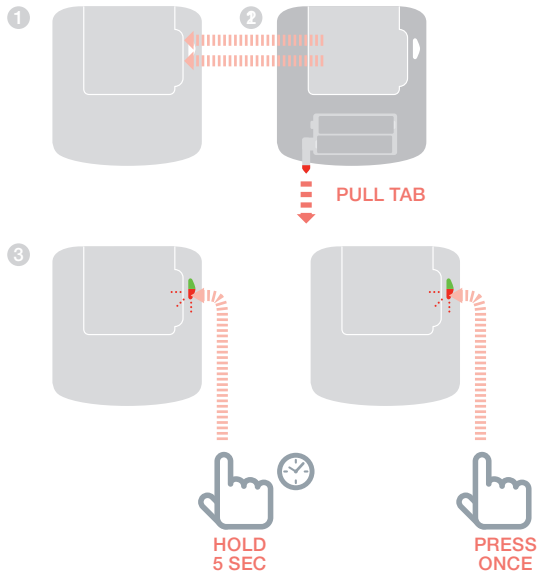

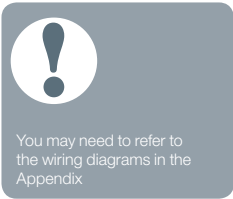

### To bind the Wireless Relay Box (BDR91)

- 1 On the Wireless Relay Box, press and hold the button for 15 seconds (until the red LED blinks rapidly) to clear any previous binding data
- 2 Press and hold the button again for 5 seconds (until the red LED blinks slowly)
- 3 On the evohome Controller press the green bind button 
- 4 You should receive a SUCCESS message on the evohome Controller (if not go back and re-bind)

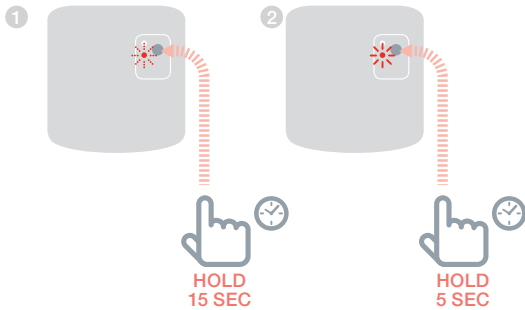

## Remote Access Gateway (RFG100)





If the Gateway was in the Connected Pack with **evohome**, it is already bound and there is no need follow these binding instructions.



### evohome Controller

If you are NOT following GUIDED CONFIGURATION follow these steps on your **evohome** Controller display first:



1. Press and hold "Settings"  for 3 seconds
2. Press the green tick 
3. Select ADD GATEWAY



### Power up and bind a Remote Access Gateway (RFG100)

Connect the Gateway to the power supply and turn on the power.

#### To bind the Remote Access Gateway (RFG100)

- 1 Press and hold the button on the base of the gateway unit until you see a flashing light next to the 
- 2 On the evohome Controller press the green bind button 
- 3 You should receive a SUCCESS message on the evohome Controller (if not go back and re-bind)

Now you need to set up a user account and download the smartphone app.

Go to **[www.mytotalconnectcomfort.com](http://www.mytotalconnectcomfort.com)** and follow the instructions there.

1

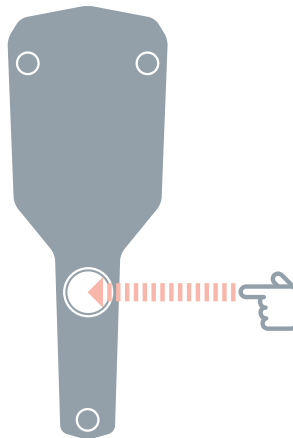

## Wireless Relay Box (BDR91)



### evohome Controller

If you are NOT following GUIDED CONFIGURATION follow these steps on your **evohome** Controller display first:

1. Press and hold 'Settings' for 3 seconds
2. Press the green tick
3. Press SYSTEM DEVICES
4. Press the button next to 'Boiler Demand'
5. Press BOILER RELAY or OPENTHERM BRIDGE



## Power up and bind a Wireless Relay Box (BDR91) or OpenTherm Bridge (R8810) to control a boiler



Make sure the Wireless Relay Box (BDR91) or OpenTherm Bridge (R8810) is wired to the boiler and powered up.

### To bind a Relay Box or OpenTherm Bridge

- 1 Press and hold the button for 15 seconds (until the red LED blinks rapidly) to clear any previous binding data
- 2 Press and hold the button again for 5 seconds (until the red LED blinks slowly)
- 3 On the evohome Controller press the green bind button 
- 4 You should receive a SUCCESS message on the evohome Controller (if not go back and re-bind)

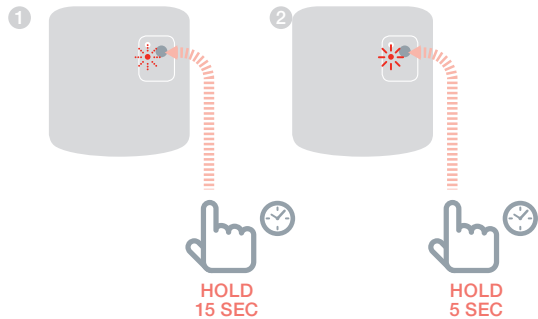



## Wireless Relay Box (BDR91) *continued*



### evohome Controller

If you are NOT following GUIDED CONFIGURATION follow these steps on your **evohome** Controller display first:

1. Press and hold "Settings"  for 3 seconds
2. Press the green tick
3. Press ADD ZONE
4. Press the zone you want to add the controller to
5. Rename the zone if required and/or press the green tick 
6. Press ZONE VALVES



### Power up and bind a Wireless Relay Box (BDR91) to control a Zone Valve

Make sure the Wireless Relay Box (BDR91) is wired to the Zone Valve and powered up.

If you want to control the zone temperature with the **evohome** Controller (the **evohome** Controller needs to be located in that zone) press YES, otherwise press NO and bind a sensor – either Digital Room Thermostat (DTS92) or Room Temperature Sensor (HCW82/HCF82).



### To bind the Digital Room Temperature Sensor (DTS92)

- 1 Press and hold the power button for 2 seconds to put the unit into standby
- 2 Press the up and down arrows together for three seconds – it should say INst
- 3 Press the down arrow – it should say COnt
- 4 Press the up arrow three times – it should say CLr
- 5 Press the power button once to clear any previous binding data
- 6 Press the up arrow – it should say COnt
- 7 Press the power button once to send the binding signal to the evohome Controller
- 8 You should receive a SUCCESS message on the evohome Controller (if not go back and re-bind)

2



**HOLD  
3 SEC**



### To bind a Room Temperature Sensor (HCW82 or HCF82)



- 1 Press the bind button on the bottom right hand corner of the unit once. The red LED light will flash
- 2 You should receive a SUCCESS message on the evohome Controller (if not go back and re-bind)

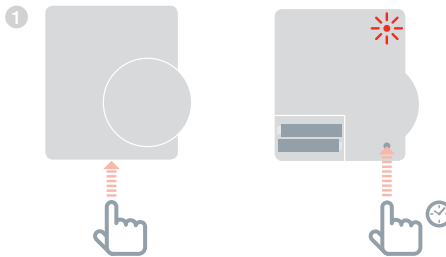

### Then, on the Wireless Relay Box (BDR91)

- 1 Press and hold the button for 15 seconds (until the red LED blinks rapidly) to clear any previous binding data
- 2 Press and hold the button again for 5 seconds (until the red LED blinks slowly)
- 3 On the evohome Controller press the green bind button 
- 4 You should receive a SUCCESS message on the evohome Controller (if not go back and re-bind)

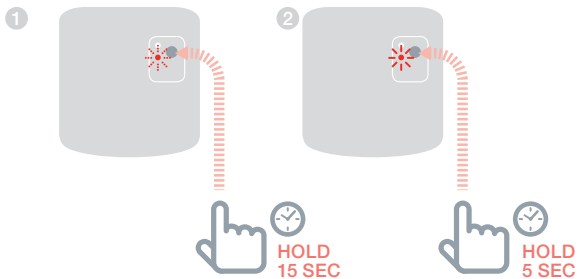

## Radiator Controller (HR80)



### evohome Controller

If you are NOT following GUIDED CONFIGURATION follow these steps on your **evohome** Controller display first:

1. On the evohome Controller press and hold "Settings" ⚙️ for 3 seconds
2. Press the green tick ✓
3. Press ADD ZONE
4. Press the zone you want to add the controller to
5. Rename the zone if required and/or press the green tick ✓
6. Press RADIATOR VALVE



## Power up and bind a Radiator Controller (HR80)

If you want to control the zone temperature with your **evohome** Controller (the **evohome** Controller needs to be located in that zone) press YES, otherwise press NO and bind the sensor.

### On the HR80, you need to bind the sensor and actuator separately

- 1 Power up the Radiator Controller (see HR80 instructions)

#### To bind the sensor

- 2 On the evohome Controller press the green bind button (→) (←)
- 3 Turn release clips on each side of the Radiator Controller to remove the bottom plate
- 4 On the underside of the Radiator Controller press the recessed bind button
- 5 The Radiator Controller screen should briefly show a flashing RF icon (📶) then SYNC when successful. The evohome Controller will also show if binding was successful (if not go back and re-bind)

4

SIDE VIEW





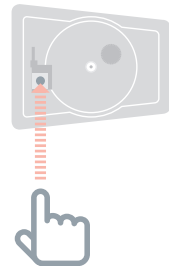

BOTTOM VIEW





### To bind the actuator



- 6 Press the bind button on the Radiator Controller (if there are multiple HR80's in the zone, do this to all of them). The screen should show a flashing RF icon 
- 7 On the evohome Controller press the green bind button 
- 8 Check that (all) the Radiator Controllers display SYNC. If a Radiator Controller does not display SYNC and the flashing RF icon  remains, press back on the evohome Controller and send the bind signal again
- 9 Press the next arrow on the evohome Controller
- 10 Press the green tick  to add another radiator to the zone — OR — Press the red cross  if you don't need to add another radiator to the zone

## Underfloor Heating Controller (HCE80 or HCC80)



### evohome Controller

If you are NOT following GUIDED CONFIGURATION follow these steps on your **evohome** Controller display once the underfloor heating controller and sensors have been fitted:

1. On the evohome Controller press and hold "Settings"  for 3 seconds
2. Press the green tick 
3. Press ADD A ZONE
4. Press the zone you're adding the controller to then select UNDERFLOOR HEATING
5. You need to install a sensor (HCW82, HCF82, DTS92) in each zone controlled by the underfloor heating controller and bind it to the evohome Controller.

You need to repeat this process for every zone that uses underfloor heating.



Make sure the zone you're adding on the **evohome** Controller corresponds to the correct underfloor heating zone.



### Power up and bind an Underfloor Heating Controller (HCE80 or HCC80)

If you want to control the zone temperature with your **evohome** Controller (the **evohome** Controller needs to be located in that zone) press YES, otherwise press NO and bind a sensor – either Digital Room Thermostat (DTS92) or Room Temperature Sensor (HCW82/HCF82).



### To bind the Digital Room Temperature Sensor (DTS92)

- 1 Press and hold the power button for 2 seconds to put the unit into standby
- 2 Press the up and down arrows together for three seconds – it should say INst
- 3 Press the down arrow – it should say COnt
- 4 Press the up arrow three times – it should say CLR
- 5 Press the power button once to clear any previous binding data
- 6 Press the up arrow – it should say COnt
- 7 Press the power button once to send the binding signal to the evohome Controller
- 8 You should receive a SUCCESS message on the evohome Controller (if not go back and re-bind)

2



**HOLD  
3 SEC**



## To bind a Room Temperature Sensor (HCW82 or HCF82)



- 1 Press the bind button on the bottom right hand corner of the unit once. The red LED light will flash
- 2 You should receive a SUCCESS message on the evohome Controller (if not go back and re-bind)

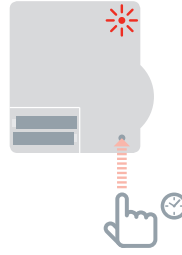
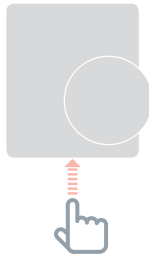

1



CONTINUED ON NEXT PAGE



## Underfloor Heating Controller (HCE80 or HCC80) *continued*

### Then on the underfloor controller

- 1 Press the bind button  until the bind button light comes on and the zone number light flashes red
- 2 On the evohome Controller, press the green bind button 

**If the zone light turns solid green the binding is successful**

**If the zone light turns solid red continue with these instructions**

- 3 Press the back arrow on the evohome Controller
- 4 Press the bind button  on the Underfloor Heating Controller – the zone light should flash green
- 5 On the evohome Controller, press the green bind button 
- 6 The zone light on the Underfloor Heating Controller should now be solid green
- 6 You should receive a SUCCESS message on the evohome Controller (if not go back and re-bind)

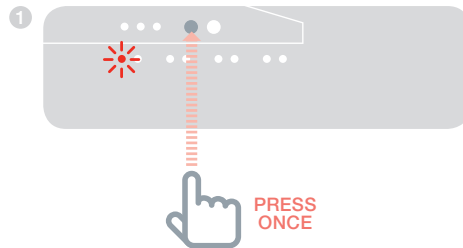

## Mixing Valve Controller (HM80)



### evohome Controller

If you are NOT following GUIDED CONFIGURATION follow these steps on your **evohome** Controller display once the Mixing Valve Controller and sensor have been installed:

1. On the evohome Controller press and hold "Settings" ⚙️ for 3 seconds
2. Press the green tick ✓
3. Select ADD A ZONE
4. Select the zone you're adding the controller to then select MIXING VALVE
5. If you want to control the zone temperature with your evohome Controller (the evohome Controller needs to be located in that zone) YES, otherwise press NO and bind the sensor.



### Power up and bind a Mixing Valve Controller (HM80)

A Mixing Valve Controller should only be fitted by a qualified fitter. Unless you're using the **evohome** Controller as a sensor, you need to install a sensor (HCW82, HCF82 or DTS92) before binding the controller to the **evohome** Controller.



### To bind the Digital Room Temperature Sensor (DTS92)

- 1 Press and hold the power button for 2 seconds to put the unit into standby
- 2 Press the up and down arrows together for three seconds – it should say INst
- 3 Press the down arrow – it should say COnt
- 4 Press the up arrow three times – it should say CLr
- 5 Press the power button once to clear any previous binding data
- 6 Press the up arrow – it should say COnt
- 7 Press the power button once to send the binding signal to the evohome Controller
- 8 You should receive a SUCCESS message on the evohome Controller (if not go back and re-bind)

2



HOLD  
3 SEC

CONTINUED ON NEXT PAGE



### To bind a Room Temperature Sensor (HCW82 or HCF82)



- 1 Press the bind button on the bottom right hand corner of the unit once. The red LED light will flash
- 2 You should receive a SUCCESS message on the evohome Controller (if not go back and re-bind)

1

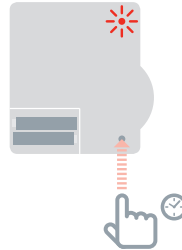
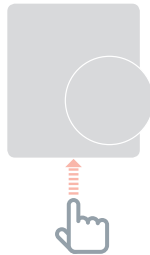

### Then on the Mixing Valve Controller

- 1 Press and hold both buttons on the Mixing Valve Controller for 4 seconds until the red light flashes
- 2 On the evohome Controller press the green bind button 
- 3 You should receive a SUCCESS message on the evohome Controller (if not go back and re-bind)

1



**PRESS  
AND HOLD  
4 SEC**

---

# Step 4: System test

Now that all the devices are bound to your evohome Controller and installed in their final locations, check that the system works properly and that all the devices are responding to commands from the evohome Controller.

You can perform a simple functional check of the heating system by overriding the temperature of each zone to their minimum and maximum while listening for a response from the radiator (or zone) controllers and boiler. To save power the battery devices only communicate with the evohome Controller every four minutes therefore the system may not respond immediately to a manual temperature change.

---

## In this section

### Advanced RF communication check

Mains Powered Wireless Devices

Battery Powered Wireless Devices

30

30

31

---

## Advanced RF communication check



To save power the battery devices only communicate with the **evohome** Controller every four minutes therefore the system may not respond immediately to a manual change.

To check the RF signal strength between the wireless devices and the **evohome** Controller go to RF COMMS CHECK in the **evohome** Controller Installer Menu and test each wireless device.

- 1 On the evohome Controller press and hold 'Settings' for 3 seconds
- 2 Press the green tick 
- 3 Press RF COMMS CHECK
- 4 Choose the devices you want to test

### Mains Powered Wireless Devices

Mains powered devices do not need to be put into test mode and will automatically respond to the test message sent from the **evohome** Controller:



#### Wireless Relay Box (BDR91)

- The Relay Box will flash the green LED from 1 flash (poor) to 5 flashes (excellent) – no flashing means the Relay Box has not received a test signal from the evohome Controller



#### Remote Access Gateway (RFG100)

- The Gateway will flash the green LED from 1 flash (poor) to 5 flashes (excellent) – no flashing means the Gateway has not received a test signal from the evohome Controller



#### Underfloor Heating Controller (HCE80/HCC80)

- The Underfloor Heating Controller will flash the green LED for the zone you are testing from 1 flash (poor) to 5 flashes (excellent) – no flashing means the Underfloor Heating Controller has not received a test signal from the evohome Controller





## Battery Powered Wireless Devices

Battery powered devices need to be put into test mode to send and receive a test signal:



### Radiator Controller (HR92)

- 1 Press the  button, the zone name is displayed
- 2 Press and hold the  button again for 5 seconds
- 3 Turn the dial to display RF CHECK
- 4 Press the  button

The **evohome** Controller will display the signal strength (poor to excellent) and the Radiator Controller will display a signal strength bar and a rating from 1 (poor) to 5 (excellent) – 0 means the Radiator Controller has not received a test signal from the **evohome** Controller.

- 5 To exit test mode turn the dial to exit and press the  button. It will exit automatically after 10 minutes.

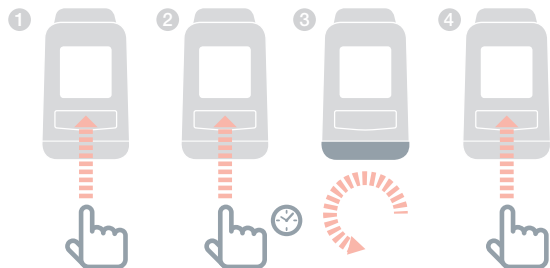

---

## Advanced RF communication check *continued*

---



### Radiator Controller (HR80)

- 1 Separate the Radiator Controller from the adaptor on the radiator
- 2 Turn the adjustment dial clockwise (approx two full rotations) until TEST is displayed

The **evohome** Controller will display the signal strength (poor to excellent) – nothing on the **evohome** Controller display means the Radiator Controller has not received a test signal from the **evohome** Controller.

- 3 To exit test mode remove and reinsert the batteries from the Controller. It will exit automatically after 5 minutes.

---

2

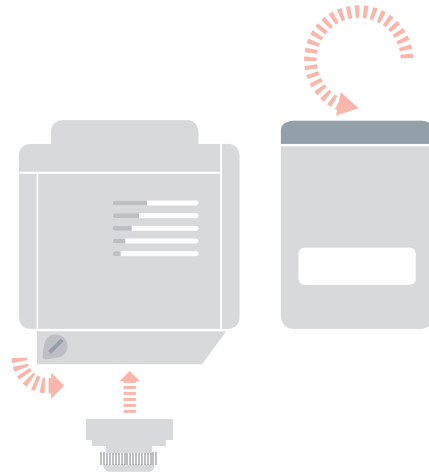



### Digital Room Thermostat (DTS92)

- 1 Put Room Thermostat into standby mode (show icon)
- 2 Press up and down together for 3 seconds
- 3 Press down once, the display should say CONT
- 4 Press down for 3 seconds, the display should say TEST

The **evohome** Controller will display the signal strength (poor to excellent) and the Room Thermostat will display a signal strength rating from 1 (poor) to 5 (excellent) – 0 means the Room Thermostat has not received a test signal from the **evohome** Controller.

- 5 To exit test mode, press off on Room Thermostat for 5 seconds. It will exit automatically after 10 minutes.

2



PRESS FOR  
3 SECONDS

---

## Advanced RF communication check *continued*

---



### Room Temperature Sensor (HCF82 or HCW82)



- 1 Remove the cover from the sensor
- 2 Press and hold the bind button until the red LED goes off (approx 30 seconds)
- 3 The red LED will flash each time it sends a test message

The **evohome** Controller will display the signal strength (poor to excellent) – no flashing means the Temperature Sensor has not received a test signal from the **evohome** Controller.

- 4 To exit test mode, press the bind button on the Temperature Sensor. It will exit automatically after 5 minutes.

1

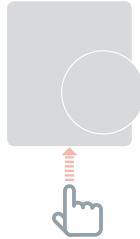

2

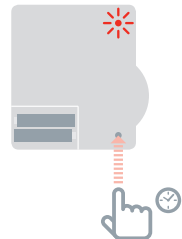

**PRESS FOR  
30 SECONDS**

---



### Wireless Cylinder Thermostat (CS92A)

- 1 Press the button on the Cylinder Thermostat transceiver
- 2 The green light should come on. If it doesn't, reinsert the batteries and try again

The **evohome** Controller will display the signal strength (poor to excellent) and the transceiver should flash the red LED from 1 flash (poor) to 5 flashes (excellent) – no flashing means the transceiver has not received a test signal from the **evohome** Controller.

To exit test mode press the button on the transceiver.

1

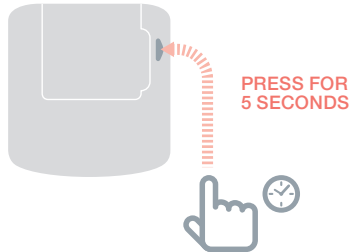



---

# Configuration and modification

Once you've completed these steps you're ready to start using evo. You can also make parameter adjustments in the evohome Controller to match the exact requirements of the heating system. The operation and functions of the each zone can also be adjusted. These can be found in the Installer Menu.

Components can be added or replaced by editing the zones or system in the Installer menu.

---

## In this section

Parameters and control features	38
Adding and replacing components in an existing system	39

---

## Parameters and control features

---

Once you've completed these steps you're ready to start using evo. The user guide gives you instructions for personalising the settings on the **evohome** Controller.

You can also make parameter adjustments on your **evohome** Controller to match the exact requirements of the heating system. These can be found in the Installer Menu.

- ① On the evohome Controller press and hold 'Settings' for 3 seconds
- ② Press the green tick 
- ③ Press PARAMETER SETTINGS and choose the parameter you want to adjust:
  - Internal Sensor Offset
  - Cycle Rate
  - Minimum On Time
  - Fail Safe
  - Optimisation
  - Hot Water Parameters

For more details on parameters visit [www.evohome.honeywell.com](http://www.evohome.honeywell.com)

---



---

## Adding and replacing components in an existing system

---

### Adding and replacing components in an existing system

- 1 On the evohome Controller press and hold "Settings" for 3 seconds
- 2 Press the green tick 
- 3 To change a device in a zone press ZONE SETTINGS and select the zone name To add or change an actuator
- 4 Press the application button then next and follow the instructions to bind a new actuator
- 5 To change the sensor press the sensor button, select the type of sensor or next and follow the instructions to bind a sensor. If the old product is not required in the system remember to remove the batteries at it may still try to communicate with the system.

### To change a boiler relay, system valve, hot water component or remote gateway

- 1 Press SYSTEM DEVICE
  - 2 Select the type of device and follow the instructions to bind. If the old product is not required in the system remember to remove the power at it may still try to communicate with the system.
-



# Appendix

Wiring diagrams, heating system schematics

---

## In this section

Sample evo systems	42
Wiring diagrams	44
Safety information	48
<b>evohome</b> Controller technical data	49

---

## Sample evo systems

### Single zone

The **evohome** Controller is the sensor for the whole home which is controlled to the same time and temperature schedule.

This system also includes wireless connectivity, which is available for any configuration.

Figure 1 Single zone system

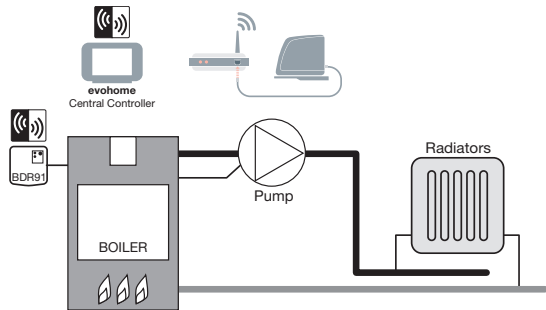

### Honeywell S plan 2 two-port valves

There are two zone valves – one for stored hot water one for central heating. The **evohome** Controller is the sensor for the whole home which is controlled to the same time and temperature schedule. The valves open when needed. The boiler is operated via a wired junction box.

Figure 2 Honeywell S plan

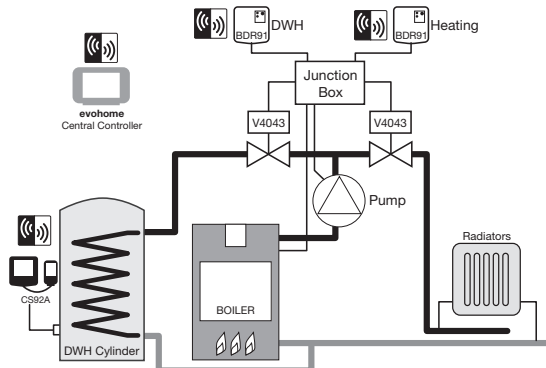

!

If a system has been set up and the relays are moved to a new function, the relay binding must be cleared or it will continue to carry out its original function.

Figure 3 Honeywell Y plan

## Honeywell Y plan 1 three-port mid-position valve

The operation is identical to the S plan but it uses a single three-port or mid position valve.

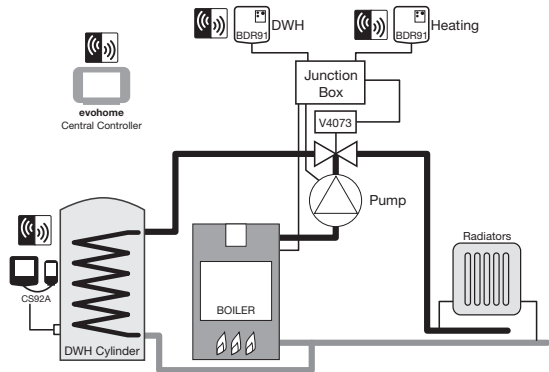
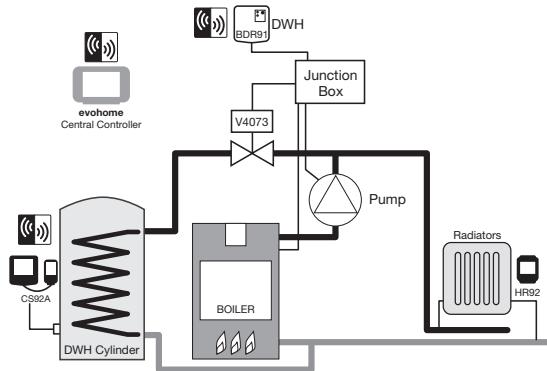

Figure 4 Stored hot water and zoned heating system. This system needs HR92s or other zoning solutions for the radiators.



# Wiring diagrams

## Connecting a wireless boiler relay

**Figure 5** Wiring for a basic boiler (not requiring a pump overrun). The relay powers the boiler live input.

### A basic boiler

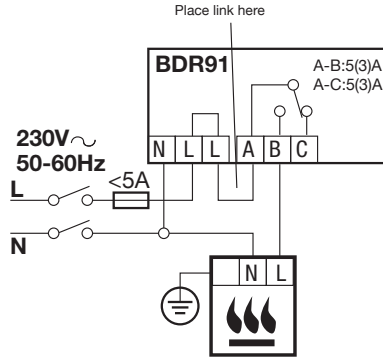

### A boiler that requires a permanent live

For use with boiler that require a permanent live (this is a typical Combi boiler wiring) but please check manufactures instructions. This can be used for boilers with low voltage or 230vac room thermostat inputs.

**Figure 6** Boiler that requires a permanent live

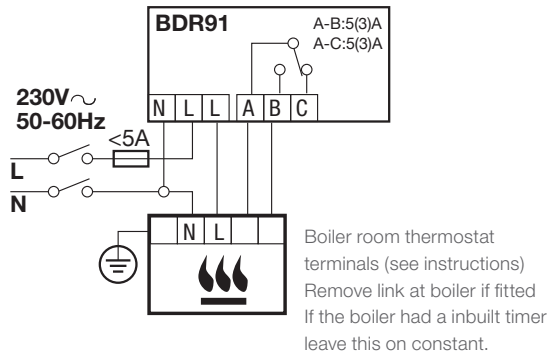



# Wiring diagrams *continued*

**Figure 9** Two port valves with a wired boiler. If a wireless boiler relay is used the Grey, Orange and feed to pump and boiler are not required.

## Sundial or system valves

### S Plan: 2 two-port valves with a wired boiler

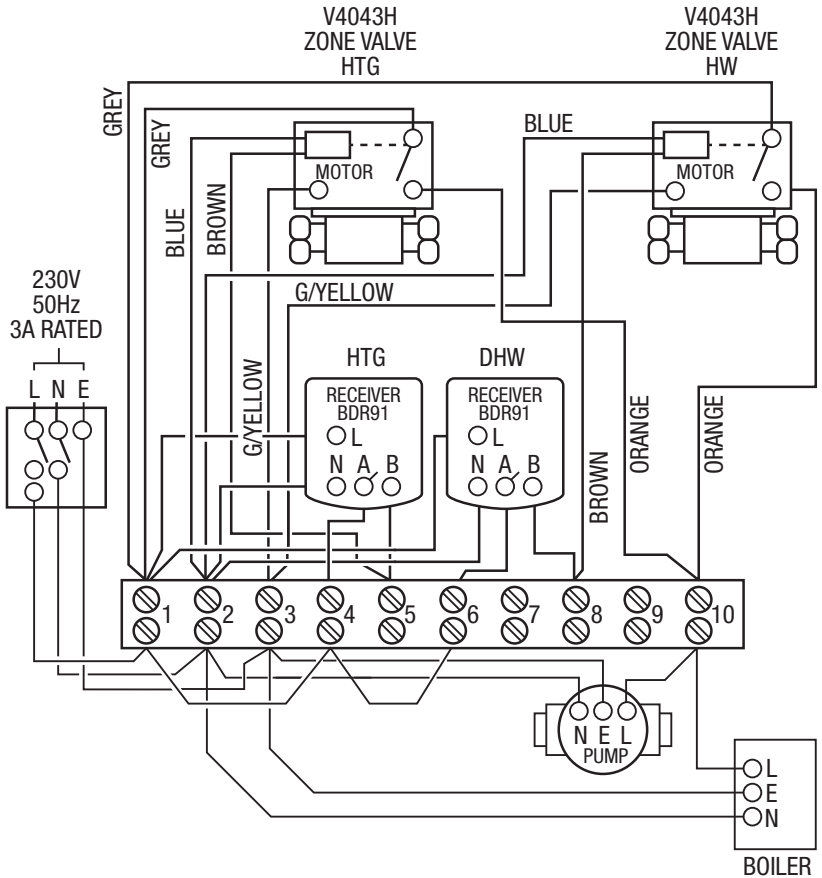

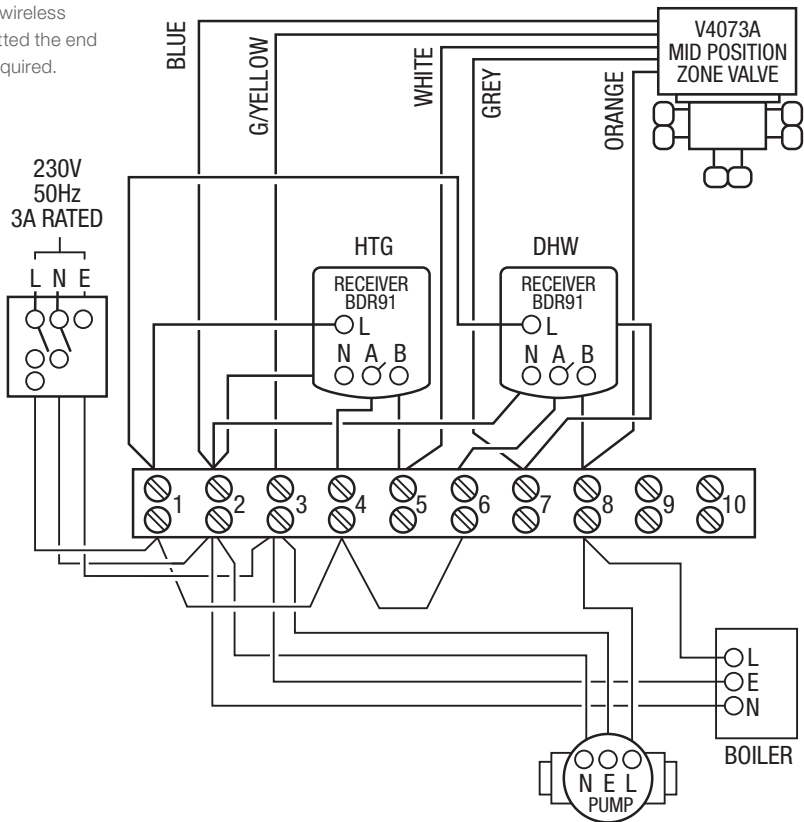

**Figure 10** Mid position (3 port) valve

G/Yellow: Earth wire  
 BLUE: Motor Neutral  
 WHITE: Heating relay  
 GREY: Hot water relay  
 ORANGE: End switch (If used). In wired system this typically feeds the boiler. When a wireless boiler relay is fitted the end switch is not required.

**Y Plan: Three-port Mid position valve with a wired boiler**

If a wireless boiler relay is used the Orange and feed to pump and boiler are not required.



## Safety information

### Approvals

Conforms to protection requirements of the following directives:

EMC: 2004/108/EC

LVD: 2006/95/EC

R&TTE: 1999/05/EC

Hereby, Honeywell, declares that this **evohome** Controller is in compliance with the essential requirements and other relevant provisions of Directive 1999/5/EC.

### EMC compliance considerations

Refer to Code of Practice standards EN61000-5-1 and -2 for guidance.

Caution: Isolate power supply and make safe before wiring the unit to prevent electric shock and equipment damage. Installation should be carried out by a competent person.

### Location of device

**evohome** Controller should be installed in an open space for best performance as it is a radio frequency device. Leave at least 30cm distance from any metal objects including wall boxes and at least 1 metre from any other electrical equipment eg. radio, TV, PC etc. Do not mount onto metal wall boxes.

For the best temperature control performance the **evohome** Controller should not be placed near heat or cool sources (e.g. cooker, lamp, radiator, doorways, windows).

### Disclaimer

This product and its associated documentation and packaging are protected by various intellectual property rights belonging to Honeywell Inc and its subsidiaries and existing under the laws of the UK and other countries. These intellectual and property rights may include patent applications, registered designs, unregistered designs, registered trademarks, unregistered trademarks and copyrights.

Honeywell reserves the right to modify this document, product and functionality without notice. This document replaces any previously issued instructions and is only applicable to the product(s) described.

This product has been designed for applications as described within this document. For use outside of the scope as described herein, refer to Honeywell for guidance. Honeywell cannot be held responsible for misapplication of the product(s) described within this document.

### PLEASE RESPECT YOUR ENVIRONMENT!

Take care to dispose of this product and any packaging or literature in an appropriate way.



#### WEEE directive 2002/96/EC

Waste Electrical and Electronic Equipment directive

- At the end of the product life dispose of the packaging and product in a corresponding recycling centre.
- Do not dispose of the unit with the usual domestic refuse.
- Do not burn the product.
- Remove the batteries.
- Dispose of the batteries according to the local statutory requirements and not with the usual domestic refuse.

---

## evohome evohome Controller technical data

---

### Electrical

---

Power module	Input voltage: 230VAC *10% Output voltage: 4VDC *0.2V, max 26W
Room unit power supply input	4VDC $\pm$ 0.2V, max. 2.6W
Low voltage cable length (max)	10m, 1.0mm <sup>2</sup> ; 5m, 0.5mm <sup>2</sup>
Battery type (rechargeable)	Type AA 1.2V NiMH 2000-2400mAh

---

### RF Communication

---

RF operation band	ISM (868.0—870.0) MHz, RX Class 2
RF communication range	30m in a residential building environment

---

### Environmental and Standards

---

Operating temperature	0 to 40°C
Storage temperature	-20 to +50°C
Humidity	10 to 90% relative humidity non condensing
IP Protection Class	IP30

---

### Mechanical

---

Dimensions	139 x 101 x 21mm (WxHxD)
------------	--------------------------

---

**evohome** is designed to convert a system with single zone pipework into a multi zone system, resulting in optimal control and comfort combined with maximum energy saving.

For more information on Smart Heat Zoning for your home, visit:

**[www.evohome.honeywell.com](http://www.evohome.honeywell.com)**



Manufactured for and on behalf of the Environmental and Combustion Controls Division of Honeywell Technologies Sàrl, ACS-ECC EMEA, Z.A. La Pièce 16, 1180 Rolle, Switzerland by its Authorised Representative Honeywell Inc.

**Honeywell Control Systems Ltd.**

Skimped Hill Lane,  
Bracknell  
Berkshire  
RG12 1EB  
[www.honeywelluk.com](http://www.honeywelluk.com)

50040745-201 A  
© 2013 Honeywell International Inc.

---