

# VALENCIA Radiator Valve Range

## PRODUCT DATA SHEET



## Application

Thermostatic Radiator Valves (TRVs) provide local control of room temperatures to maintain comfort and save energy. TRVs sense the air temperature around them and control the flow of water through the radiator to which they are fitted, to maintain and limit the temperature within the room.

Air from the room passes over the sensor of the TRV causing the liquid to expand as the temperature rises. The sensor acts onto the valve spindle causing the TRV insert to close.

When the temperature falls, the liquid contracts and the spring-loaded valve spindle opens. Only the amount of water required to maintain the room temperature set on the radiator thermostat will flow into the radiator.

New research carried out on behalf of TACMA, the Controls Association within BEAMA, shows that, in a typical UK house, heating system energy consumption can be reduced by up to 40% through the installation of TRVs in addition to a Room Thermostat or Programmable Room Thermostat and that installation costs could be recovered within a year.

These tests also showed that by providing local temperature control in every room, TRVs can significantly improve comfort for householders by providing better heat distribution around a dwelling, not achieved without TRVs, even if the system is correctly balanced.

## Features

- All Valencia TRVs are 'A' Rated for efficiency using liquid sensors to provide consistent and longer lasting performance
- The TRV head may be mounted vertically or horizontally by swapping the tailpiece and pipe fittings
- The Valencia Valve bodies are fully compatible with a wide range of other Honeywell TRV heads offering alternative finishes, remote sensor and Vandal resistant versions as well as the Evohome electronic TRV head
- All Valencia valve bodies allow bi-directional water flow which means that valves can be installed without the need to adjust the insert flow direction after installation
- Quiet operation
- Straight and Angled bodies with 15mm, 10mm or 8mm compression connections or 10mm Pushfit fittings are available
- 6mm play on radiator tailpiece to allow for variation in radiator distance from the valve.
- The integrated balancing insert allows the system to be balanced and remain balanced when radiator is removed for decorating or replacement.

## Specification

- European Standard EN 215 and Keymark approved
- Suitable for heating water quality to VDI2035
- VT117/VTL120 setting range : 1 – 26°C
- VT200/VTL200 setting range : 6 – 26°C
- TRV Head connection size : M30 x 1.5mm
- Closing dimension: 11.5 mm
- Stroke: 2,5 mm
- Specific stroke (TRV head): 0.22 mm/K
- Maximum Water Temperature: 130°C
- Maximum Water Pressure: 10 bar
- Maximum Differential Pressure: 1.0 bar
- Max DP to ensure quiet operation: 0.2 bar
- DN15 angle kvs: 1.57 m3/h
- DN15 straight kvs: 0.87 m3/h
- Nominal flow: 190 kg/h

### Please Note:

- Heating system water quality should conform with VDI-Guideline 2035
- Additives must be suitable for EPDM seals
- The system must be flushed with all valves fully open

## Design

### TRV head:

- Plastic Handwheel (T200 has a chrome plated metal cap)
- VT200/VTL200 metal-plated chrome or brushed metal finish body variants
- Nickel or Chrome plated metal connection ring
- Internal metal liquid filled brass sensor

### TRV valve:

- Chrome plated brass angle or straight valve housing PN10 DN15
- Dimensions according EN215, appendix A, series GB
- Integrated (SLGB) balancing insert made of brass with EPDM O-rings, soft seals and stainless steel spindle
- Plastic decorators cap
- Chrome plated union nuts and radiator tailpiece
- Brass compression olives

### Lockshield valve:

- Chrome plated brass angle or straight housing PN10 DN15
- Brass insert
- Plastic protection cap
- Chrome plated union nuts and radiator tailpiece
- Brass compression olives

## EN215

	Thera-100 with liquid sensor	Thera-200 with liquid sensor	EN215 requirements
Min. setpoint temperature (*-position)	6°C (43°F)	6°C (43°F)	5...12°C (41...54°F)
Max. setpoint temperature	26°C (79°F)	26°C (79°F)	≤ 32°C (90°F)
Hysteresis	0.4K	0.25K	≤ 1.0K
Influence of differential pressure	0.4K	0.3K	≤ 1.0K
Influence of heating medium	0.9K	1.0K	≤ 1.5K
Response time	23 min.	20 min.	≤ 40 min.

NOTE: All °C- and °F-values specified at ideal incident flow. This can differ from stated values depending on installation position and air flow.

NOTE: Influence of differential pressure depends on TRV body used.

## TRV Settings

	closed	6°C	8°C	12°C	16°C	20°C	23°C	26°C
VT117 / VTL120	0	*	1	2	3	•	5	6
VT200 / VTL200	N/A	*	1	2	3	4	5	6

NOTE: Values approximate. Heating can freeze when radiator thermostats with zero-position are set at position '0'.  
Zero-position is also thermostatically controlled - when temperature falls the TRV may open.

### Classic TRV

Dimension, part numbers and descriptions

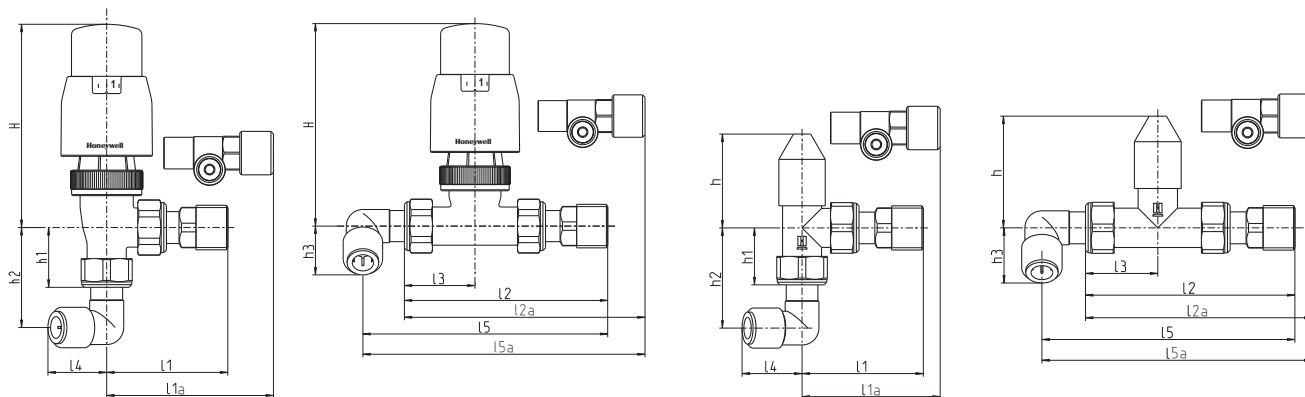

Part Number	H	h	h1	h2	h3	l1	l1a	l2	l2a	l3	l4	l5	l5a
VT200-15S	95							103		39			
VT200-15A	95		32			58							
VTL200-08A	95	45	32			58							
VTL200-10A	95	45	32			58							
VTL200-15A	95	45	32			58							
VTL200-15A-C	95	45	32			58							
VTL200-15A-D	95	45	32				69						
VTL200-15A-P	95	45	32	48		58					28		
VTL200-15A-DP	95	45	32	48			69				28		
VTL200-08S	95	52						103		39			
VTL200-10S	95	52						103		39			
VTL200-15S	95	52						103		39			
VTL200-15S-C	95	52						103		39			
VTL200-15S-D	95	52							116	39			
VTL200-15S-P	95	52			28			103		39		118	
VTL200-15S-DP	95	52			28				116	39			131

Part Number	Type	Size	Pattern	Ancillary Parts
VT200-15S	Classic TRV	15mm	Straight	
VT200-15A	Classic TRV	15mm	Angled	
VTL200-08A	Classic TRV + Lockshield	8mm	Angled	
VTL200-10A	Classic TRV + Lockshield	10mm	Angled	
VTL200-15A	Classic TRV + Lockshield	15mm	Angled	
VTL200-15A-C	Classic TRV + Lockshield	15mm	Angled	Chrome TRV Head
VTL200-15A-D	Classic TRV + Lockshield	15mm	Angled	Drain-off tailpiece
VTL200-15A-P	Classic TRV + Lockshield	10mm Pushfit Fittings	Angled	
VTL200-15A-DP	Classic TRV + Lockshield	10mm Pushfit Fittings	Angled	Drain-off tailpiece
VTL200-08S	Classic TRV + Lockshield	8mm	Straight	
VTL200-10S	Classic TRV + Lockshield	10mm	Straight	
VTL200-15S	Classic TRV + Lockshield	15mm	Straight	
VTL200-15S-C	Classic TRV + Lockshield	15mm	Straight	Chrome TRV Head
VTL200-15S-D	Classic TRV + Lockshield	15mm	Straight	Drain-off tailpiece
VTL200-15S-P	Classic TRV + Lockshield	10mm Pushfit Fittings	Straight	
VTL200-15S-DP	Classic TRV + Lockshield	10mm Pushfit Fittings	Straight	Drain-off tailpiece

### Traditional TRV

Dimension, part numbers and descriptions

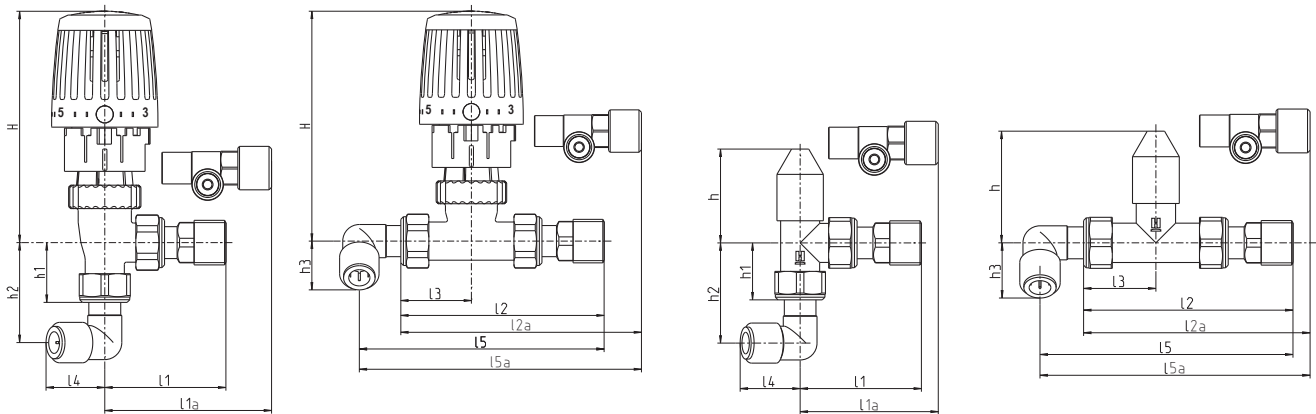

Part Number	H	h	h1	h2	h3	l1	l1a	l2	l2a	l3	l4	l5	l5a
VT117-15S	102							103		39			
VT117-15A	102		32			58							
VTL120-08A	102	45	32			58							
VTL120-10A	102	45	32			58							
VTL120-15A	102	45	32			58							
VTL120-15A-D	102	45	32				69						
VTL120-15A-P	102	45	32	48		58					28		
VTL120-15A-DP	102	45	32	48			69				28		
VTL120-08S	102	52						103		39			
VTL120-10S	102	52						103		39			
VTL120-15S	102	52						103		39			
VTL120-15S-D	102	52							116	39			
VTL120-15S-P	102	52			28			103		39		118	
VTL120-15S-DP	102	52			28				116	39			131

Part Number	Type	Size	Pattern	Ancillary Parts
VT117-15S	Traditional TRV	15mm	Straight	
VT117-15A	Traditional TRV	15mm	Angled	
VTL120-08A	Traditional TRV + Lockshield	8mm	Angled	
VTL120-10A	Traditional TRV + Lockshield	10mm	Angled	
VTL120-15A	Traditional TRV + Lockshield	15mm	Angled	
VTL120-15A-D	Traditional TRV + Lockshield	15mm	Angled	Drain-off tailpiece
VTL120-15A-P	Traditional TRV + Lockshield	10mm Pushfit Fittings	Angled	
VTL120-15A-DP	Traditional TRV + Lockshield	10mm Pushfit Fittings	Angled	Drain-off tailpiece
VTL120-08S	Traditional TRV + Lockshield	8mm	Straight	
VTL120-10S	Traditional TRV + Lockshield	10mm	Straight	
VTL120-15S	Traditional TRV + Lockshield	15mm	Straight	
VTL120-15S-D	Traditional TRV + Lockshield	15mm	Straight	Drain-off tailpiece
VTL120-15S-P	Traditional TRV + Lockshield	10mm Pushfit Fittings	Straight	
VTL120-15S-DP	Traditional TRV + Lockshield	10mm Pushfit Fittings	Straight	Drain-off tailpiece

### Traditional TRV - Matching Manual Valve

Dimension, part numbers and descriptions

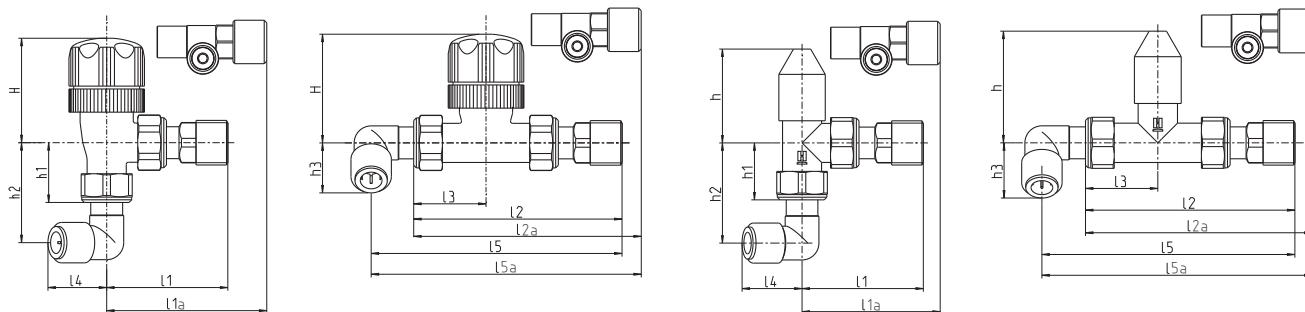

Part Number	H	h	h1	h2	h3	l1	l1a	l2	l2a	l3	l4	l5	l5a
VHL120-08A	52	45	32			58							
VHL120-10A	52	45	32			58							
VHL120-15A	52	45	32			58							
VHL120-15A-D	52	45	32				69						
VHL120-15A-P	52	45	32	48		58					28		
VHL120-15A-DP	52	45	32	48			69				28		
VHL120-08S	52	52						103		39			
VHL120-10S	52	52						103		39			
VHL120-15S	52	52						103		39			
VHL120-15S-D	52	52							116	39			
VHL120-15S-P	52	52			28			103		39			
VHL120-15S-DP	52	52			28				116	39			131

Part Number	Type	Size	Pattern	Ancillary Parts
VHL120-08A	Matching Manual Valve	8mm	Angled	
VHL120-10A	Matching Manual Valve	10mm	Angled	
VHL120-15A	Matching Manual Valve	15mm	Angled	
VHL120-15A-D	Matching Manual Valve	15mm	Angled	Drain-off tailpiece
VHL120-15A-P	Matching Manual Valve	10mm Pushfit Fittings	Angled	
VHL120-15A-DP	Matching Manual Valve	10mm Pushfit Fittings	Angled	Drain-off tailpiece
VHL120-08S	Matching Manual Valve	8mm	Straight	
VHL120-10S	Matching Manual Valve	10mm	Straight	
VHL120-15S	Matching Manual Valve	15mm	Straight	
VHL120-15S-D	Matching Manual Valve	15mm	Straight	Drain-off tailpiece
VHL120-15S-P	Matching Manual Valve	10mm Pushfit Fittings	Straight	
VHL120-15S-DP	Matching Manual Valve	10mm Pushfit Fittings	Straight	Drain-off tailpiece

### Radiator Balancing

**1.**

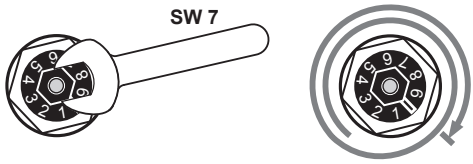

Valves are supplied in the 'fully open' position. To start the Balancing setting, turn the insert dial clockwise until fully closed (7mm wrench required)

Note : Do not over tighten or damage may result

**2.**

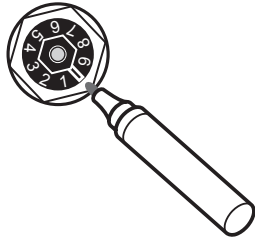

Mark the start position on the brass insert

**3.**



Check the required setting using the chart below and turn the insert dial anti-clockwise until fully the number matches the mark on the insert.

Example 1 = setting 4  
Example 2 = setting 14 (fully open)

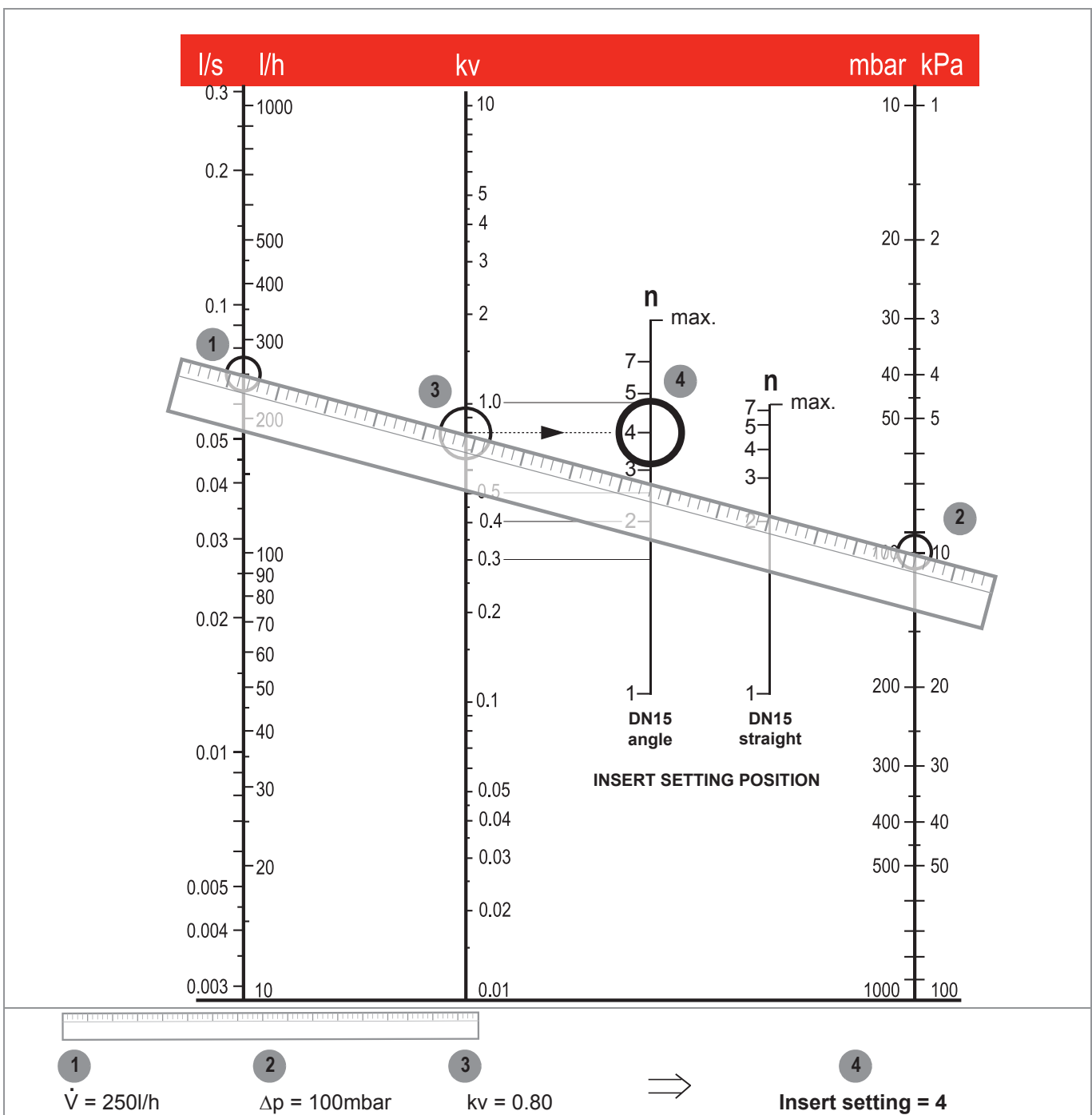

### Flow Diagram DN15 Straight

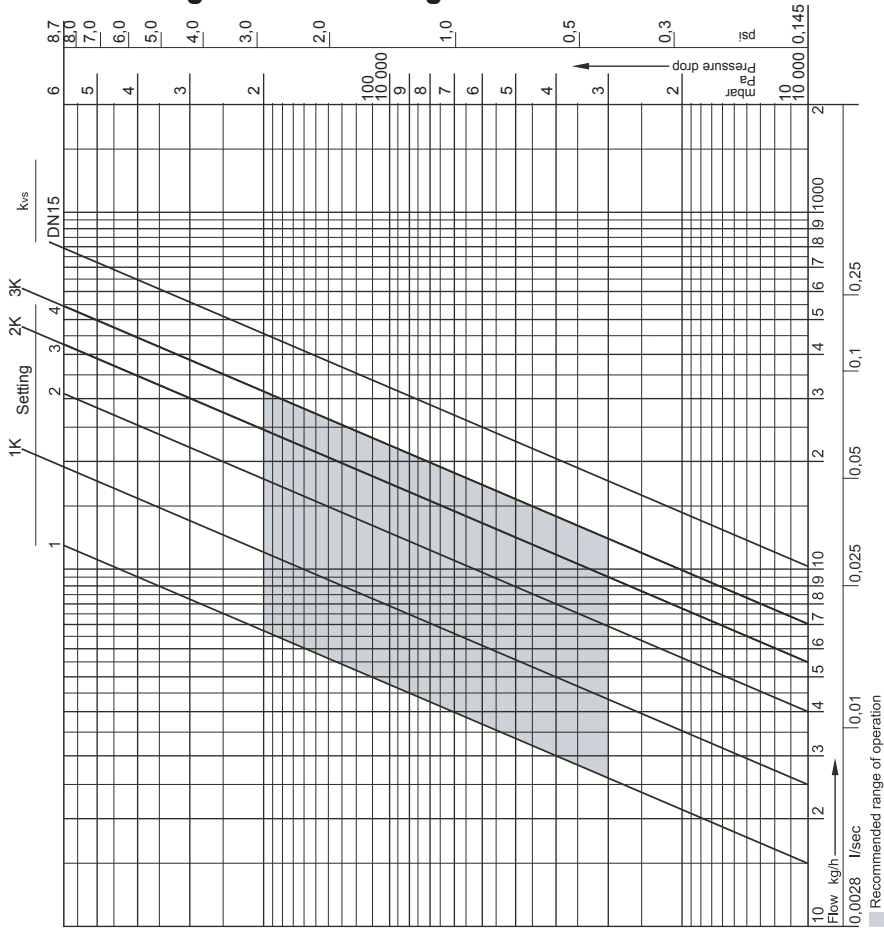

Balancing setting	1	2	3	4	5	7	14= open = kvs
<b>k<sub>v</sub>-value</b>	0.15	0.40	0.55	0.70	0.85	0.95	1.00
<b>c<sub>v</sub>-value</b>	0.18	0.47	0.64	0.82	0.99	1.11	1.17

P-Band	1K	2K	3K
<b>k<sub>v</sub>-value</b>	0.25	0.55	0.70
<b>c<sub>v</sub>-value</b>	0.29	0.64	0.82

### Tolerances for Balancing Setting Values

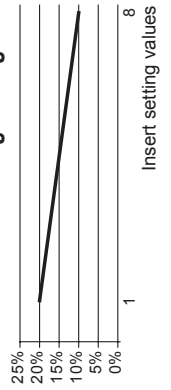

### Flow Diagram DN15 Angle

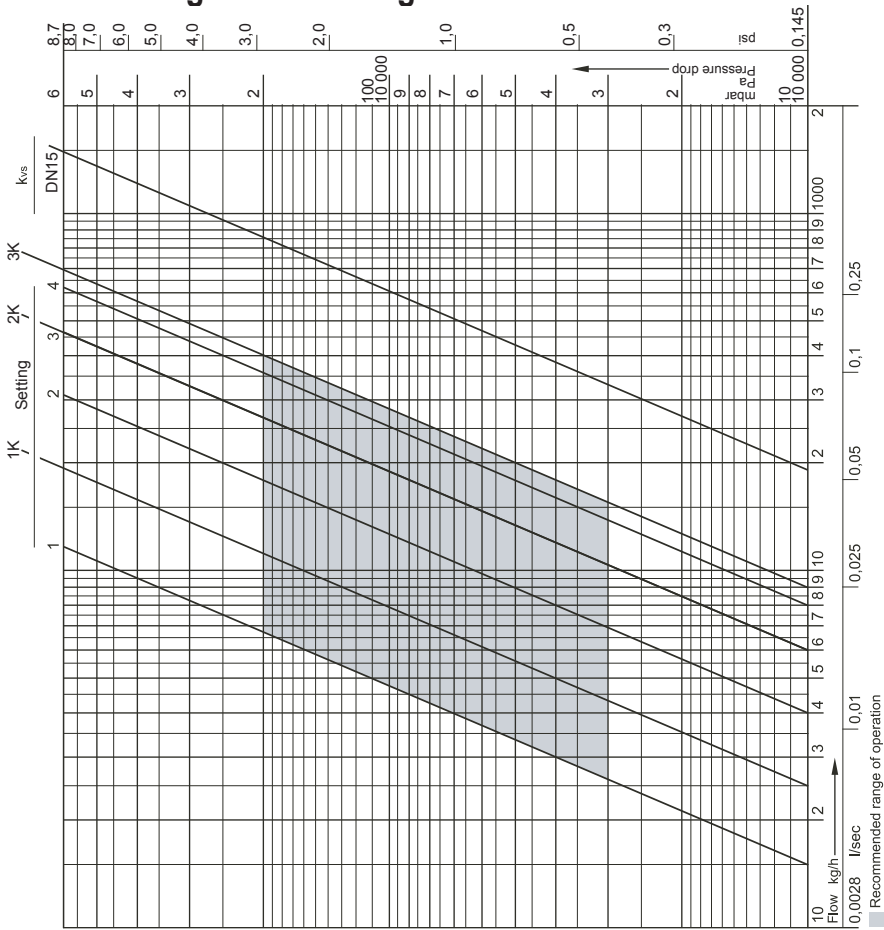







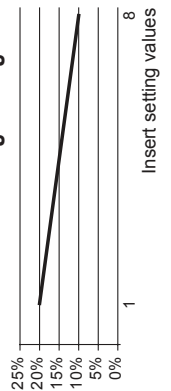



Balancing setting	1	2	3	4	5	7	14= open = kvs
<b>k<sub>v</sub>-value</b>	0.15	0.40	0.60	0.80	1.10	1.40	1.90
<b>c<sub>v</sub>-value</b>	0.18	0.47	0.70	0.93	1.28	1.63	2.22

P-Band	1K	2K	3K
<b>k<sub>v</sub>-value</b>	0.25	0.60	0.90
<b>c<sub>v</sub>-value</b>	0.29	0.70	1.05

### Tolerances for Balancing Setting Values

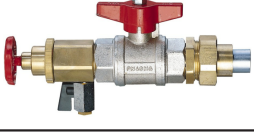

## Accessories

	Part Number	Description
	<b>T1001W0GB</b>	White Traditional TRV upgrade head. May be used to upgrade 'old' TRV heads or used on any VHL120 'Manual' TRV bodies to convert them to a TRV.
	<b>T4021GB</b>	Classic White / Chrome TRV upgrade head. May be used to upgrade 'old' TRV heads or used on any VHL120 'Manual' TRV bodies to convert them to a TRV
	<b>T4221GB</b>	Classic Polished Chrome TRV upgrade head. May be used to upgrade 'old' TRV heads or used on any VHL120 'Manual' TRV bodies to convert them to a TRV
	<b>T4321GB</b>	Classic Black / Chrome TRV upgrade head. May be used to upgrade 'old' TRV heads or used on any VHL120 'Manual' TRV bodies to convert them to a TRV
	<b>T4111GB</b>	Classic Brushed Chrome TRV upgrade head. May be used to upgrade 'old' TRV heads or used on any VHL120 'Manual' TRV bodies to convert them to a TRV
	<b>HR92UK</b>	White Evohome Electronic TRV upgrade head. May be used to upgrade 'old' TRV heads or used on any VHL120 'Manual' TRV bodies to convert them to an electronic TRV
	<b>V120-15A</b>	Valencia 15mm Angled TRV replacement body only (x 1)
	<b>VA8200A001</b>	Service tool to clean or replace TRV inserts, without the need to drain down the heating system (x 1)
	<b>VS1200SLGB11</b>	Replacement valve (SLGB) integrated balancing insert (x 1)
	<b>H100-1/2A</b>	Pack of 10x Manual Handwheels
	<b>TA6900A001</b>	White Theft Protection Ring (x 1)

## Honeywell Control Systems Ltd

Honeywell House  
Skimped Hill Lane  
Bracknell  
Berkshire  
RG12 1EB  
www.honeywelluk.com

EN0H-0000GE25 R0814  
August 2014  
© 2014 Honeywell International Inc.  
Subject to change • All rights reserved  
Manufactured for and on behalf of the Environmental and Combustion  
Controls Division of Honeywell Technologies Sàrl, Ecublens, Route  
du Bois 37, Switzerland or its authorized representative.

