

# Domestic Product Selection Guide



# Contact Details

## Danfoss Randall Limited



Danfoss Randall's UK based sales and manufacturing site

### Danfoss Randall Limited, Amptill Road, Bedford, MK42 9ER

#### **Reception**

Tel: 0845 1217 400  
Fax: 0845 1217 515

#### **UK Sales**

Tel: 0845 1217 500  
Fax: 0845 1217 510

#### **Devi Sales**

Tel: 0845 434 9990  
Fax: 0845 1217 510

#### **Customer Service**

Tel: 0845 1217 502

#### **Training**

Tel: 0845 1217 431  
Fax: 0845 1217 513

#### **Literature**

Tel: 0845 1217 431  
Fax: 0845 1217 513

#### **Technical Support**

Tel: 0845 1217 505  
Fax: 0845 1217 510

#### **Republic of Ireland Reception**

Tel: 1800 930 242

#### **Sales**

Tel: 1800 930 243  
Fax: 1800 556 691

#### **Technical Support**

Tel: 1800 930 244



Efficient lean production facility



State of the art, temperature controlled auto assembly cell



On-site product testing laboratory used internally and externally for product validation and research

# Domestic Product Selection Guide

## Contents

### Thermostatic Radiator Valves..... 6-19

RAS-C <sup>2</sup> Domestic Radiator Thermostats.....	8	RLV-D Domestic Lockshield Valves.....	14
RAS-D <sup>2</sup> Domestic Radiator Thermostats .....	9	RLV Commercial Lockshield Valves .....	15
RA2000 Commercial Radiator Thermostat .....	10	H-Pieces and Sensors for Built-In Valves .....	16
RA2000 Combi Packs.....	11	RA-URX, RA-RTX and VHS-UN Bathroom Solutions .....	17
RA-FN and RA-G Valve Bodies Without Pre-Setting .....	12	Replacement Sensors, Gland Seals and Accessories .....	18
RA-N Valve Bodies With Pre-Setting .....	13	Compression Fittings for Copper, PEX and ALUPEX .....	19

### Time Controls ..... 20-27

FP715Si, CP715Si, TS715Si Time Controls with Service Interval .....	22	SET1E, SET2E, SET3E and SET3M Time Controls .....	25
FP975 Replacement Time Controls.....	23	3020P, 3060 and 4033 MK3 Programmers.....	26
102, 102E7, 103, 103E7 GP Timeswitches and Mini-Programmers.....	24	811, 851, 852, 841, 842 - Commercial Time and Bell-Ringing Controls.....	27

### Electric Thermostats..... 28-47

TP4000 24 Hour Programmable Room Thermostat.....	30	RET-B Battery Powered Room Thermostat with Setting Dial.....	39
TP5000Si 24 Hour or 5/2 Day Programmable Room Thermostat .....	31	RET-M and RET-MD Room Thermostats with Delay Start.....	40
TP7000 7 Day or 5/2 Day Programmable Room Thermostat.....	32	RET230 Room Thermostats with Function Switches .....	41
TP9000 Programmable Room Thermostat With Hot Water .....	33	FlatStat Flush Mounted Room Thermostat .....	42
RT51 Digital Thermostat .....	34	RET230HC and RET230HCW Heat/Cool Room Thermostats.....	43
Radio Frequency Heating Controls.....	35	ORT Modulating Thermostats for OpenTherm Boilers.....	44
WP75-RF Hot Water Programmable Thermostat .....	36	Cylinder, Pipe and Frost Thermostats.....	45
6000 Series Heat/Cool Programmable Thermostats.....	37	ITC, ITL and ITD Immersion Thermostats .....	46
RMT and RET Room Thermostats with Setting Dial .....	38	Load Compensator Control Technology (Chrono-proportional) .....	47

### Underfloor Heating and Underfloor Warming ..... 48-57

DeviMat Electric Underfloor Warming.....	50	FH-BU Wireless Zone Control.....	55
DeviDry Electric Underfloor Warming .....	52	FHF-F Floor Heating Manifold.....	56
CF2 2-Way Wireless Floor Heating Control System .....	53	FHV-R Underfloor Heating Valve.....	57
FH-WC Hard Wired Zone Control.....	54		

### Motorised Zone Valves and Other Controls ..... 58-68

Hard Wired Control Packs and Wiring Centres.....	60	RAV, VMT, KOVM and VMV Small Seated Valves.....	65
Wireless Control Packs.....	61	TWA and ABV Thermal Actuators .....	66
H-Series Motorised Valves - Paddle Type .....	62	RAVI Thermostatic Cylinder Controls .....	67
H-Series Motorised Valves - Shoe Type.....	63	AVPL Differential Pressure Controls .....	68
AVDO Domestic Automatic Bypass Valves .....	64		

### Additional Information ..... 69-87

Wallplate Identification and Compatibility.....	70	Hard Wired Underfloor Heating System .....	82
Wiring Diagrams.....	71-76	Wireless Underfloor Heating System .....	83
Combi Boiler System.....	77	Radiator Thermostat Selection and Cross Reference Chart .....	84
Mid-Position Valve System.....	78	Commercial Radiator Thermostat Selection Guide.....	85
Two Port Zone Valve System .....	79	Literature Service - Order Form.....	86
Two Port Zone Valve System with Additional Heating .....	80	Warranty and Returns.....	87
Radio Frequency Control Packs and Wiring.....	81		





# Website

## www.danfoss-randall.co.uk

- Product search
- Product specifications
- Online literature search
- Wiring diagrams
- Online stockist search
- Frequent asked questions
- News and newsletters
- Training
- Literature Ordering
- Contact Information
- Exhibition Information

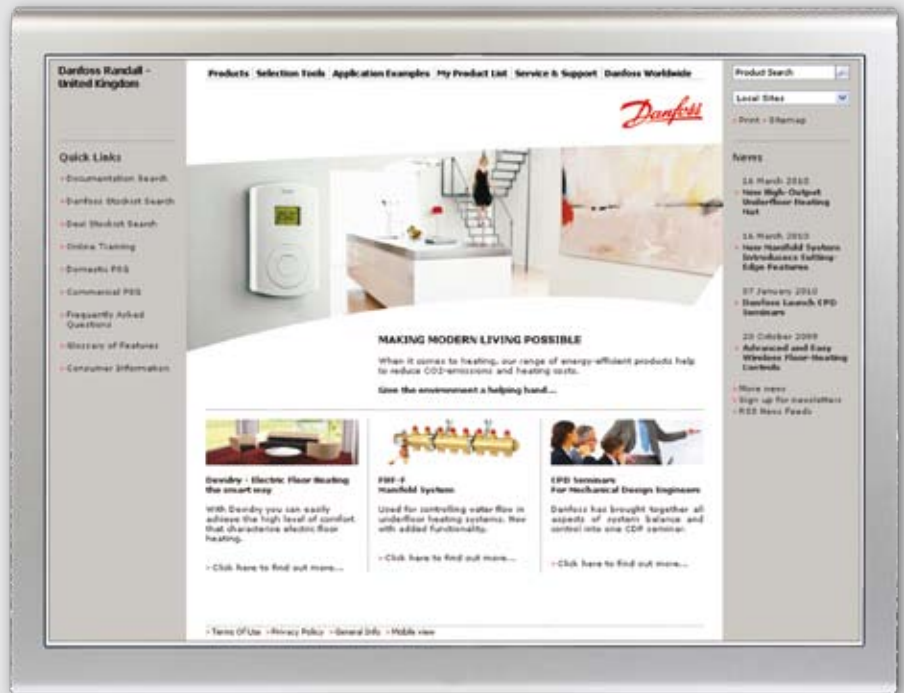

Today's high demand for energy-saving controls, plus the continual introduction of new products, has left many installers searching for answers. Optimum energy-efficiency in buildings increasingly calls for the use of advanced, more-effective controls. Some installers remain unaware of the latest, ground-breaking products that are essential to their continued professional success.

A great starting place for this information is **www.danfoss-randall.co.uk**. After many months of research, dedicated work, structured thought, imagination and unwavering attention to detail an easily navigable on-line encyclopaedia of clear and easily accessible information on controls for domestic, commercial and industrial heating/cooling applications is available. Visitors to the site will also find valuable advice, tips and detailed connection diagrams.

Navigation of the website is extremely quick and easy, and is helped by its cool, uncluttered style. With just a few clicks, product listings, selection tables and illustrations appear on screen instantly. Favourite products can be conveniently saved as a list for future visits.

Datasheets, instructions and user guides may be downloaded in pdf format and printed. Clear wiring connection diagrams for all popular controls are provided.

The 'Understanding Heating Controls' advice section explains controls usage and explodes many of the myths that have grown up surrounding domestic heating controls. This section can be easily downloaded and printed.

Full contact details are given to enable site visitors to obtain Sales Office support, order literature, obtain details of Training Seminars and pose specific controls problems to a Danfoss expert.





# 77 years

of innovation

Constantly innovating since 1933, Danfoss is a name you can trust to bring you the best in modern controls technology.

# Radiator Thermostats Product Selector

<b>Domestic TRV's and Lockshield Valves</b> <i>(for use on 2-pipe systems only)</i>					
<b>Combi Packs</b>	<b>Radiator Packs</b>	<b>Lockshield Valves</b>	<b>Accessories</b>	<b>Towel Rail Valves</b>	<b>Page</b>
<i>Valve &amp; Sensor</i>	<i>Valve, Sensor &amp; Lockshield</i>				
RAS-C <sup>2</sup>	RAS-C <sup>2</sup>				<b>8</b>
RAS-D <sup>2</sup>	RAS-D <sup>2</sup>				<b>9</b>
		RLV-D			<b>14</b>
			Pipe Fittings		<b>19</b>
			Drain-off Tailpiece		<b>8, 9</b>
				RA-URX	<b>17</b>
				RA-RTX	<b>17</b>

<b>Commercial TRV's and Lockshield Valves - Valve Bodies</b>				
<b>1-pipe systems</b>	<b>2-pipe systems</b>			<b>Page</b>
<i>Without Pre-setting</i>	<i>Without Pre-setting</i>	<i>With Pre-setting</i>	<i>Lockshield Valves</i>	
RA-G	RA-FN			<b>12</b>
		RA-N		<b>13</b>
			RLV*	<b>15</b>
			RLV-S	<b>15</b>

\* RLV has drain-off facility

<b>Commercial TRV's - Sensors</b>					
<b>Built-in</b>	<b>Remote</b>	<b>Wall Adjusters</b>	<b>Combi Packs</b>	<b>Replacement</b>	<b>Page</b>
RA2000	RA2000	RA2000			<b>10</b>
			RA2000		<b>11</b>
				RA/V	<b>18</b>
				RA/VL	<b>18</b>

<b>Commercial TRV's</b> <i>Towel Rail Valves, H-pieces, Spares, Accessories and Compression Fittings</i>					
<b>Towel Rail Valves</b>	<b>H-Pieces</b>	<b>Spares</b>	<b>Accessories</b>	<b>Pipe Fittings</b>	<b>Page</b>
VHS					<b>17</b>
	RLV-KD				<b>16</b>
		For RA2000 Valves & Sensors			<b>18</b>
				Copper	<b>19</b>
				PEX	<b>19</b>
				ALUPEX	<b>19</b>

# Thermostatic Radiator Valves

## *Accurate, Reliable, Energy Saving Controls*

<i>RAS-C<sup>2</sup></i> .....8	<i>RLV-D</i> ..... 14
Domestic Radiator Thermostat	Domestic Lockshield Valves
<i>RAS-D<sup>2</sup></i> ..... 9	<i>RLV</i> ..... 15
Domestic Radiator Thermostat	Commercial Lockshield Valves
<i>RA2000</i> ..... 10	<i>H-Pieces and Sensors</i> ..... 16
Commercial Radiator Thermostat	For Built-In Valves
<i>RA2000</i> ..... 11	<i>RA-URX, RA-RTX and VHS-UN</i> ..... 17
Combi Packs	Bathroom Solutions
<i>RA-FN and RA-G</i> ..... 12	<i>Accessories</i> ..... 18
Valve Bodies Without Pre-Setting	Replacement Sensors, Gland Seals and Accessories
<i>RA-N</i> ..... 13	<i>Compression Fittings</i> ..... 19
Valve Bodies With Pre-Setting	For Copper, PEX and ALUPEX Pipe





# Domestic Radiator Thermostat RAS-C<sup>2</sup>

The compact RAS-C<sup>2</sup> is equally suited to both the domestic and contract market, and comes complete with the revolutionary 'flow selectable' revolver valve body.

The stylish RAS-C<sup>2</sup> sensor is packaged together with the innovative flow selectable RA-FS bi-directional valve body which can be mounted either vertically or horizontally in flow or return. If water hammer is experienced a patented flow selection device within the valve can be turned to reverse the water direction inside the valve without the need to drain down the system. A quick and easy solution to an otherwise expensive problem.

The RAS-C<sup>2</sup> sensor, based upon the tried and tested liquid sensor actuator, is compact and provides highly accurate temperature control.

Sensor mounting requires no tools, simply press the sensor onto the valve body and hand tighten a clamping ring to secure.

The sensor incorporates a frost protection setting and a positive off feature, useful if radiators need to be removed for decoration.

RAS-C<sup>2</sup> sensors are compatible with RA-FS flow selectable bi-directional valves, RA-FN, RA-N and RA-G valve bodies.

Approved to European standard EN215 and manufactured under ISO9002 quality systems.

Please note: If the RA-FS valve is used with RA2000 sensors, the flow direction must be determined during commissioning and the flow selector set accordingly.

### Additional Information:

Lockshield Valves p.14  
Compression Fittings p.19



- With unique flow selectable bi-directional valve
- Stylish sensor, compact and easy to fit
- Available in convenient combi packs
- Radiator packs with matching lockshield valves also available
- Available in 8/10 and 15mm sizes, plus 10mm push-fit elbow version
- High performance liquid sensor

RAS-C <sup>2</sup> Bi-Directional TRV c/w built-in sensors Combi Packs (2-pipe systems)				
Code No	Description <sup>(4)</sup>			Temp. Range <sup>(1)</sup> °C (Xp=2k)
<b>Combi Pack: Sensor &amp; TRV Valve</b>				
013G605000	15mm Reversible Angle c/w Built-in Sensor			8-28 <sup>(2)</sup>
013G605500	8/10mm Reversible Angle c/w Built-in Sensor			
013G605100	15mm Straight c/w Built-in Sensor			
013G605600	8/10mm Straight c/w Built-in Sensor			
013G606000	15mm Reversible Angle with 10mm push-fit elbow c/w Built-in Sensor <sup>(3)</sup>			
<b>Radiator Pack: Sensor, TRV Valve &amp; Lockshield Valve</b>				
013G600500	15mm Reversible Angle TRV c/w Built-in Sensor & Matching Lockshield Valve			8-28 <sup>(2)</sup>
013G600600	8/10mm Reversible Angle TRV c/w Built-in Sensor & Matching Lockshield Valve			
013G600300	15mm Straight c/w Built-in Sensor			
013G600400	8/10mm Straight c/w Built-in Sensor			
013G600700	15mm Reversible Angle TRV c/w Built-in Sensor & Matching Lockshield Valve, both with 10mm push-fit elbows <sup>(3)</sup>			
<b>RAS-C<sup>2</sup> Thermostatic Sensor Only</b>				
013G604000	Built-in Sensor includes 'Positive Off'			8-28 <sup>(2)</sup>
<b>Angled Bi-Directional Valve Bodies c/w Fittings, Reversible for 2-Pipe Systems</b>				
Code No	Pattern	Connections		Kv Value (Xp=2k)
		Pipe	Radiator Tail	
013G628300	RA-FS Angle	8/10mm	1/2" BSP	0.55
013G628100	RA-FS Angle	15mm	1/2" BSP	0.55
<b>Accessories</b>				
013G491300	Collet Clip to Prevent Accidental De-mounting of Push-fit Fitting (10 Pieces)			
013G491200	Decorative Cover for Push-fit Fitting (10 Pieces)			
003L010500	Drain-off Tailpiece for Use with RLV-D Valve and RA-FS Valves			
<sup>(1)</sup> Temperature range may be reduced by 2°C by fitting displacer cap (013L123400).				
<sup>(2)</sup> Allowing for influence of flow temperature and radiation.				
<sup>(3)</sup> For use with PB and PEX plastic pipes complying with BS7291, including Hep <sub>2</sub> O, Osmagold, Polyplumb and Equator - correct insert must be used.				
<sup>(4)</sup> All valves have 1/2" connection to radiator.				

# Domestic Radiator Thermostat RAS-D<sup>2</sup>



RAS-D<sup>2</sup> Chrome Angled



RAS-D<sup>2</sup> White/Chrome Straight



RAS-D<sup>2</sup> Radiator Pack

The RAS-D<sup>2</sup> range complements the one-off market with its modern, stylish design and comes complete with the revolutionary 'flow selectable' revolver valve body.

The RAS-D<sup>2</sup> radiator thermostats are designed for use in 2-pipe domestic heating systems like designer radiators or towel rails. All RAS-D<sup>2</sup> Combi Packs comprise of a RA-FS bi-directional valve and a RAS-D<sup>2</sup> sensor. Combi packs are also available with a RLV-D lockshield valve. The valves have a 1/2" BSP (R1/2") tail piece connection to the radiator and include 8mm, 10mm and 15mm compression fittings to connect the valve to the pipe work.

The valve bodies are reversible and bi-directional and include a flow-selectable feature to ensure trouble free installation without any risk of water hammer.

The valve is supplied with a protective cap, which can be used for manual regulation during the construction phase. The cap must not be used as a manual shut off device. RAS-D<sup>2</sup> sensors incorporate a "Frost Protection" setting and a "Positive Off" feature for maximum user flexibility. Temperature range is from 8°C to 28°C.

All Danfoss RAS-D<sup>2</sup> sensors and RA-FS valves are manufactured to the highest standards. All Danfoss radiator thermostats and valves are manufactured in factories, assessed and certified by BSI against ISO 9001 / BS 5750.

Valve bodies are manufactured from brass with chrome plating. The spindle in the gland seal is made of chromium steel and works in a lifetime lubricated O-ring. The complete gland assembly can be replaced without draining down the system.

### Additional Information:

Lockshield Valves p.14  
Compression Fittings p.19

- Unique flow selectable bi-directional valve
- High performance liquid sensor
- Convenient combi packs
- Radiator packs available with matching lockshield valves
- Reversible bi-directional angled pattern valve bodies
- Available in subtle white with chrome styling sensor or a stunning all chrome model to compliment designer radiators and towel rails

RAS-D <sup>2</sup> Bi-Directional TRV c/w built-in sensors Combi Packs (2-Pipe systems)				
Code No	Description <sup>(3)</sup>	Temp Range <sup>(1)</sup> °C (Xp=2k)		
<b>Combi Pack: Sensor &amp; TRV Valve</b>				
013G601300	8/10/15mm Reversible Angle, Chrome/White, Built-in Sensor	8-28 <sup>(2)</sup>		
013G601200	8/10/15mm Reversible Angle, All Chrome, Built-in Sensor			
013G601500	8/10/15mm Reversible Straight Chrome/White			
013G601400	8/10/15mm Reversible Straight All Chrome Built-in Sensor			
<b>Radiator Pack: Sensor, TRV Valve &amp; Lockshield Combinations</b>				
013G601700	8/10/15mm angle, white/chrome sensor and chrome valve body. Flow selectable reversible bi-directional. Includes compression connections	8-28 <sup>(2)</sup>		
013G601600	8/10/15mm angle, All chrome sensor and chrome valve body. Flow selectable reversible bi-directional. Includes compression connections.			
013G601900	8/10/15mm straight, white/chrome sensor and chrome valve body. Flow selectable reversible bi-directional. Includes compression connections.			
013G601800	8/10/15mm straight, All chrome sensor and chrome valve body. Flow selectable reversible bi-directional. Includes compression connections.			
<b>RAS-D<sup>2</sup> Thermostatic Sensor Only</b>				
013G617600	Fixed Sensor, white/chrome	8-28 <sup>(2)</sup>		
013G617000	Fixed Sensor, All chrome	8-28 <sup>(2)</sup>		
<b>Angled Bi-Directional Chrome Valve Body c/w Fittings, Reversible for 2-Pipe Systems</b>				
Code No	Pattern	Connections		Kv Value (Xp=2k)
		Pipe	Radiator Tail	
013G628200	RA-FS Angle	8/10/15mm	1/2" BSP	0.55
<b>Straight Bi-Directional Chrome Valve Body Complete with Fittings (2-Pipe Systems)</b>				
013G628400	RA-FS Straight	8/10/15mm	1/2" BSP	0.55
<b>Accessories</b>				
003L009900	Drain-off Tailpiece for use with RLV-D Valve and RA-FS Valves, chrome			
Notes:				
(1) Temperature range may be reduced by 2°C by fitting displacer cap (013L123400).				
(2) Allowing for influence of flow temperature and radiation.				
(3) All valves have 1/2" connection to radiator.				

# Commercial Radiator Thermostat RA2000

**For the commercial market, Danfoss offers a range of valves and sensors, suitable for practically all types of systems and installation conditions.**

Sensors and valve bodies, which are packed separately, can be mixed and matched by the specifier and installer to meet the specific needs of each and every installation.

RA2000 sensors are robustly constructed to withstand the misuse and abuse often found in the commercial and industrial sectors.

The range includes high strength, tamperproof models, ideal for use in public buildings, including schools.

All models offer locking and limiting as standard. RAS-D<sup>2</sup> may also be used for light commercial applications.

RA2000 sensors are compatible with RA-FS, RA-FN, RA-N and RA-G valve bodies.

Approved to European Standard EN215, and manufactured under ISO9002 Quality Systems.

Please note: If using RA2000 sensors with RA-FS Bi-directional valve bodies, valve flow selector must be commissioned.

A separate catalogue covering the full range of RA2000 radiator thermostats is available on request.

### Additional Information:

TRV Valve Bodies p.12

Lockshield Valves p.15

Locking and Limiting Tool p.18



RA2912 Remote Sensor

RA2910 and RA2920 Sensor



RA5062 Remote Adjuster

- **Superb performance**
- **Robust construction**
- **Fits RA-FS, RA-FN, RA-N and RA-G valve bodies**
- **Special tamperproof versions available**

RA2000 Built-in Sensors					
Code No	Type	Old Code No	Type	Description	Temp Range <sup>(1)</sup> °C (Xp=2k)
013G291000	RA2910	013G201000	RA2010	Includes Locking and Limiting	5-26 <sup>(2)</sup>
013G292000	RA2920	013G202000	RA2020	Tamperproof Model Includes Locking and Limiting <sup>(3)</sup>	5-26 <sup>(2)</sup>
013G291400	RA2914	013G207000	RA2070	Low Temperature Range Model Includes Locking and Limiting	5-22 <sup>(2)</sup>
RA2000 Remote Sensors (0-2m capillary) <sup>(3)</sup>					
013G291200	RA2912	013G201200	RA2012	Includes Locking and Limiting	5-26
013G292200	RA2922	013G202200	RA2022	Tamperproof Model Includes Locking & Limiting <sup>(3)</sup>	5-26
013G291600	RA2916	013G207200	RA2072	Low Temperature Range Model Includes Locking and Limiting	5-22
RA2000 Remote Temperature Adjusters <sup>(4)</sup>					
013G506200	RA5062	2m Capillary includes Locking and Limiting			6-28
013G506500	RA5065	5m Capillary includes Locking and Limiting			6-28
013G506800	RA5068	8m Capillary includes Locking and Limiting			6-28
Remote Temperature Adjuster with Remote Sensor					
013G546600	FEV-FF	2 x 2m Capillary Includes Locking and Limiting			17-27

<sup>(1)</sup> Temperature range may be reduced by 2°C by fitting displacer cap (013L123400)  
<sup>(2)</sup> Allowing for influence of temperature and radiation  
<sup>(3)</sup> Remote sensor capillary coiled inside sensor housing, extend as required on installation  
<sup>(4)</sup> Remote sensor capillary coiled inside temperature adjuster housing, extend as required on installation



# Combi and Radiator Packs RA2000

Complementing the range of individual separates available in the RA2000 range are the RA2000 Combi and Radiator Packs.

The range of four packs brings together the most popular RA2000 components into a convenient package allowing for simple ordering of all components with one code number.

Packs come complete with a standard RA2910 thermostatic head and are available in either 1/2" (complete with 15mm compression adaptors) or 3/4" variations and with or without a lockshield valve.



RA-FN Vertical

RA2910

RLV 15 Vertical

- Convenient pack based solution
- Packs available with or without lockshield
- 4 unique valve combinations covering the most popular RA2000 combinations

Description	Contains	Code No
Vertical Angle 1/2" / 15mm Combi pack	1 x RA2910 Thermostatic Head 1 x RA-FN15 Valve (inc 15mm compression fitting)	013G602100
Vertical Angle 3/4" Combi Pack	1 x RA2910 Thermostatic Head 1 x RA-FN20 Valve	013G602200
Vertical Angle + Lockshield Valve 1/2" / 15mm Radiator Pack	1 x RA2910 Thermostatic Head 1 x RA-FN15 Valve (inc 15mm compression fitting) 1 x RLV-S15 1/2"/15mm Lockshield	013G602300
Vertical Angle + Lockshield Valve 3/4" Radiator Pack	1 x RA2910 Thermostatic Head 1 x RA-FN20 Valve 1 x RLV-S20 3/4" Lockshield	013G602400

# Valve Bodies Without Pre-Setting

## RA-FN and RA-G

The choice and variety of radiator thermostat valve bodies available from Danfoss allows the specifier and installer to choose the right valve for the job.

### RA-G - for 1-pipe systems

For use in conventional 1-pipe systems, where circulation through the radiator relies on gravity. RA-G valves have capacities optimised for this type of system which requires high flow rates at low pressure drops to function correctly.

Available in straight and angled pattern versions in 1/2", 3/4" and 1" sizes, RA-G valves can be used with the whole range of RA2000 sensors.

RAS-C<sup>2</sup> and RAS-D<sup>2</sup> sensors are not recommended as these reduce the valve capacity.

### RA-FN - for 2-pipe systems, without presetting

For use in commercial 2-pipe systems using steel pipe. RA-FN valves are available in 3/8", 1/2", 3/4" and 1" sizes in angled and straight pattern versions. RA-FN valves can be used with all RA2000, RAS-D<sup>2</sup> and RAS-C<sup>2</sup> sensors, although valve capacity is reduced if RAS-C<sup>2</sup> or RAS-D<sup>2</sup> sensors are used.

If pre-setting is required, RA-N valves should be specified, otherwise radiators must be balanced using conventional lockshield valves.

A full range of compression fittings for copper and plastic pipe are available for use with RA-FN valves, see page 19 for details.

### Additional Information:

RA2000 Sensors p.10  
Compression Fittings p.19



- Wide range of sizes from 3/8" to 1"
- Valves available in straight, vertical angle and horizontal angle patterns
- Valves available for 2-pipe and 1-pipe systems
- Compatible with all RA2000, RAS-C<sup>2</sup> and RAS-D<sup>2</sup> sensors

RA-FN Valve Bodies for 2-Pipe Systems, without Pre-Setting					
Pattern	Type	Code No	Connections		Kv Value Xp = 2k <sup>(2)</sup>
			Pipe	Radiator Tail	
Straight	RA-FN 10	013G002200	3/8" BSP	3/8" BSP	0.56
	RA-FN 15	013G002400	1/2" BSP	1/2" BSP	0.73
	RA-FN 15	013G008400	15mm or 1/2" BSP	1/2" BSP	0.73
	RA-FN 20	013G002600	3/4" BSP	3/4" BSP	1.04
	RA-FN 25	013G002800	1" BSP	1" BSP	1.04
Vertical Angle <sup>(1)</sup>	RA-FN 10	013G002100	3/8" BSP	3/8" BSP	0.56
	RA-FN 15	013G002300	1/2" BSP	1/2" BSP	0.73
	RA-FN 15	013G0023AA	15mm or 1/2" BSP	1/2" BSP	0.73
	RA-FN 20	013G002500	3/4" BSP	3/4" BSP	1.04
	RA-FN 25	013G002700	1" BSP	1" BSP	1.04
Horizontal Angle	RA-FN 10 UK	013G014100	3/8" BSP	3/8" BSP	0.56
	RA-FN 15 UK	013G014900	15mm or 1/2" BSP	1/2" BSP	0.73
	RA-FN 20 UK	013G014500	3/4" BSP	3/4" BSP	0.80
RA-G Valve Bodies for 1-Pipe Systems <sup>(3)</sup>					
Straight	RA-G 15	013G338400	1/2" BSP	1/2" BSP	1.42
	RA-G 20	013G338600	3/4" BSP	3/4" BSP	2.06
	RA-G 25	013G338800	1" BSP	1" BSP	2.69
Vertical Angle <sup>(1)</sup>	RA-G 15	013G338300	1/2" BSP	1/2" BSP	1.42
	RA-G 20	013G338500	3/4" BSP	3/4" BSP	2.06
	RA-G 25	013G338700	1" BSP	1" BSP	2.69
(1) For optimum performance we recommend the use of a remote sensor.					
(2) Kv values when used with RA2000 sensors.					
(3) Not suitable for use with fittings listed on page 19.					
Technical Specifications					
Max. Operating Temperature	120°C	Max. Diff. Pressure (RA-FN)		0.6 Bar	
Max. Working Pressure	10 Bar	Max. Diff. Pressure (RA-G 25)		0.16 Bar	
		Max. Diff. Pressure (RA-G 15 & 20)		0.2 Bar	

# Valve Bodies With Pre-Setting RA-N



RA-N Straight



RA-N Calibrated Setting Scale



RA-N Range

- Provides accurate flow regulation in 2-pipe systems
- Range of valve body sizes available
- Easy to set adjustment, does not affect valve lift
- Concealed setting, prevents unauthorised adjustment
- Compatible with all RA2000 RAS-C<sup>2</sup> and RAS-D<sup>2</sup> sensors

RA-N radiator thermostat valve bodies are designed to assist balancing in large heating systems.

For use in commercial 2-pipe systems. RA-N valves are available in 3/8", 1/2" and 3/4" sizes in angled and straight pattern versions. RA-N valves can be used with all RA2000, RAS-D<sup>2</sup> and RAS-C<sup>2</sup> sensors, although valve capacity is reduced if RAS-C<sup>2</sup> or RAS-D<sup>2</sup> sensors are used.

Valves with pre-setting allow the commissioning engineer to precisely set the calculated flow of water to individual radiators without the need for costly and inaccurate temperature measurements. They also reduce the function of the lockshield valve to one of isolation rather than regulation.

In the Danfoss range, pre-setting is achieved by means of a separate pre-setting device integrated into the valve body, and does not interfere in any way with the degree of opening of the valve cone, as seen with other pre-setting systems.

Pre-setting is achieved by means of a calibrated setting ring on the valve body, which is covered once the radiator thermostat is mounted.

A full range of compression fittings for copper and plastic pipe are available, see page 19 for details.

### Additional Information:

RA2000 Sensors p.10  
Compression Fittings p.19

RA-N Valve Bodies for 2-Pipe Systems, with Pre-Setting						
Pattern	Type	Code No	Connections		Kv Value	
			Pipe	Radiator Tail	Xp = 2k <sup>(1)&amp;(3)</sup>	
Straight	RA-N 10	013G003200	3/8" BSP	3/8" BSP	0.04	0.56
	RA-N 15	013G003400	1/2" BSP	1/2" BSP	0.04	0.73
	RA-N 15	013G0034AA	15mm or 1/2" BSP	1/2" BSP	0.04	0.73
	RA-N 20	013G003600	3/4" BSP	3/4" BSP	0.10	1.04
	RA-N 25	013G003800	1" BSP	1" BSP	0.10	1.04
Vertical Angle <sup>(2)</sup>	RA-N 10	013G003100	3/8" BSP	3/8" BSP	0.04	0.56
	RA-N 15	013G003300	1/2" BSP	1/2" BSP	0.04	0.73
	RA-N 15	013G0033AA	15mm or 1/2" BSP	1/2" BSP	0.04	0.73
	RA-N 20	013G003500	3/4" BSP	3/4" BSP	0.10	1.04
	RA-N 25	013G003700	1" BSP	1" BSP	0.10	1.04
Horizontal Angle	RA-N 10	013G015100	3/8" BSP	3/8" BSP	0.04	0.56
	RA-N 15	013G15300	1/2" BSP	1/2" BSP	0.04	0.73
	RA-N 15	013G0153AA	15mm or 1/2" BSP	1/2" BSP	0.04	0.73
	RA-N 20	013G015500	3/4" BSP	3/4" BSP	0.16	0.80
Side Angle <sup>(4)</sup>	RA-N 10R	013G023100	3/8" BSP	3/8" BSP	0.04	0.56
	RA-N 10L	013G023200	3/8" BSP	3/8" BSP	0.04	0.56
	RA-N 15R	013G023300	1/2" BSP	1/2" BSP	0.04	0.73
	RA-N 15L	013G023400	1/2" BSP	1/2" BSP	0.04	0.73

(1) Kv value at Xp=2 when used with RA2000 sensors

(2) For optimum performance we recommend the use of a remote sensor.

(3) Refer to setting table supplied with valves to adjust Kv

(4) L = Left, R = Right

### Technical Specifications

Max. Operating Temperature	120°C
Max. Working Pressure	10 Bar
Max. Differential Pressure	0.6 Bar



# Domestic Lockshield Valves RLV-D

The range of domestic lockshield valves are engineered to extremely high standards, and finished to match the range of radiator thermostat valve bodies.

The RLV-D range of domestic lockshield valves are identical in finish and dimensions to the RA-FS valve bodies used with the RAS-D<sup>2</sup> and RAS-C<sup>2</sup> radiator thermostat combi packs. All of the fittings, including the tailpieces, are fully interchangeable for total ease of installation.

Available in angled pattern 15mm and 8/10mm sizes with conventional compression fittings and in a version incorporating a 10mm push-fit elbow, the valves are ideal for new build, repairs and system upgrades.

Adjustment of the lockshield valve is by means of a 6mm Allen key. The setting cover is nickel-plated brass, which is screwed onto the valve body.

An accessory pack which converts the valve into a conventional wheelhead valve is also available.

The valves can be purchased separately or in easy to buy combi packs, which include a lockshield and wheelhead valve. Versions are also available with RAS-C<sup>2</sup> or RAS-D<sup>2</sup> sensors, please refer to pages 8 and 9 for further details.

### Additional information:

Compression fittings p.19



**Chrome Lockshield Straight and with Wheelhead**



**Nickel Lockshield and Chrome Wheelhead**



**Drain Off Tail Pieces**

- **Matching valve body, fully interchangeable with radiator thermostat valve bodies**
- **Available in 15mm and 8/10mm with compression fittings**
- **Available in 15mm version with 10mm push-fit elbow**
- **Available as separates or in convenient packs with radiator thermostats**

Code No	Domestic Lockshield Valves, Nickel Finish <sup>(1)</sup>
003L020300	15mm angled pattern lockshield valve with compression fitting
003L020400	8/10mm angled pattern lockshield valve with compression fitting
003L020500	15mm angled pattern lockshield valve with 10mm push-fit elbow <sup>(2)</sup>
Code No	Domestic Lockshield Valves, Chrome Finish <sup>(1)</sup>
003L021800	8/10/15mm straight lockshield valve with compression fitting
003L021900	8/10/15mm angled pattern lockshield valve with compression fitting
Code No	Matching Lockshield and Wheel Head, Nickel Finish <sup>(3)</sup>
003L023400	Angled 8/10mm
003L023500	Angled 15mm
003L023600	Straight 8/10mm
003L023700	Straight 15mm
Code No	Matching Lockshield and Wheel Head, Chrome Finish <sup>(3)</sup>
003L023800	Angled 8/10/15mm
003L023900	Straight 8/10/15mm
Code No	Accessories
013G491300	Collet clip to prevent accidental de-mounting of push-fit fitting (10 pieces)
013G491200	Decorative cover for push-fit fitting (10 pieces)
003L010500	Drain-off tailpiece for use with RA-FS and RLV-D valves, nickel
003L009900	Drain-off tailpiece for use with RA-FS and RLV-D valves, chrome
003L010600	RLV-D wheel head kit, colour soft white (can be used as lockshield valve cover)
003L010800	RLV-D cover cap in white (50 pieces)

Notes: (1) All valves have 1/2" connection to radiator.

(2) For use with PB and PEX plastic pipes complying with BS7291 including Hep<sub>2</sub>0, Osmagold, Polyplumb and Equator - correct insert must be used.

(3) For lockshield options with matching RAS-C<sup>2</sup> and RAS-D<sup>2</sup> please refer to pages 8 and 9

Specification	
Maximum Working Pressure	10 bar
Maximum Water Temperature	120°C
Finish	Chrome or Nickel Plated
Screw on Cover Cap	Plastic

# Commercial Lockshield Valves

## RLV



RLV Angled



RLV-S Straight



Drain-Cock Adaptor

- Robust construction
- Body finish matches all Danfoss radiator thermostat valve bodies
- Available in 3/8", 1/2" and 3/4" BSP sizes, and 15mm compression
- Available in straight or vertical angle patterns
- Unique drain-cock accessory available for use with RLV model

The RLV range of lockshield valves provides a matching return mounted lockshield/isolation valve for use in commercial heating systems.

The valve body design and finish matches all RA2000 series valve bodies, including RA-FN, RA-G and RA-N.

RLV lockshield valves combine the functions of isolation and regulation into a single valve body. Selected models are available with an integrated drain-cock connection that can be used together with a drain-cock accessory, which is purchased separately. Please refer to the ordering table for details.

Adjustment of the lockshield valve is by means of a 6mm Allen key. The setting cover is nickel-plated brass, which is screwed onto the valve body.

The drain-cock adaptor also provides a convenient way of re-filling a radiator or radiator circuit by means of a filling hose.

Available in straight or angled pattern in sizes 3/8", 1/2" and 3/4" BSP and 15mm compression.

Please note: A range of compression fittings, for use with copper, PEX and ALUPEX pipe, are available - see page 19 for details.

**Additional information:**  
Compression fittings p.19

RLV Commercial Lockshield Valves						
Pattern	With Drain-Cock Adaptor Connection		Without Drain-Cock Adaptor Connection		Connection Sizes	
	Type	Code No	Type	Code No	Pipe	Radiator
Vertical Angle	RLV 10	003L014100	RLV-S 10	003L012100	3/8"	3/8"
	RLV 15	003L014300	RLV-S 15	003L012300	1/2"	1/2"
	RLV 15	003L014315	RLV-S 15	003L012315	15mm	1/2"
	RLV 20	003L014500	RLV-S 20	003L012500	3/4"	3/4"
Straight	RLV 10	003L014200	RLV-S 10	003L012200	3/8"	3/8"
	RLV 15	003L014400	RLV-S 15	003L012400	1/2"	1/2"
	RLV 15	003L014415	RLV-S 15	003L012415	15mm	1/2"
	RLV 20	003L014600	RLV-S 20	003L012600	3/4"	3/4"
Drain-Cock Adaptor and Compression Fittings for RLV Series Valves						
Code No	Description					
003L015200	Drain-cock adaptor for use with RLV models only, not RLV-S					
Specification						
Maximum Working Pressure					10 Bar	
Maximum Working Temperature					120°C	
Test Pressure					16 Bar	
Valve Body Finish					Nickel Plated	
Gland Seal Type					Double O-ring	
Supplied with LSV Cap (nickel plated brass)					Yes	
Supplied with Wheel Head Cap					No	

# For Built-In Valves H-Pieces and Sensors

Special add-on components for valve radiators where the need for conventional radiator thermostat bodies and lockshield valve bodies has been eliminated.

### RLV-KS and RLV-KD H-pieces

H-pieces are used to interconnect system pipework in 2-pipe systems and radiators with 50mm spaced connections. All include isolation valve facilities. In addition RLV-KD models incorporate a radiator drain-off facility.

They are available with bottom connections for pipes coming from below, and back connections for pipes coming from behind. Two radiator connection standards are in use: one in which the radiator incorporates a 1/2" internal thread and another a 3/4" external thread. H-pieces are available for both connection methods.

### Sensors for Built-in Valves

Valve radiators fitted with Danfoss built-in valves can be fitted with any of the sensors in the RAS-C<sup>2</sup>, RAS-D<sup>2</sup> or RA2000 ranges. In situations where radiators are pre-fitted with inserts, which have a M30 x 1.5mm union nut connection to the sensor, the special purpose RAS-DK sensor is available.

Please note: A full range of compression fittings for copper, PEX and ALUPEX pipe are available, see page 19 for details.

### Additional information:

Compression fittings p.19



RLV-KS (back connection)



RLV-KD (bottom connection)



RAS-DK Sensor

- Convenient connections to radiators with 50mm centre connections
- Available with 1/2" internal and 3/4" external connections to the radiator
- Wide range of fittings to connect to copper, PEX and ALUPEX pipe
- Isolation valves built-in as standard

RLV-KD H-Pieces with Drain Facility <sup>(1)</sup>	
Code No	Description
003L024000	Bottom Connection for use with Radiators having 1/2" Internal Connections
003L024200	Back Connection for use with Radiators having 1/2" Internal Connections
003L024100	Bottom Connection for use with Radiators having 3/4" External Connections
003L024300	Back Connection for use with Radiators having 3/4" External Connections
RLV-KS H-Pieces without Drain Facility <sup>(1)</sup>	
003L022000	Bottom Connection for use with Radiators having 1/2" Internal Connections
003L022200	Back Connection for use with Radiators having 1/2" Internal Connections
003L022100	Bottom Connection for use with Radiators having 3/4" External Connections
003L022300	Back Connection for use with Radiators having 3/4" External Connections
Accessories for H-Pieces	
003L015200	Drain-Cock adaptor for use with RLV-KD H-Pieces

(1) Order pipe fittings separately, see page 19

Sensors for use with Built-In Valves with Danfoss Sensor Connections	
Code No	Description
013G617600	RAS-D <sup>2</sup> white/chrome built-In Temperature Sensor Range 8-28°C
013G617000	RAS-D <sup>2</sup> all chrome built-In Temperature Sensor Range 8-28°C
013G604000	RAS-C <sup>2</sup> Built-In Temperature Sensor Range 8-28°C
013G291000	RA2910 Built-In Temperature Sensor Range 5-26°C
013G291400	RA2914 Built-In Temperature Sensor Range 5-22°C
Sensors for use with Built-In Valves M30 x 1.5mm Threaded Connection	
013G506000	RAS-DK Built-In Temperature Sensor Range 8-28°C



# Bathroom Solutions

## RA-URX, RA-RTX and VHS-UN



RA-URX Chrome



VHS-UN Back Connection



VHS-UN Cover

- Valve screws directly into towel rail, completely hiding the tail piece from view
- Valve is self-sealing, reducing installation time
- Lockshield valve offers a drain-off feature and matching cap
- Standard Danfoss drain-cock can be used

### Thermostatic Towel Rail Valves

This luxury valve range is specifically designed for towel rails. Its innovative self-sealing 1/2" valve to radiator connection makes for a seamless, elegant and easy installation.

Valves and sensors are available in white and chrome, matching the most common towel rail colours. The elegant range provides the perfect finishing touch for towel rails. The aesthetically pleasing and compact design allows the sensor to be mounted underneath the towel rail, parallel with the wall, avoiding the risk of accidentally knocking the sensor.

### RA-URX Room Temperature Sensor

A room temperature sensor, developed with the purpose of controlling the room temperature in bathrooms where the towel rail is the primary source of heating. Both towel rail valve sets include a matching lockshield valve with drain-off function.

### RA-RTX - Return Temperature Limiter

Ideal for applications where the towel rail is the secondary source of heating and where keeping the towel rail warm, disregarding the room temperature, is a priority. To ensure that towels are always warm and dry, the RTX measures the temperature on the return flow, which can be adjusted independent of the room temperature.

### VHS-UN

The VHS valve is specifically designed for use with towel rails or designer radiators, having 50mm spaced connections. The VHS valve, which is available in versions with either bottom connections for pipes rising from the floor or with back connections for pipes coming from behind, integrates the functions of radiator thermostat, lockshield valve and connection system into one compact, easy to install unit.

The valve can be used together with RAS-C<sup>2</sup> or RAS-D<sup>2</sup> sensors. In addition a snap-on cover can be added to enhance the aesthetic appearance.

Set <sup>(1)</sup> complete with TRV valve body & sensor plus lockshield valve	Chrome	Soft White RAL 9010	Bright White RAL 9016	Temp. Range Xp = 2°C
	Code No			
RA-URX Left Mounted Sensor <sup>(2)</sup>	013G400400	013G400600	013G400800	8 - 28°C
RA-URX Right Mounted Sensor <sup>(2)</sup>	013G400300	013G400500	013G400700	
RA-RTX Left Mounted Limiter <sup>(2)</sup>	013G413300	013G413500	013G413700	10 - 50°C
RA-RTX Right Mounted Limiter <sup>(2)</sup>	013G413200	013G413400	013G413600	
<b>Accessories</b>			<b>Code No</b>	
Drain-Cock for the Lockshield Valve			003L15200	
Notes:				
(1) Order fittings separately, see page 19				
(2) All RA-URX radiator thermostat valve bodies must be mounted in return				

VHS-UN H-Piece with Integrated Radiator Thermostat Valve and Lockshield Valve <sup>(1)</sup>	
Code No	Description
013G474100	Valve with Back Connections for use with Radiators with 1/2" Internal Connections
013G474200	Valve with Bottom Connections for use with Radiators with 1/2" Internal Connections
(1) Order fittings separately, see page 19	
Sensors for use with VHS-UN Valve Bodies	
013G617600	RAS-D <sup>2</sup> Built-In Sensor, Chrome/White, range 8-28°C
013G617000	RAS-D <sup>2</sup> Built-In Sensor, All Chrome, range 8-28°C
Optional Valve Covers	
013G476200	Soft White (RAL 9010) Cover for use with Bottom Connection VHS Valve (Square Design)
013G475100	Soft White Cover for use with Back Connection VHS-UN Valve (Round Design)
013G476100	Soft White Cover for use with Back Connection VHS-UN Valve (Square Design)
013G478000	Chrome Cover for use with Bottom Connection VHS-UN Valve (Square Design)
013G477900	Chrome Cover for use with Back Connection VHS-UN Valve (Square Design)
Accessories	
003L015200	Drain-Cock Adaptor for use with VHS-UN & RA-URX Valve

# Replacement Sensors, Gland Seals and Accessories

## Gland Seal

- Just 2 gland seals cover the whole range of Danfoss valves
- Can be replaced without draining down the system

## Replacement Sensor

- Allows easy upgrade of old valves without the need to drain down
- Versions available for RAVL and RAV valve bodies
- Available in built-in and remote sensor versions

As part of our commitment to service, Danfoss produces a range of built-in and remote sensors that fit directly to older RAV and RAVL valve bodies.

## Replacement Sensors

Replacement sensors incorporate RA2000 sensor technology and design, and provide a simple and straight forward way to upgrade older radiator thermostats without the need to drain down the system.

## Gland Seals

As part of any upgrade, Danfoss recommends that the valve gland seal also be replaced. These can be replaced without draining down the system.

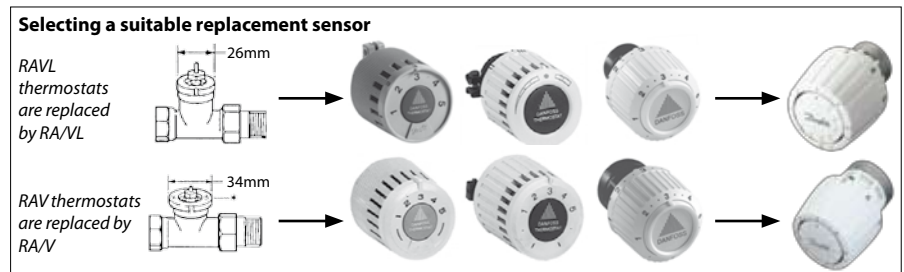

RA2000 Replacement Sensors and Gland Seals						
Existing Valve Body Dimensions	Existing Valve Body Type	Replacement Sensor - please note: the Code No's have changed				
		New Code No	Old Code No	Sensor Type	Description	Temp Range (Xp = 2k)
 26mm	RAVL	013G295000	013G221000	RA/VL	Built-In Sensor	5 - 26°C
		013G295200	013G221200	RA/VL	Remote Sensor 2m Capillary	
 34mm	RAV	013G296000	013G231000	RA/V	Built-In Sensor	5 - 26°C
		013G296200	013G231200	RA/V	Remote Sensor 2m Capillary	
 17mm	RA-FR RA-FS	Refer to RAS-C <sup>2</sup> and RAS-D <sup>2</sup> Sensors on p. 8 and 9. For more information visit <a href="http://www.danfoss-randall.co.uk">www.danfoss-randall.co.uk</a>				
	RA-FN RA-G RA-N	Refer to RA2000 Sensors on p. 10. For more information visit <a href="http://www.danfoss-randall.co.uk">www.danfoss-randall.co.uk</a>				

Gland Seals	
Code No	Description
013G029000	Gland Seal Assembly for RA-FS, RA-FR, RA-FN, RA-N and RA-G Valves
013U007000	Gland Seal Assembly for RAV and RAVL Valves

Accessories for RAS, RAS-D <sup>2</sup> & RA2000 Sensors and Valves				
Code No	Description	RAS-C <sup>2</sup>	RAS-D <sup>2</sup>	RA2000
013G123200	Anti-Theft for Sensors (50 pieces)			•
013L123400	Range Displacement Caps (20 pieces)	•	•	•
013G123700	Threaded Range Limiting pins (30 pieces)			•
013G123300	RA2020 Scale Cover (20 pieces)			•
013G123600	Toolkit, comprising Allen Key & Locking Pin Tool			•
013G123000	Accessory Bag for RA2000 Remote Sensor Base, Fixing Screw and Capillary Caps			
013G524000	Accessory Bag for RAS-D <sup>2</sup> Remote Sensors, including Sensor Base, Fixing Screw and Capillary Caps			

Accessories for RA2000 Remote Adjusters	
013G519300	Adaptor for RA5062, 5065 & 5068 for RAV Valves
013G519200	Adaptor for RA5062, 5065 & 5068 for RAVL Valves

Accessories for RA-FS, RA-FN, RA-N & RA-G Valves					
Code No	Description	RA-FS	RA-FN	RA-N	RA-G
013G500000	Manual Positive Shut-Off Knob	•	•	•	•
013G500100	Blanking Cap for Valve Outlet	•			
013G027500	Spare Protective Cap	•	•	•	•

# For Copper, PEX and ALUPEX Pipe Compression Fittings



ALUPEX Fittings

Copper Fittings

PEX Fittings

To support the range of radiator thermostats, Danfoss offers a wide range of compression fittings for valves.

**Additional Information:**

For a full range of fittings for non-standard pipe sizes, please see the RA2000 catalogue.

Spare Fittings	
for:	RAS-C <sup>2</sup> and RAS-D <sup>2</sup> Radiator Thermostat Combi Packs, RA-FR & RA-FS Radiator Thermostat Valve Bodies, RLV-D Lockshield Valves
Pipe Type:	<b>Copper</b>
013G028000	15mm fittings set, complete with olives, tailpiece and nuts
013G028100	8/10mm fittings set, complete with olives, tailpiece and nuts
013G084800	15mm olive
013G081700	10mm olive
013G081600	8mm olive
<i>Please note: Copper pipe must be in accordance with BS2871 part 1/BSEN1057. It is recommended to use supporting bushes with soft copper pipes.</i>	
<i>Design: For use with reversible angled pattern valve bodies, fitting have 1/2" internally threaded compression nut.</i>	
For Valves with Female Threaded Connections	
Compression Fittings for:	RA-FN & RA-N Radiator Thermostat Valve Bodies, RLV and RLV-D Lockshield Valve Bodies, RA-URX Towel Rail Valve Bodies, FJVR Return Temperature Limiter Valve Bodies and KOVM 3-Port Valve Bodies
Pipe Type:	<b>Copper</b>
013G410000	3/8" x 10mm
013G410200	3/8" x 12mm
013G410800	1/2" x 8mm
013G411000	1/2" x 10mm
013G411200	1/2" x 12mm
013G411500	1/2" x 15mm
Pipe Type:	<b>PEX</b>
013G414200	1/2" x 12 x 2.0mm
013G414400	1/2" x 14 x 2.0mm
013G414700	1/2" x 15 x 2.5mm
Pipe Type:	<b>ALUPEX</b>
013G417200	1/2" x 12 x 2mm
013G417400	1/2" x 14 x 2mm
<i>Please note: Copper pipe must be in accordance with BS2871 part 1/BSEN1057. It is recommended to use supporting bushes with soft copper pipes. PEX pipe must be in accordance with DN16892/16893 or BS7291 part 1:1990 or part 3:1990. Maximum operating pressure and temperature are given by the pipe manufacturer. However, 6 bar and 95°C must not be exceeded.</i>	
<i>Design: For use with valves having a female threaded connection. Fitting comprises olive and externally threaded compression nut, dimension of female thread is included in the description. For PEX and ALUPEX a pipe support insert is also included.</i>	
For Valves with Male Threaded Connections	
Compression Fittings for:	RLV-KD AND RLV-KS H-Pieces, VHS H-Pieces, FHV-R and FHV-A Underfloor Heating Valves, FHF-F Manifolds, RA-C Climate Valves and VMT- 2-Port Valves
Pipe Type:	<b>Copper</b>
013G412000	3/4" x 10mm
013G412200	3/4" x 12mm
013G412500	3/4" x 15mm
Pipe Type:	<b>PEX</b>
013G416500	3/4" x 15mm x 1.7mm
013G415500	3/4" x 15mm x 2.5mm
013G415600	3/4" x 16mm x 2.0mm
013G416300	3/4" x 16mm x 2.2mm
013G415900	3/4" x 18mm x 2.5 mm
013G416100	3/4" x 20mm x 2.5mm
Pipe Type:	<b>ALUPEX</b>
013G418400	3/4" x 14mm x 2.0mm
013G418500	3/4" x 15mm x 2.5mm
013G418600	3/4" x 16mm x 2.0mm
013G418800	3/4" x 18mm x 2.0mm
013G419000	3/4" x 20mm x 2.0mm
<i>Please note: Copper pipe must be in accordance with BS2871 part 1/BSEN1057. It is recommended to use supporting bushes with soft copper pipes. PEX pipe must be in accordance with DN16892/16893 or BS7291 part 1:1990 or part 3:1990. Maximum operating pressure and temperature are given by the pipe manufacturer. However, 6 bar and 95°C must not be exceeded.</i>	
<i>Design: For use with valves having a 3/4" male threaded connection. Fitting comprises olive and internally threaded compression nut. For PEX and ALUPEX a pipe support insert is also included.</i>	



# Time Controls Product Selector

<b>Domestic Timeswitches</b>				
<b>Electronic</b>			<b>Electro-Mechanical</b>	<b>Page</b>
<i>24 Hour</i>	<i>5/2 Day</i>	<i>7 Day</i>	<i>24 Hour</i>	
TS715 Si	TS715 Si	TS715 Si		<b>22</b>
	103E7	103E7		<b>24</b>
SET1E				<b>25</b>
			103	<b>24</b>

<b>Domestic Mini-Programmers</b>				
<b>Electronic</b>			<b>Electro-Mechanical</b>	<b>Page</b>
<i>24 Hour</i>	<i>5/2 Day</i>	<i>7 Day</i>	<i>24 Hour</i>	
	102E7	102E7		<b>24</b>
SET2E				<b>25</b>
			102	<b>24</b>
			3020P	<b>26</b>
			3060	<b>26</b>

<b>Domestic Two-Channel Programmers</b>				
<i>(With Common Time Base)</i>				
<b>Electronic</b>			<b>Electro-Mechanical</b>	<b>Page</b>
<i>24 Hour</i>	<i>5/2 Day</i>	<i>7 Day</i>	<i>24 Hour</i>	
CP715 Si	CP715 Si	CP715 Si		<b>22</b>
SET3E				<b>25</b>
			SET3M	<b>25</b>
			4033	<b>26</b>

<b>Domestic Two-Channel Programmers</b>				
<i>(With Independent Time Bases)</i>				
<b>Electronic</b>			<b>Page</b>	
<i>24 Hour</i>	<i>5/2 Day</i>	<i>7 Day</i>		
FP715 Si	FP715 Si	FP715 Si	<b>22</b>	
	FP975	FP975	<b>23</b>	

<b>Commercial Time Controls</b>				
<i>(All Models are 7 Day Electronic)</i>				
<b>Timeswitches</b>		<b>Bell-ringers</b>		<b>Page</b>
<i>1-Channel</i>	<i>2-Channel</i>	<i>1-Channel</i>	<i>2-Channel</i>	
811				<b>27</b>
851	852			<b>27</b>
		841	842	<b>27</b>



# Time Controls

## Accurate Trouble-Free Programming Every Time

<i>MK18 Range - FP715Si, CP715Si and TS715Si</i> .....22 Time Controls with Service Interval	<i>SET Range - SET1E, SET2E, SET3E and SET3M</i> .....25 Time Controls
<i>FP975</i> .....23 Replacement Time Control	<i>MK3 Range - 3020P, 3060 and 4033</i> .....26 Programmings
<i>GP Range - 102, 102E7, 103 and 103E7</i> .....24 Timeswitches and Mini-Programmings	<i>MK8 Range - 811, 851, 852, 841 and 842</i> .....27 Commercial Time and Bell-Ringing Controls



# Time Controls with Service Interval MK18 - FP715Si, CP715Si and TS715Si

**For use in any domestic heating and hot water function the MK18 range has a model for any situation, offering unrivalled flexibility of control.**

The MK18 range offers flexibility and reliability, with an elegant look and some handy features. All models have a slim, modern enclosure and a large LCD with a convenient back light.

Employing the latest technology, these flexible domestic heating time controls are reliable and easy to use. They are the installer's first choice due to their ready interchangeability with most other existing controls.

All models have real time and date set in the factory and automatically display the real time when powered up. The time and date information is used to automatically change between summer and wintertime on the right day each year without user intervention, substantially reducing the number of call backs.

All products also incorporate an installer set service interval timer for use in tenanted properties where the landlord is responsible for gas safety. This feature allows the service due date to be set and starts to remind the user 28 days before the due date.

Each model can be configured by the installer at time of installation to provide 7 day, 24 hour or 5 day/2 day operation. All models can also be configured to provide either 2 ON/OFF's or 3 ON/OFF's per day.

**Additional Information:**

Wallplate Information p. 70

Wiring Information p. 71



TS715Si



CP715Si



FP715Si

- **Service interval function**
- **7 day, 5/2 day or 24 hour**
- **Permanent back lit display**
- **AM/PM or 24 hour display**
- **Built-in programmes**
- **Automatic BST/GMT time change**
- **Convenient user overrides**
- **Holiday function**
- **'Industry standard' wallplate**
- **Factory set clock**

Features	TS715 Si	CP715 Si	FP715 Si
Code No.	087N789900	087N789700	087N789800
Single channel timeswitch	•		
Two channel programmer, with common timebase		•	
Two channel full programmer, with independent timebase			•
Service interval timer available, select at time of installation	•	•	•
7 day, 24 hour or 5/2 day operation, select at installation	•	•	•
2 on/off's or 3 on/off's per day, select at installation	•	•	•
Pumped or gravity hot water option, select at installation		•	•
Permanent back lit display	•	•	•
Output channels	single	independent HW & CH	
Programmes selectable	On/Off/Auto/Allday <sup>(1)</sup>		
Programmable holiday function	Up to 99 days		
Factory set real time clock	•		
Automatic BST/GMT change	•		
Service interval timer	Programmable between 2 and 12 months		
Factory pre-set on/off time	•		
Advance override	•	per channel	
+1 hour override	•	per channel	
Voltage rating	230 Vac ± 15%, 50/60 Hz		
Contact Rating	3 (1) A		
Switching action	1 x SPDT (voltage free)	2 x SPDT (commons linked internally)	
Battery backup on power failure	Time and all other settings - indefinitely		
Maximum ambient temperature	45°C		
Dimensions (mm)	137 wide x 93 high x 29 deep		
<i>Please note: (1) Per channel on CP and FP models</i>			

# Replacement Time Control FP975



FP975

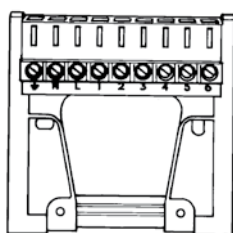

SET Wallplate (As supplied)

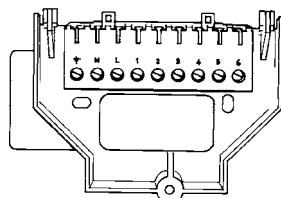

MK9 Wallplate (Discontinued)

- Fits SET and MK9 wallplates
- Ideal for service replacement
- 'Industry standard' wallplate
- Convenient user overrides
- Simple GMT/BST time change
- AM/PM or 24 hour display
- Day programme copy facility
- Built-in programmes
- Battery back up

**A convenient upgrade from MK9, SET5 or any model using British Gas standard wallplate.**

The FP975 full programmer offers a direct plug-in replacement to the Danfoss MK9 range (types 922 and 972), the Danfoss SET5, or any other timeswitch or programmer based on the British Gas standard wallplate.

The FP975 is supplied complete with SET wallplates but is designed to also mount directly onto existing MK9 wallplates without the need for wiring changes. Each unit, which when supplied is configured as a SET replacement, can be re-configured as a MK9 replacement by means of a switch on the rear of the unit.

**Additional Information:**

Wallplate Information p. 70  
Wiring Information p. 71

Features	FP975 <sup>(1)</sup>
Code No.	087N654300
7 day or 5/2 day	•
Two channel programmer, with independent timebase	•
Output channels	Independent HW & CH
Pumped gravity option available	•
Direct replacement for 922, 972 & SET5	•
Programmes selectable	On/Off/Auto/Allday
Factory pre-set on/off times	•
On and Offs per day	Up to 3
Advance override	per channel
+1hour override	per channel
Voltage rating	230 Vac ± 15%, 50/60 Hz
Contact Rating	3 (1) A
Switching action	2 x SPDT (voltage free)
Maximum ambient temperature	45°C
Memory back-up	Lithium - minimum of 24 hours
Dimensions (mm)	150 wide x 99 high x 42 deep

**Notes:**

(1) A version configured for two heating zones, type FP975-2H, code no. 087N759900 is also available.

For replacement of the TS975 please refer to the TS715 Si model - code number 087N789900, alternatively use FP975 and disregard HW channel

# Timeswitches and Mini-Programmers GP Range

**Ideal for systems where heating and domestic hot water are required at the same time.**

This range of general-purpose timeswitches and miniprogrammers, provides either a single output circuit (103 timeswitch range) or linked outputs for water and heating (102 mini-programmer range).

Both ranges include easy to use 24-hour electromechanical models, plus an electronic model which offers 7-day day operation.

All units fit the GP wallplate and have an identical wiring configuration, allowing systems to be upgraded without the need for rewiring.

The electro-mechanical 102 programmer and 103 timeswitch have a thumbwheel, which allows early selection of future switching operations.

All models show clearly the current state of the output.

The electronic unit has extra programmes and overrides, and incorporates a battery to provide back up of time and programme.

**Additional Information:**

Wallplate Information p. 70  
Wiring Information p. 71

**Please note:**

The 102E5 and 103E5 are no longer in manufacture. Please refer to the 102E7 and 103E7.



102E7



103

- **Proven reliability**
- **Easy to use**
- **All units interchangeable on the same wallplate**
- **Available in 24 hour and 5/2 day / 7 day versions**
- **Available in electro-mechanical and electronic version**

Features	102	103	102E7	103E7
Code No.	087N652100	087N652300	087N653600	087N653800
Electro-mechanical	24 hour			
Electronic			7 day or 5/2 day	
HW only or HW and CH	•		•	
Programmes selectable	Water only Off Water & Heating	Timed Off On		Off Auto Allday On
Factory pre-set programmes (all changeable)				•
On/Offs per day	2		3	
Advance override			•	
+1 hour override				•
Voltage rating	230 Vac ±15%, 50/60 Hz			
Contact rating	6 (2.5) A		3 (1) A	
Switching action	SPST (voltage free)			
Maximum ambient temperature	55°C		45°C	
Memory back-up	N/A		min. of 24 hours	
Dimensions (mm)	106 wide x 135 high x 63 deep		102 wide x 136 high x 47 deep	



# Time Controls SET Range



SET1E



SET3E



SET3M

- Easy to operate
- 24 hour control
- Easy to use rocker switches
- British Gas standard wallplate
- Available in electro-mechanical and electronic versions

*For situations where simplicity of control is paramount.*

The SET range of time controls has been designed with simplicity of programming and use in mind.

The range includes an electronic timeswitch, a mini-programmer and a programmer, as well as an electro-mechanical programmer.

All models offer 24 hour control and are designed to fit the British Gas Standard Wallplate used by earlier SET models and some models from the Horstmann range.

All models have LED status indicators and have easy to use rocker switches for programme selection.

The On/Off times can be seen at a glance on the SET3M. Using the slider switch on the electronic models the on/off times are shown on the large, clear display.

Programmes can be manually overridden, by the thumbwheel on the SET3M and by the ADVANCE and +1HR buttons on the electronic models.

**Additional Information:**

Wallplate Information p. 70  
Wiring Information p. 71

Features	SET1E	SET2E	SET3E	SET3M
Code No.	087N654000	087N654100	087N654200	087N653200
Timeswitch	•			
Mini-programmer		•		
Two channel programmer, with common timebase			•	•
Electronic	24 hour	24 hour	24 hour	
Electro-mechanical				24 hour
Pumped/Gravity option			•	•
Programmes selectable	Off Timed On	Off Timed On	Off Timed On (Water)	Off Timed On (Water)
		HW or HW & CH	Off Timed On (Heating)	Off Timed On (Heating)
Factory pre-set programmes		•		
On & offs per day	2	2	2	2
Advance override	•	•	•	•
+1hour override	•	•	•	
Voltage rating	230 Vac ± 15%, 50/60 Hz			
Contact Rating	3 (1) A			
Switching action	1 x SPDT (voltage free)	2 x SPDT (voltage free)		2 x SPDT (voltage free)
Maximum ambient temperature	45°C			
Memory back-up	Up to 24 hours			N/A
Dimensions (mm)	158 wide x 98 high x 36 deep			158 wide x 98 high x 63 deep

# Programmers MK3 Range - 3020P, 3060 and 4033

**For situations where simplicity of control is paramount.**

This range of basic electro-mechanical time controls, for heating and domestic hot water systems, is noted for its ease of operation.

The control modules plug into a separate wallplate/terminal block, making installation and servicing as simple as possible.

All models feature a 24 hour clock with colour coded ON and OFF tappets, which are simply moved to the desired position on the dial to provide 2 On and Off periods per day.

Programme selection is made by means of easy to understand rotary switch or toggle switches.

### MK3 Factory Replacement Units

MK3 models, minus the wallplate/terminal block, for fast in-service replacement. Just plug the module into the existing wallplate and fit the new outer casing.

### Additional Information:

Wallplate Information p. 70

Wiring Information p. 71



3020P



4033



3060

- **Easy to operate**
- **Available in mini-programmer and programmer versions**
- **Factory replacement units are available**

Features	3020P	3060	4033		
Code No.	087N652600	087N652800	087N653000		
Type	Mini-programmer	6 position programmer	Two channel programmer		
Electro-mechanical	24 hour				
Programmes selectable	Timed Off On	Heating Off Twice Once <sup>(1)</sup> On Twice <sup>(2)</sup> Off	Water Off Twice Once <sup>(1)</sup> On Once <sup>(1)</sup> Twice <sup>(2)</sup>	Heating Timed Off On	Water Timed Off On
	Water only Water & heating				
On/offers per day	2				
Voltage rating	230 Vac ±15%, 50/60 Hz				
Contact rating	3 (1) A				
Switching action	2 x SPST	2 x SPST	2 x SPDT		
Maximum ambient temperature	55°C				
Dimensions (mm)	102 wide x 210 high x 60 deep				
Notes (1) Once = all day between 1st On and last Off (2) Twice = 2 ons and 2 offs per day					

FRUs	Description	Code No.
Factory Replacement Units (standard units without backplate)	3020P FRU replacement module and case	087N655700
	3060 FRU replacement module and case	087N655900
	4033 FRU replacement module and case	087N656000
	3022 FRU replacement module and case This module is for optional water priority or heating priority 3 port diverter valve control systems	087N655800

Note: Specification as non-FRU models

# Commercial Time and Bell-Ringing Controls MK8 Range - 811, 851, 852, 841 and 842



851



852



841

- 7 day operation
- 200 event memory
- Key protection
- Battery back-up
- EXTEND or CROP overrides
- Volt-free contacts

Features	811	851	852	841	842
Code No.	087N656600	087N657200	087N657500	087N656800	087N657100
Single channel	•	•		•	
Two independent channels			•		•
Up to 200 on or off outputs per week	•	•	•		
Up to 200 intermittent or continuous PULSED outputs per week				•	•
EXTEND override(s)	•	•	2		
CROP override(s)	•	•	2		
Different pulse type possible for each channel					•
Pulse duration (select on installation)				1 to 15 seconds	1 to 15 seconds per channel
MANUAL momentary override				•	• <sup>(3)</sup>
Voltage rating	230 Vac ± 15%, 50/60 Hz Other voltages made to special order				
Switching current rating	Resistive: 30A Inductive: 10A	10A 4A	10A <sup>(1)</sup> 4A	15A 5A	3A <sup>(3)</sup> 1A
Contact type <sup>(2)</sup>	SPST	SPDT	2 x SPDT	SPST	2 x SPDT
Dimensions (mm)	228 wide x 115 high x 50 deep				

**Notes:**

(1) Total rating for both channels

(2) All contacts are voltage free

(3) Per channel

The MK8 range of 7 day commercial and industrial controls includes On/Off units for boiler control, lighting, bell ringing and siren-sounding applications, i.e. class change bell-ringing in schools or for breaks and shift changes in factories.

Programme entry is via a membrane keypad with audible feedback. For security it is only possible to enter or change the time, programme and extend duration with the removable key in place and turned to the setting position.

The On/Off units 811, 851 and 852 feature a programmable 0 to 8 hour extend or continuous override and a crop override to cancel the remainder of an on period. The Auto/Off rocker switches allow outputs to follow the programmed events or to be switched off.

The pulsed units 841 and 842 feature programmable duration and pulse type, continuous or intermittent. The Auto/Off/Man rocker switches allow the outputs to follow the programmed events, to be switched off, or to be manually on while the switch is held down in this position.

**Additional Information:**

Wiring Information p. 75



# Electric Thermostats Product Selector

Dial Setting Room Thermostats for Heating Applications										
Electro-mechanical			Electronic							
Hard-wired			Hard-wired					Wireless		Page
24 volt	230 volt	Page	Battery	24 volt	230 volt			Battery		
			Standard (with LCD)	Standard	Standard	Standard (with LCD)	Delay start (with LCD)	Standard (with LCD)		
RMT24		<b>38</b>	RET B						<b>39</b>	
RMT24T		<b>38</b>	RET B-LS						<b>39</b>	
	RMT230*	<b>38</b>		RET24	RET230P				<b>38</b>	
	RMT230	<b>38</b>		RET24VF	RET230				<b>38</b>	
	RMT230T	<b>38</b>		RET24NSB	RET230L				<b>38</b>	
					RET230VF2				<b>38</b>	
					RET230NSB				<b>38</b>	
						RET M	RET MD		<b>40</b>	
								RET B-RF	<b>39</b>	
								RET B-LS-RF	<b>39</b>	
						FMT230D			<b>42</b>	

Note: RET B models can also be used for cooling applications.

Programmable and Set-back Room Thermostats with Digital Display for Heating Applications										
Set-back			Programmable							
Hard-wired	Wireless	Page	Hard-wired					Wireless		Page
Battery			Battery			230 volt		Battery		
Standard	Standard		24 hour	5/2 day	7 day	5/2 day	7 day	5/2 day	7 day	
RT51	RT51-RF	<b>34</b>		TP7000	TP7000	TP7000M	TP7000M	TP7000-RF	TP7000-RF	<b>32</b>
				TP5000 Si		TP5000M Si		TP5000-RF Si		<b>31</b>
			TP4000							<b>30</b>
						TP9000	TP9000			<b>33</b>

Note: TP9000 incorporates a time control channel for hot-water.

Programmable Room Thermostats with Digital Display for Heat/Cool Applications							
Hard-Wired							
Battery			230 volt				Page
24 hour	5/2 day	7 day	24 hour	5/2 day	7 day		
	6000			6000		<b>37</b>	

Dial Setting Room Thermostats for Heat/Cool Applications				
Cool only	Heat only	Heat or Cool	Heat/Cool (Manual c/o)	Page
RET230-C3	RET230-H3		RET230-C01	<b>41</b>
RET230-C32		RET230-LS	RET230-C02	<b>41</b>
			RET230-C03	<b>41</b>
			RET230-C04	<b>41</b>

Dial Setting Room Thermostats with Auto Changeover		
2-Pipe <sup>(1)</sup>	4-Pipe	Page
RET230 HCW-1		<b>43</b>
RET230 HCW-3	RET230 HC-1	<b>43</b>
	RET230 HC-3	<b>43</b>

(1) Changeover based on pipe temperature.

Other Thermostats					
Open Therm Thermostats	Frost	Cylinder	Pipe	Immersion	Page
ORT-01					<b>44</b>
ORT-10					<b>44</b>
	RET230F				<b>45</b>
	RET230F5	ATC			<b>45</b>
		WP75-RF			<b>36</b>
	ATF	CET B-RF	ATP		<b>45</b>
				ITC	<b>46</b>
				ITL	<b>46</b>
				ITD	<b>46</b>

Note: WP75-RF is programmable. WP75-RF and CET B-RF are wireless.



# Electric Thermostats

## For Optimum Temperature Control

<i>TP4000 Programmable Room Thermostat</i> .....30 24 Hour Programming	<i>RET-B</i> .....39 Battery Powered Room Thermostat with Setting Dial
<i>TP5000 Si Programmable Room Thermostat</i> .....31 24 Hour or 5 Day/2 Day Programming	<i>RET-M and RET-MD</i> .....40 Room Thermostats with Delay Start
<i>TP7000 Programmable Room Thermostat</i> .....32 7 Day or 5 Day/2 Day Programming	<i>RET230</i> .....41 Room Thermostats with Function Switches
<i>TP9000 Programmable Room Thermostat</i> .....33 With Hot Water Control	<i>FlatStat FMT230D</i> .....42 Flush Mounted Thermostat
<i>RT51 and RT51-RF</i> .....34 Set Back Thermostat	<i>RET230 HC and RET230 HCW</i> .....43 Heat/Cool Room Thermostat
<i>Radio Frequency Heating Controls</i> .....35 Secure Digital Communication	<i>ORT Modulating Thermostat</i> .....44 For use with OpenTherm Boilers
<i>WP75-RF</i> .....36 Hot Water Programmable Room Thermostat	<i>ATC, ATP, ATF, RET230F and CET B-RF</i> .....45 Cylinder, Pipe and Frost Thermostats
<i>6000 Series</i> .....37 Heat/Cool Programmable Thermostats	<i>ITC, ITL and ITD</i> .....46 Immersion Thermostats
<i>RMT and RET</i> .....38 Room Thermostats with Setting Dial	<i>Load Compensator Control Technology</i> .....47 Chrono-Proportional



# Programmable Room Thermostat TP4000 (24 Hour)

**Easy to use programmable thermostat providing different temperatures at different times of the day; ideal for Combi boiler installations.**

The TP4000 programmable room thermostat combines the functions of a timeswitch and room thermostat into an easy to use unit, which provides up to six time and temperature events per day.

This flexibility allows the operation of the heating system to be matched to the lifestyle of the user, providing different temperatures at different times of the day.

The TP4000 is a 24 hour room thermostat, where the demand is for the same programme each day. Temporary adjustments can be made to control temperature but the override is cancelled at the beginning of the next event. It also has an easy to use 'frost protection' setting feature.

The TP4000 is designed with modern times in mind and is available in hard-wired or wireless versions.

**Additional Information:**

Wiring Information p. 71



TP4000



RX1

- **Large, easy to read display**
- **24 hour programming**
- **Easy to programme and operate**
- **Battery powered**
- **Compact design**
- **Factory pre-set programmes**
- **Built-in frost protection**
- **Chrono-proportional or on/off**

Hard-wired versions	TP4000	TP4000-RF + RX1	TP4000-RF
Code No.	087N791900	087N792100	087N792000
Hard-wired, with built in sensor	•		
Wireless, with built in sensor			•
Wireless, with built in sensor + RX1 receiver		•	
Temperature range	Off, 5-30°C		
Programming	24 hour		
Number of events per day	6		
Clock Display	AM/PM or 24 hour		
Factory pre-set programmes	•		
Control Type	Chrono-proportional or on/off		
Room temperature override	•		
Frost protection	Fixed 5°C		
Temperature accuracy	± 1°C		
Time accuracy	± 1 minute		
Voltage rating of output	10-250 Vac		N/A
Current rating of output	3 (1) A		N/A
Switching action	1 x SPDT voltage free		N/A
Maximum ambient temperature	45°C		
Power supply	2 x AA/MN1500/LR6 alkaline batteries		
Transmission Frequency (RF models)	N/A	433.92MHz	
Transmission Range	N/A	30 metres max.	
Memory retention	Events retained for life of product Up to 1 minute whilst changing batteries		
Dimensions (mm)	110 wide x 88 high x 28 deep		

Accessories	Description	Code No.
	Table Stand - For RT51-RF, TP4000, TP5000Si and TP7000 thermostats	087N791900

# Programmable Room Thermostat TP5000Si (24 Hour or 5/2 Day)



TP5000 Si



RX1

**Programmable thermostats provide different temperatures at different times of the day; ideal for Combi boiler and floor heating installations.**

The TP5000 Si range of programmable room thermostats offers easy to install and use 5/2 day thermostats with up to six time and temperature changes each day with different programmes for weekdays and weekends. Mains or battery powered for ease of installation, the TP5000 Si has a large, easy-to-read LCD display. It is easy to programme and operate because of a built-in switching programme that the user can easily change to suit individual heating requirements. The TP5000 Si is also available in wireless (RF) versions.

A big plus with the TP5000 Si is that it incorporates a real time clock and calendar function which eliminates the need for time-setting and BST/GMT time changes. Time and date are factory-set.

Chrono-proportional control is the standard setting for the TP5000 Si but advanced conventional ON/OFF control is an installer-set option. This modulating control mode uses a cycling pattern within which boiler on/off percentages are varied to satisfy heating requirements. Chrono-proportional cycling rates of 3, 6, 9 or 12 per hour can be selected.

### Service Interval Function

The optional Service Interval Function incorporated into the TP5000 Si helps landlords meet the boiler servicing requirements of Gas Safety Regulation 36. The unit provides audible and visual warnings from 28 days before servicing is due and ultimately reduces the heating output should the due date pass. Full heating operation can only be restored by an authorised installer.

### Additional Information:

Wiring Information p. 71

- Chrono-proportional or on/off
- Large easy to read LCD display
- Available in mains, battery-powered and wireless versions
- Easy to programme and operate
- Battery powered models for ease of installation
- Thermostat mode and frost protection
- Service interval function

Hard-wired versions	TP5000 Si	TP5000A Si	TP5000M Si	TP5000MA Si <sup>(3)(4)</sup>
Code No.	087N791000	087N791100	087N791700	087N791800
Wireless versions	TP5000-RF Si	TP5000A-RF Si		
Code without receiver	087N791200	087N791300		
Code for set c/w single channel receiver	087N791400			
Programmable operation	24 hour or 5/2 day			
Number of events per day	6, 4 or 2			
Temperature range	Off, 5-30°C			
Clock display	24 hour			
Factory pre-set programmes	Yes			
Room temperature override	Yes	Adjustable	Yes	Adjustable
Display time or temperature option	Yes			
Thermostat mode and frost protection	Yes			
Weekend into weekday override	Yes			
Control Type	Chrono-proportional or on/off control			
Power supply, thermostats	2 x AA/MN1500/LR6 alkaline batteries <sup>(1)</sup>		230Vac, 50Hz	
Maximum ambient temperature	45°C			
Contact type and rating (hard-wired models)	10-230 Vac, 3(1)A			
Transmission frequency (RF models)	433.92 MHz		-	
Transmission range (RF models)	30 metres max. <sup>(2)</sup>		-	
Dimensions (mm)	110 wide x 88 high x 28 deep			

**Notes:**

(1) Memory is retained for 1 minute during battery change

(2) Please ensure there are no large metal objects between thermostat and receiver as these will interfere with radio signal.

(3) Can be configured for remote temperature sensor, limit sensor, window contact or telephone activated switch contact.

(4) Remote sensor is supplied as an accessory, if remote sensor is required order TS2 sensor, code 087N681100

Receivers (RF models)	RX-1	RX-2	RX-2C	RX-3
Code No.	087N747600	087N747700	087N747900	087N747800
Number of zones receiver covers	1	2	2	3
Power supply (receivers)	230 Vac, ±15%, 50/60 Hz			
Contact details	1-SPDT	1-SPDT, 1-SPST	2-SPDT	1-SPDT, 2-SPST
Contact rating	10-230 Vac, 3(1)A			
Dimensions (mm)	138 wide x 88 high x 32 deep			

Accessories	Code No.
TS2 Remote Air Sensor	087N681100
TS3 Remote Floor Sensor	087N678400
Table Stand - For RT51-RF, TP4000, TP5000Si and TP7000 thermostats	087N791900

# Programmable Room Thermostat TP7000 (7 Day, 5/2 Day or 24 Hour)

**For situations where a higher flexibility of control is required.**

The TP7000 range includes hard-wired battery and mains powered models and a battery powered wireless model.

All models provide true 7 day programming options, with up to six time and temperature events being available each day. In addition to programmed set-back, all models can be set to turn off the heating if so desired.

To improve comfort and economy all models in the TP7000 range offer optional chrono-proportional control and optimum start control. These features are configured by the installer during commissioning.

For the user, many overrides, including a 99 day holiday programme, provide easy day to day use reducing the likelihood of call-backs.

**Additional Information:**

Wiring Information p. 71



TP7000



RX3

- True 7 day programming
- 7 day or 5/2 day operation
- Up to 6 time and temperature changes per day
- Built-in holiday function
- Optimum Start Control
- Chrono-proportional or On/Off Control
- Convenient user overrides
- Wallplate construction

Hard-wired versions	TP7000	TP7000A	TP7000M <sup>(1)</sup>	TP7000MA
Code No. - hard-wired models, built-in sensors	087N740000		087N740800	
Code No. - hard-wired models, remote sensor		087N740100		087N740900
Wireless versions	TP7000-RF	TP7000A-RF		
Code No. - wireless model, built-in sensor <sup>(2)</sup>	087N741000			
Code No. - wireless models, remote sensor		087N741100		
Code No. - for set c/w RX-1 receiver (single channel)	087N741800			
Temperature range (°C or °F display)	Off, 5-30°C (41-86°F)			
Time and temperature events per day	Up to 6			
Room temperature override	•			
Display time or temperature	•			
Thermostat mode	•			
Extend function 1, 2 or 3 hours	•			
Holiday function, up to 99 days	•			
Control Type	Chrono-proportional or on/off control			
Optimum start control	•			
Voltage rating of contacts (hard-wired models)	10-250 Vac, 50/60 Hz			
Current rating of contacts (hard-wired models) <sup>(3)</sup>	3(1)A			
Switching action of contacts (hard-wired models)	1 SPDT			
Transmitter frequency (wireless models)	433.92 MHz			
Transmitter range (wireless models)	30 metres <sup>(4)</sup>			
Power supply (Memory is retained for 1 minute during battery change)	2 x AA/LR6/MN1500 alkaline batteries <sup>(4)</sup>		230 Vac, ± 15%	
Maximum ambient temperature	45°C			
Dimensions (mm)	135 wide x 88 high x 28 deep			
<i>(1) TP7000M has battery back-up based upon Nickel Metal Hydride cell. This takes 6 days to fully charge, with a minimum of 24 hours before back-up service is available.</i>				
<i>(2) Requires RX receiver unit, please see table below.</i>				
<i>(3) When switching low voltage, contacts must carry a minimum of 10mA</i>				
<i>(4) Please ensure no large metal objects between thermostat and receiver, as these will interfere with radio signal</i>				

Receivers (RF models)	RX-1	RX-2	RX-2C	RX-3
Code No.	087N747600	087N747700	087N747900	087N747800
Number of zones receiver covers	1	2	2	3
Power supply (receivers)	230 Vac, ±15%, 50/60 Hz			
Contact details	1-SPDT	1-SPDT, 1-SPST	2-SPDT	1-SPDT, 2-SPST
Contact rating	10-230 Vac, 3(1)A			
Dimensions (mm)	138 wide x 88 high x 32 deep			

Accessories			
TS2 Remote Air Sensor 087N681100		TS3 Remote Floor Sensor 087N678400	
		Table Stand 087N791900	



# Programmable Room Thermostat with Hot Water TP9000 (7 Day, 5/2 Day or 24 Hour)



TP9000

- **Built-in hot water time control**
- **7-day, 5/2 day or 24 hour control**
- **Remote room temperature sensor available**
- **Advanced copy functions**
- **Holiday Mode**
- **Chrono-proportional or On/Off Control**
- **+1/+2/+3 hours boost**
- **Service interval function**

Features	TP9000
Code No.	087N789200
Room time and temperature changes	Up to 6 per day
Room temperature control range °C	Standard 5-30°C range Fully adjustable higher/lower limits
Remote room temperature sensor included	•
Control Type	Chrono-proportional or on/off control
Selectable 5/2 or 24 hr operating modes	•
Selectable 7 day operating mode	•
A+B day copy mode	•
Advanced copy mode	(copy to next day or any day of week)
DHW time control events	Up to 3 per day
Suitable for pumped systems	•
DHW only mode	•
Frost protection	•
Manual overrides (+/- hr)	+1, 2, or 3hr
Holiday mode	•
Optional Service Interval Timer	•
Auto/All Day/On/Off selection	•
Optimised or Delayed Start	•
Audible button press	•
Advanced programming mode	• <sup>(1)</sup>
Outside temperature sensor	• <sup>(2)</sup>
Power supply	230 Vac, ±15%, 50/60 Hz
Voltage and current rating of output contacts	230 Vac, 50/60 Hz, 3 (1) A max
Switching action	2 x SPDT (commons linked internally)
Maximum ambient temperature	45°C
Dimensions (mm)	137 wide x 93 high x 29 deep
Note: (1) Provides access to APM mode which contains numerous installer selectable options (2) Provides display of outside temperature on unit only – not used for optimisation functions	

Accessories	Code No.
TS2 Remote Air Sensor	087N681100
TS3 Remote Floor Sensor	087N678400

The TP9000 programmable room thermostat includes an extra timed circuit for controlling domestic hot water on/off times.

The TP9000 combines the benefits of a programmable room thermostat and a hot water timer in one unit.

Providing full 7 day control, as well as 5 day/2 day and 24 hour control, the TP9000 is suited for almost any timing requirement. Add to this an advanced copy function and A+B programming functionality and you have a truly versatile unit.

Holiday function, frost protection, optimum/delayed start and many more options are all selectable using the advanced programming mode allowing total control of your heating and hot water system.

Chrono-proportional control is available as well as traditional on/off control providing energy saving benefits.

**Additional Information:**  
 Wiring Information p. 71

# Digital Thermostat RT51 and RT51-RF

**Easy to use programmable thermostat which provides different temperatures at different times of the day; ideal for Combi boiler installations.**

For applications where it is necessary to run the central heating at a reduced level at night, the stylish RT51 offers a simple and cost effective solution.

The RT51, a slim and compact battery-operated digital thermostat, is ideal for both new installations and for upgrading existing systems. It is easy to use, with a large clear LCD display, and it allows the user to programme Day and Night temperatures which are then initiated manually by pressing two buttons. Once programmed, room temperatures are easy to alter using the ▲ and ▼ buttons.

Night setback is initiated manually but the return to Day mode is automatic at a predetermined time.

To save installer on-site time, the RT51 comes factory-set at 20°C 'Day' and 15°C 'Night'. The user can change these settings quickly and easily at any time to suit individual needs. The temperature setting range is 5°-30°C plus an 'Off' selection.

A wireless, radio-controlled version, type RT51-RF, is also available for applications where it is impractical to run cables between the room thermostat and the other control components in the system. Using radio transmissions the RT51-RF model communicates with the receiver unit, type RX, which can be located up to 30 metres away from the thermostat.

The receiver unit is available in three versions, offering either 1, 2 or 3 zones of control, each zone requiring its own RT thermostat.

### Additional Information:

Wiring Information p. 71



RT51



RX1

- Large, easy to read display
- Easy to programme and operate
- Battery powered for ease of installation
- Compact design
- Available in hard-wired and wireless versions
- Chrono-proportional or On/Off Control

Hard-wired versions	RT51	RT51-RF
Code No.	087N699600	
<b>Wireless versions</b>		
Code No. without receiver		087N699900
Code No. for set c/w single channel receiver		087N729900
Heating thermostat with manually selected Day/Night operation	•	•
Control Type	Chrono-proportional or on/off control	
Temperature range	Day: OFF, 5-30°C Night: OFF, 5-30°C	
Factory pre-set programme (can be changed)	Day: 20°C, Night: 15°C	
Contact current rating	3(1) A, 10-230 Vac	N/A
Switching action	SPDT	N/A
Transmitter frequency	N/A	433.92MHz
Transmitter range	N/A	30 m max. <sup>2</sup>
Power supply	2 x AA/MN1500/LR6 alkaline batteries <sup>1</sup>	
Maximum ambient temperature	45°C	
Dimensions (mm)	110 wide x 88 high x 28 deep	
<i>Notes:</i>		
(1) Memory is retained for 1 minute during battery change		
(2) Please ensure there are no large metal objects between thermostat and receiver as these will interfere with radio signal.		

Receivers (RF models)	RX-1	RX-2	RX-2C	RX-3
Code No.	087N747600	087N747700	087N747900	087N747800
Number of zones	1	2	2	3
Power supply (receivers)	230 Vac, ±15%, 50/60 Hz			
Contact details	1-SPDT	1-SPDT, 1-SPST	2-SPDT	1-SPDT, 2-SPST
Contact rating	10-230 Vac, 3(1)A			
Dimensions (mm)	138 wide x 88 high x 32 deep			

Accessories	Description	Code No.
	Table Stand - For RT51-RF, TP4000, TP5000Si and TP7000 thermostats	087N791900

# Radio Frequency Heating Controls

*Ideal for use in situations where it is impractical to run wiring between the thermostat location and other controls in the system.*

Using secure digital radio communication, the thermostats communicate with an RX receiver unit, which can be mounted up to 30 metres away from the thermostat.

The thermostats, all of which are battery powered, each have their own unique digital identity code, which is learnt by the RX receiver unit during commissioning. Receivers are available in 1, 2 or 3 channel versions, making them ideally suited to zoning applications. A two-zone receiver with a shared output heat demand relay is available for use where a common output is required for the control of a pump or boiler.

Thermostats in this range, include:

- RET B-RF dial setting room thermostat
- RT51-RF set-back room thermostat
- TP5000-RF 5/2 day programmable room thermostat
- TP7000-RF 7-day programmable room thermostat
- CET B-RF dial setting cylinder thermostat with clamp-on sensor
- WP75-RF 7-day programmable hot water thermostat with clamp on sensor.

### Wireless System Sets

Most models are available in convenient system sets comprising a thermostat and single channel receiver - see table below for details.

### Additional Information:

Wiring Information p. 71, 72 and 75



TP5000-RF Si and RX1 Receiver



RET B-RF and RX1 Receiver

- Available in dial setting, set-back and programmable versions
- Secure digital communication
- Thermostats are battery powered
- Receivers available in 1, 2 or 3 channel versions

Wireless thermostat system sets	Type	Code No
Room thermostat with setting dial (RET B-RF + RX-1)	RET B-RF	087N727600
Day/night thermostat set (RT51-RF + RX-1)	RT51-RF	087N729900
24 hour programmable thermostat set (TP4000-RF + RX-1)	TP4000-RF	087N792100
5/2 day programmable thermostat set (TP5000-RF Si + RX-1)	TP5000-RF Si	087N791400
7 day programmable thermostat set (TP7000-RF + RX-1)	TP7000-RF	087N741800
Cylinder thermostat with clamp-on sensor (CET B-RF + RX-1)	CET B-RF	087N727800
Individual wireless thermostats	Type	Code No
Dial setting thermostat	RET B-RF	087N727000
Day/night thermostat with manual return to day	RT51-RF	087N699900
24 hour programmable thermostat	TP4000-RF	087N792000
5/2 day programmable thermostat	TP5000-RF Si	087N791200
7 day programmable thermostat	TP7000-RF	087N741000
Dial setting cylinder thermostat c/w clamp on sensor	CET B-RF	087N727700
7 day programmable hot water thermostat	WP75-RF	087N685000
Thermostat Specification		
Room thermostat functions and features as per hard-wired models - refer to p. 30, 31, 32 and 34. For CET B-RF see p. 45		
Transmitter frequency	433.92 MHz	
Transmitter range	30 metres line of sight <sup>(1)</sup>	
<i>(1) Ensure there are no large metal objects between thermostat and receiver as these will interfere with radio signal.</i>		

Receiver features	RX-1	RX-2	RX-2C	RX-3
Code No	087N747600	087N747700	087N747900	087N747800
Single channel receiver works with 1 thermostat	•			
Two channel receiver works with 2 thermostats		•	•	
Three channel receiver works with 3 thermostats				•
Transmitter code self learning feature	•			
Receiver operating frequency	433.92 MHz			
Supply voltage	230 Vac, ± 15%, 50/60 Hz			
Contact rating	10-230 Vac, 3(1)A			
Output relay configuration, commons linked internally	1 x SPDT	1 x SPDT 1 x SPST	2 x SPDT	1 x SPDT 2 x SPST
Memory retention	Memory retained electronically on power down			
Dimensions (mm)	132 wide x 88 high x 32 deep			

Accessories	Description	Code No.
	Table Stand - For RT51-RF, TP4000, TP5000Si and TP7000 thermostats	087N791900

# Hot Water Programmable Thermostat WP75-RF (7 Day or 5/2 Day)

For use in domestic hot water applications.

### WP75-RF Wireless Model

The WP75-RF allows up to three different hot water temperatures to be programmed each day. For those periods where no water is required the water heater is turned off.

For convenience the WP75-RF includes a water status indicator, which provides the user with an indication of how much hot water there is in the cylinder.

The WP75-RF incorporates a convenient 'one shot boost' function, which allows the user to get a full cylinder of hot water, after which the system is turned off.

The WP75-RF is supplied with an electronic remote temperature sensor, which clamps onto the hot water cylinder wall.

The WP75-RF works in conjunction with an RX receiver module, designed for use in conventional gas or oil-fired systems, providing wireless communication between the thermostat and the receiver unit. They can be mounted up to 30 metres apart.

### Additional Information:

Wiring Information p. 71



WP75-RF



RX1 Receiver



CS1 Remote Sensor

- Provides up to 3 different hot water temperatures daily
- Can be set for 7 day or 5/2 day operation
- Convenient user overrides including 'one shot boost' and 'hot water indicator'

Features	WP75-RF
Code No.	087N685000 <sup>(1)</sup>
Wireless thermostat, refer to table below for RX-1 receiver details (order separately)	•
Temperature range	35 - 65 °C
7 day or 5/2 day programming options	•
Maximum number of events each day	3 on and 3 off
Factory pre-set programmes	•
Transmitter frequency	433.92 MHz
Transmitter range	30m line of sight <sup>(3)</sup>
Power supply	2 x AA/MN1500/LR6 alkaline batteries plus capacitor. No programme loss during battery change
Maximum ambient temperature - thermostat module	45°C
Maximum ambient temperature - sensor module	75°C
Dimensions - thermostat module (mm)	135 wide x 88 high x 43 deep
Dimensions - sensor module (mm)	48 wide x 48 high x 45 (or 80) deep <sup>(2)</sup>

**Notes:**

(1) Also available as part of 'Wireless Controls Pack' - see page 61.

(2) 80mm depth is with spacer for use with high insulation cylinder.

(3) Ensure there are no large metal objects between thermostat and receiver as these will interfere with radio signal.

(4) Clamp-on sensor should be fitted halfway down the DHW cylinder.

Receiver (RF model)	RX-1
Code No.	087N747600
Single zone receiver	•
Power supply	230 Vac, ±15%, 50/60 Hz
Contact details	1 x SPDT
Contact rating	10-230 Vac, 3 (1) A
Dimensions (mm)	138 wide x 88 high x 32 deep



# Heat/Cool Programmable Thermostats 6000 Series



HC6111-3

**A heat/cool fan-coil thermostat, ideal for use in commercial buildings where different programmes are required for weekends.**

The 6000 series of heat/cool thermostats are designed for use in 4-pipe fan coil unit systems where changeover from heat to cool is based upon the temperature within the room that the thermostat is controlling.

The thermostats provide sequenced control of heating and cooling stages dependent upon the room temperature. Unlike most heat/cool thermostats, which operate with a fixed dead-band between heating and cooling, the HC6000 products utilise a dual set point allowing the heating and cooling set points to be set completely independently of each other. An installer set minimum dead-band setting ensures that the heating and cooling setting cannot overlap.

These models combine the functionality of a timer and a thermostat into an easy to use 5/2 day unit that provides either two or four time and temperature events each day.

All products incorporate a fan output. This can be programmed to turn on and off with the demand for heat or cool, or can be set to run continuously. An enhanced fan mode allows the fan to run continuously during the day time periods but to turn on during unoccupied periods only where there is a demand. A manual 3-speed fan selector is built in to each product.

The range includes battery and mains powered units available with built-in or remote temperature sensors. All models incorporate an electronic lock to prevent unauthorised adjustment of programming. The same feature also allows the installer to limit the amount of user override features available.

**Additional Information:**

Wiring Information p. 73

- Available in battery and 230 volt versions
- Available in built-in and remote temperature sensing versions
- 5/2 day programming
- 2 or 4 time and temperature changes per day
- Large, easy to read LCD display
- Multi-function fan controls

Thermostat Function	Battery Powered Models		230V Powered Models	
	Type	Code No.	Type	Code No.
1 heat or 1 cool with manual changeover from heat to cool. (3 speed fan)	HCM6110-3	087N706000	HCM6113-3	087N705600
1 heat or 1 cool with water temperature changeover from heat to cool. Pipe sensor included (3 speed fan)	HCW6110-3	087N706100	HCW6113-3	087N706600
1 heat or 1 cool with auto changeover from heat to cool (3 speed fan) (Built-in Sensor)	HC6110-3	087N705300	HC6113-3	087N705700
1 heat or 1 cool with auto changeover from heat to cool (3 speed fan) (Remote Sensor)	HC6110A-3	087N710300	HC6113A-3	087N710100

Specification		
Power supply:	Battery powered models 230V powered models	2 x AA/LR6/MN1500 alkaline batteries 230V, ±15%, 50/60Hz
Temperature range		Heating stage 5-30°C and off Cooling stage 16-37°C and off
Temperature accuracy		± 0.5°C
Timing accuracy		± 1 minute
Thermal differential		<1°C
Deadzone adjustment		1, 2, 3 or 4°C
Voltage rating of contacts		20-250 Vac, 50/60Hz
Current rating of contacts		10mA - 3A resistive, 1A inductive
Switching action		Voltage free SPDT contacts, Type 1B
Output relay		3 (1) A
Memory retention	230V powered models Battery powered models	15 days 1 minute for battery change
Dimensions (mm)		130 wide x 100 high x 37 deep

The HC6000 models have a range of advanced options available to the installer at the time of commissioning.

Option	Description	Models	Factory Setting	Installer Options
1	Keyboard disable	All	Keyboard enabled	Keyboard disabled
2	Compressor delay timer	All	2 minutes	3, 4 or 5 minutes
3	Fan run-on after cooling timer	All	Off	30, 60 or 90 seconds
4	Heat/Cool dead band setting	All	2°C	1, 2, 3 or 4°C
5	Thermostat calibration offset	All	0	± 3°C

# Room Thermostats with Setting Dial

## RMT and RET

Providing accurate and reliable temperature control for a wide range of applications, from radiator based heating applications to underfloor heating.

### RMT Electro-Mechanical Room Thermostats

A stylish range of electro-mechanical room thermostats for use in 24V and 230V systems. All models, with the exception of RMT230\*, have an accelerator heater to improve control accuracy. Models are available with thermometer and night set-back facility, activated by an external time control.

### RET Electronic Room Thermostats

To complement the electro-mechanical models Danfoss produce a range of electronic room thermostats, which have a matching style to that of the RMT. The RET range is based upon a wallplate construction, allowing for ease of installation.

The RET range of electronic thermostats are available in 24V and 230V versions. All models incorporate an electronic anticipator heater to improve thermal performance. The thermostats are available in various configurations, including versions with voltage free contacts and LED status indication.

Included in the range are two special night set-back thermostats, which, by means of an external time clock, can be used to control overnight temperatures at a level 5K below normal day operation.

All RET24 and RET230 thermostats require a live and neutral power supply of the appropriate voltage.

### Additional Information:

Wiring Information p. 72



- Available in electronic and electro-mechanical models
- Electronic versions available with LED status indicators
- Models available for 24V and 230V operation
- Large, easy to read scale
- Locking and limiting as standard

RMT Electro-Mechanical Room Thermostats						
Type	Code No.	Operating Voltage	Built-in Thermometer	5K Night Set-back <sup>(1)</sup>	Switch Type	Comments
RMT230*	087N111000	230 Vac			SPDT	no accelerator
RMT230	087N110000	230 Vac			SPDT	
RMT230T	087N112500	230 Vac	•	•	SPDT	
RMT24	087N119600	24 Vac			SPDT	
RMT24T	087N119700	24 Vac	•	•	SPDT	

<sup>(1)</sup> Night set-back is achieved using external time control.

RET Electronic Room Thermostats						
Type	Code No.	Operating Voltage	LED Status Indicators		Switch Type	Comments
			Power on <sup>(1)</sup>	Stat Calling <sup>(2)</sup>		
RET230P	087N743000	230 Vac			SPDT	Volt-free contacts
RET230	087N700400	230 Vac		•	SPDT	
RET230L	087N700600	230 Vac	•	•	SPDT	
RET230VF2	087N700801	230 Vac	•	•	SPDT	Volt-free contacts
RET230NSB	087N701000	230 Vac	•	•	SPDT	5K night set-back volt-free contacts <sup>(3)(4)</sup>
RET24	087N701400	24 Vac		•	SPDT	
RET24VF	087N701600	24 Vac		•	SPDT	Volt-free contacts
RET24NSB	087N701800	24 Vac		•	SPDT	5K night set-back volt-free contacts <sup>(4)(5)</sup>

<sup>(1)</sup> Power on indicator is lit when power is applied to thermostat.

<sup>(2)</sup> Calling indicator is lit when thermostat relay is energised and calling for heat.

<sup>(3)</sup> In night set-back version, power on LED changes colour during night set-back period.

<sup>(4)</sup> Night set-back is achieved by using external time control.

<sup>(5)</sup> Second LED is lit during night set-back periods.

Specifications	RMT24	RMT230	RET24	RET230
Switching differential	<1°C	<1°C	<1°C	<1°C
Operating voltage (±15%)	24 Vac	230 Vac	24 Vac	230 Vac
Contact rating	10 (4) A	10 (4) A	3 (1) A	3 (1) A
Temperature	8-30°C	8-30°C	5-30°C	5-30°C
Dimensions	Wide	80mm	85mm	85mm
	High	80mm	80mm	86mm
	Deep	40mm	40mm	42mm

# Battery Powered Room Thermostat with Setting Dial

## RET-B



RET B



RET B-LS



RX1

*Traditional room thermostat with added functionality; ideal for upgrades where conventional two wire electro-mechanical thermostats are being replaced.*

RET-B is a battery powered room thermostat that offers the advantage of an easy to use setting dial plus the convenience of an LCD to display temperature.

Available in hard-wired and wireless models, the RET-B is an ideal product in the upgrade and replacement market since it only requires a two-wire connection.

Styled upon the RMT and RET room thermostat range, RET-B provides accurate electronic temperature control without the need for an external power supply. The design utilises a micro-processor which, as well as providing accurate temperature control, also drives a small LCD display which, during normal operation, displays actual room temperature and which changes briefly, to show setting temperature, whenever the setting dial is moved.

The micro-processor design also brings with it many sophisticated functions not normally found within such a thermostat. These include optional chrono-proportional regulation and cycle rate adjustment, heat or cool operation, compressor delay timer if cooling operation is selected and Fahrenheit or Centigrade temperature scale.

**Additional Information:**  
Wiring Information p. 72

- **Modern stylish design**
- **Electronic accuracy**
- **Large, easy to use setting dial**
- **LCD displays set temperature and actual temperature**
- **Battery driven**
- **Wallplate construction for ease of installation**
- **Chrono-proportional or On/Off Control**

Hard-wired Versions	RET B	RET B-LS
Code No. - hard-wired models	087N725100	087N725500
Wireless Versions	RET B-RF	RET B-LS-RF
Code No. - without receiver	087N727000	087N727200
Code No. - for set c/w single channel receiver	087N727600	
Auto/Off Selector Switch		•
Temperature range	5-30°C	
Setting dial and LCD display	•	
Chrono-proportional or on/off control	•	
Heat or cool operation, inc. compressor time delay	• <sup>(1)</sup>	
Selectable Fahrenheit or Centigrade scaling	•	
Low battery indicator	•	
Output relay contact rating (hard-wired models only)	10-250 Vac, 50/60 Hz, 3 (1) A	
Switching action (hard-wired models only)	1 x SPDT	
Transmitter frequency (wireless models only)	433.92 MHz	
Transmitter range (wireless models only)	Typically 30 metres line of sight <sup>(2)</sup>	
Power supply	2 x AA/LR6/MN1500 alkaline batteries	
Maximum ambient temperature	45°C	
Dimensions (mm)	85 wide x 86 high x 42 deep	

**Notes:**

(1) Compressor delay only available if thermostat is set to cool operation.

(2) Ensure there are no large metal objects between the thermostat and receiver as this will interfere with radio signal.

Receivers (RF models)	RX-1	RX-2	RX-2C	RX-3
Code No.	087N747600	087N747700	087N747900	087N747800
Number of zones	1	2	2	3
Power supply (receivers)	230 Vac, ±15%, 50/60 Hz			
Contact details	1-SPDT	1-SPDT, 1-SPST	2-SPDT	1-SPDT, 2-SPST
Contact rating	10-230 Vac, 3(1)A			
Dimensions (mm)	138 wide x 88 high x 32 deep			

# Room Thermostats with Delay Start RET-M and RET-MD

**Intelligent room thermostats with added functionality, including chrono-proportional control and delay start feature.**

RET-MD thermostats combine the ease of use benefits of a setting dial together with the accuracy and advanced features, including LCD display, that are only available from micro-processor based controllers. The LCD display, that normally shows actual room temperature, changes momentarily to show set temperature whenever the setting dial is moved. Styled upon the RET room thermostat, the RET-MD can be set up by the installer to provide either traditional on/off control or more sophisticated chrono-proportional control for increased comfort and economy.

The RET-MD is an intelligent room thermostat that incorporates an energy saving delay start feature, which delays the start-up of the heating dependent upon how close to set-point the room temperature is at the time the central heating time switch is scheduled to turn on the heating system. Under most load conditions, this feature reduces the number of hours per day that the system runs, without creating any discomfort. This feature can, if necessary, be cancelled if the user wishes to override the delay period.

A version without delayed start, type RET-M, is also available. This model offers all the features of the RET-B but is mains powered.

Both models are ideal for use with combination boilers and can be installed without the need for complicated wiring or commissioning.

**Additional Information:**

Wiring Information p. 72



RET-M



RET-MD

- **Intelligent heating control for increased fuel economy**
- **Micro-processor accuracy**
- **Setting dial with LCD temperature display**
- **Wallplate construction for ease of installation**
- **Chrono-proportional or On/Off Control**

Features	RET-MD	RET-M
Code No.	087N726200	087N726400
Temperature Range	5-30°C	
Setting dial and LCD display	•	
Delay start feature dependent upon proximity to set-point	•	
Delay start override button	•	
LED status indicators	•	
Chrono-proportional or on/off control	•	
Heat or cool operation, including compressor delay timer		• <sup>(1)</sup>
Selectable Fahrenheit or Centigrade scaling	•	
Delay start select/disable feature	•	
Output relay contact rating	10-250 Vac, 50/60 Hz, 3 (1) A	
Switching action	1 SPDT	
Power supply	230 Vac, ±15%, 50/60 Hz	
Maximum ambient temperature	45°C	
Dimensions (mm)	85 wide x 86 high x 42 high	
<i>Note:</i>		
<i>(1) Compressor delay only available if thermostat is set to cool operation.</i>		



# Room Thermostats with Function Switches

## RET230



RET230-C03



RET230-C3

- **Stylish, modern design**
- **Large easy to read setting dial**
- **Wide range - covers most applications**
- **Locking and limiting as standard**

**Suitable for the commercial heating and air conditioning market.**

All models in the range feature up to two supplementary switches, the functions of which vary between models. Most models incorporate a separate fan output terminal making them ideal for use in fan coil unit systems.

**RET230 C01** - For use in 2-pipe or 4-pipe systems. One switch provides manual Heat/Cool selection; a second switch provides Fan Auto/Continuous and system off selection.

**RET230 C02** - For use in 2-pipe or 4-pipe systems. One switch provides manual Heat/Cool selection; a second switch provides system Auto/Off selection.

**RET230 C03** - For use in 2-pipe changeover systems. One switch provides manual Heat/Off/Cool selection; a second switch provides 3-speed fan selection.

**RET230 C04** - As per RET230-C03 except Heat/Off/Cool switch is labelled with text as opposed to symbols.

**RET230 H3** - For use in heating systems. One switch provides Fan/Auto/Continuous and system off selection; a second switch provides 3-speed fan selection.

**RET230 C3** - For use in cooling systems. One switch provides Fan Auto/Continuous and system off selection; a second switch provides 3-speed fan selection.

**RET230 C32** - For use in cooling systems. One switch provides system Off/Auto selection; a second switch provides 3-speed fan selection.

**RET230 LS** - For use in heating or cooling systems. A manual switch is provided for Off/Auto selection.

**Additional Information:**

Wiring Information p. 73

	RET230-C01	RET230-C02	RET230-C03	RET230-C04
<b>Code No.</b>	087N702100	087N702200	087N703200	087N73400
Thermostat with manual heat/cool selection	•	•	•	•
Fan/Auto/Continuous switch with system Off selector	•			
System Off/Auto Selector		•		
Heat/Cool/Off (Winter/Off/Summer) selector			• <sup>1)</sup>	• <sup>2)</sup>
Heat/Cool (Winter/Summer) selector	•	•		
3-speed fan switch			•	•
Single speed fan output	•	•		
1) Switch label based on symbols				
2) Switch label based upon text				
	RET230-H3	RET230-C3	RET230-C32	RET230-LS <sup>3) 4)</sup>
<b>Code No.</b>	087N702400	087N702300	087N702700	087N700700
Heating thermostat	•			
Cooling thermostat		•	•	
Heating or cooling thermostat				•
Fan Auto/Continuous switch with system off selector	•	•		
System Off/Auto selector			•	•
Power on and thermostat calling LEDs	•	•	•	•
3-speed fan switch	•	•	•	
3) RET230-LS has SPDT contacts and can be used in heating or cooling systems				
4) RET230-LS2 has an additional voltage free manual switch, order code number 087N700900				
<b>Specification</b>				
Switching differential		<1°C		
Operating voltage		230 Vac, ±15%, 50/60 Hz		
Switch rating		2 (1) A		
Temperature range		5-30°C		
Dimensions (mm)		85 wide x 86 high x 42 deep		

(24V models are available on request)

# Flush Mounted Room Thermostat FlatStat FMT230D

**Stylish, flush mount room thermostat with LED output indicator and chrono-proportional control option.**

Unique in the Danfoss range of thermostats, the low-profile, flush mounted design of the FMT230D blends in seamlessly with existing electrical fittings such as light switches and electrical outlets. Fitted into a standard single gang UK electrical accessory box, the thermostat has an installed profile of just 16mm.

This newly designed flush thermostat combines the ease of use benefits of an easy to set dial, with a simple to read LCD display to provide accurate temperature control in all situations. The LCD display, that normally shows current room temperature, momentarily changes to show the required set temperature whenever the dial is turned. An LED light to indicate power supply, and another LED light to indicate when the output is active makes checking whether the heating is on straight forward. A simple indication of either a flame or a snowflake(\*) on the LCD provides visual confirmation of which operating mode as been selected.

The FMT230D allows selection of traditional on/off control, or advanced chono-proportional control. By using the chono-proportional control method, compared to standard electronic on/off control, energy and carbon emission savings of over 10% are achievable.

Options for setting up the thermostat are selected at time of installation by easy to set switches on the rear of the unit allowing selection of heating/cooling modes, on/off or chono-proportional control and 3/6/9/12 cycles for chono-proportional control.

(\*) If cooling mode has been selected

**Additional Information:**  
Wiring Information p. 72



FMT230D

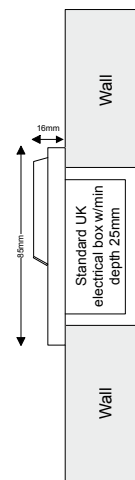

- **Modern stylish design**
- **Intelligent heating control for increased fuel economy**
- **Setting dial with LCD temperature display**
- **Micro-processor accuracy**
- **Low profile flush mounted style**
- **LED power and output indicator**
- **Chrono-proportional or On/Off Control**

Features	FMT230D
Code No.	087N774400
Temperature Range	5-30°C
Setting dial and LCD display	•
Chrono-proportional or on/off control	•
Heat or cool operation	•
Output relay contact rating	10-250 Vac, 50/60 Hz, 3 (1) A
Switching action	1 SPDT
Power supply	230 Vac, ± 15%, 50/60 Hz
Maximum ambient temperature	45°C
Dimensions (mm)	85 wide x 85 high x 35 deep

# Heat/Cool Room Thermostat RET230 HC and RET230 HCW



RET230 HC3



RET230 HCW3

- **Stylish modern design**
- **For use in 2-pipe or 4-pipe fan-coil systems**
- **230 volt operation**
- **Large setting dial with LCD temperature display**
- **On/Off or chrono-proportional regulation**

**Flexible, versatile heat/cool room thermostats with many enhanced features.**

The RET230 HC3 and RET230 HCW3 are a range of heat/cool room thermostats designed for use in either a 2-pipe or 4-pipe fan-coil systems. These flexible and versatile thermostats incorporate many enhanced features.

These thermostats feature an analogue setting dial, scaled 1 to 5, plus a small LCD display which normally displays actual room temperature, but changes momentarily to show the set temperature when the setting dial is moved.

In addition to the heating and cooling outputs, the thermostats incorporate a fan relay to control the operation of a single phase 3-speed fan motor. A manual switch on the right of the thermostat allows the user to manually select the required fan speed. An additional manual switch on the left allows the user to turn off the thermostat and to select whether the fan is switched on or off with the heating/cooling output or runs continuously. LED indicators provide clear indication of output status.

In addition to providing conventional on/off control, the thermostat can be set up at time of installation to provide chrono-proportional output. This type of control mode provides closer control accuracy compared to on/off control.

### RET230 HC Range

The RET230 HC range is designed for use in 4-pipe fan-coil unit systems, split packaged systems and in air to air heat-pump systems.

### RET230 HCW

The RET230 HCW is designed for use in 2-pipe fan coil unit systems with central changeover between heating and cooling.

### Additional Information:

Wiring Information p. 74

		4-Pipe Systems		2-Pipe Systems	
		1-Speed Fan	3-Speed Fan	1-Speed Fan	3-Speed Fan
Built-in sensor		RET230 HC1 087N780300	RET230 HC3 087N780500	RET230 HCW1 087N780700	RET230 HCW3 087N780800
Remote sensor		RET230 HCA1 087N780400	RET230 HCA3 087N780600		
Temperature Range - Heating		5-30°C			
Temperature Range - Cooling		7-32°C at dead-band of 2K			
Temperature Range - Cooling		9-34°C at dead-band of 4K			
Selectable dead-band		2 or 4K			
Changeover Temperature	Cool to heat Heat to cool			Pipe temperature >30°C Pipe temperature <16°C	
Thermal differential in on/off mode		<1°C			
Temperature Accuracy		±1°C			
Pipe sensor for heat/cool changeover				•	
Thermostat off/auto & fan on selector		•			
LCD display of set/room temperature		•			
Heat/cool output status LED		•			
Power on/fan output status LED		•			
On/Off or Chrono-proportional control		•			
Optional compressor delay timer		•			
Fan-coil or heat-pump configuration		•			
Reversing valve heat or cool selection <sup>1)</sup>		•			
Selectable Celsius or Fahrenheit scaling		•			
Maximum ambient temperature		45°C			
Power supply		230 Vac, ±15%, 50/60 Hz			
Relay outputs, heat, cool and fan		3 x SPST, 3(1)A, 10-230 Vac		2 x SPST, 3(1)A, 10-230 Vac	
Dimensions (mm)		110 wide x 90 high x 40 deep			
Note					
1) Reversing valve function is only available if set up for heat-pump operation.					

(24V models are available on request)

# For use with OpenTherm Boilers

## ORT Modulating Thermostat

OpenTherm technology allows a thermostat to control a boiler more precisely, achieving more accurate room temperature control and reducing energy consumed. A traditional room thermostat controls the temperature by switching a relay that turns the heating on or off. An OpenTherm system allows the thermostat to control the room temperature by telling the boiler to modulate the boiler flame. Rather than using a relay, an OpenTherm thermostat “talks” to the boiler via a simple low voltage two-wire connection.

The OpenTherm Association have agreed a standard so that all OpenTherm products are guaranteed to work with any OpenTherm Boiler. Tests undertaken show that energy used to maintain a room at 20°C are significantly less using a modulating OpenTherm thermostat over a conventional electronic thermostat when combined with an OpenTherm boiler. One reason is that an OpenTherm boiler with a modulating control spends longer in condensing mode by keeping the return temperature lower.

The ORT room thermostats provide modulating control of OpenTherm equipped condensing gas boilers. This type of control ensures that the flow temperature from the boiler is modulated down to as low a level as prevailing load permits, thus significantly increasing the proportion of the boiler operating time that is spent in condensing mode. These thermostats are fully compliant with OpenTherm communications protocol including low load regulation and domestic hot water keep hot feature now in common use in many combination boilers.

The ORT-01 has a setting dial and status LED indicator providing information on boiler output. The ORT-10 benefits from a LCD display showing current temperature and a button to switch off the hot water store for energy saving.

**Additional Information:**  
Wiring Information p. 72



ORT-01



ORT-10

- **Suitable for use with any OpenTherm boiler**
- **Provides direct modulation of boiler**
- **Significantly improves boiler efficiency**
- **Accurate room temperature control**
- **Easy to understand interface**

Features	ORT-01	ORT-10
Code Number	087N774300	087N773800
Temperature range	8-30°C	
Maximum ambient temperature	45°C	
Control type	P + I	
OpenTherm software version	2.3	
LCD Display		•
Domestic hot water keep hot feature		•
Domestic hot water off feature (holiday mode)		•
Hot water store switch off function		•
ID 14 low load control		•
Thermostat output	Data	
Construction	EN60730-2-9	
IP rating	IP20	
Supply voltage	24V DC from boiler	
Wiring, non-polarised 2 wire bus		•





# Cylinder, Pipe and Frost Thermostats ATC, ATP, ATF, RET230F and CET B-RF



ATC

ATF

CET B-RF with CS1 sensor

### ATC Cylinder Thermostat

The ATC is an electro-mechanical surface mounting cylinder thermostat, which is clamped to the cylinder wall by means of a spring clamping band.

### ATP Pipe Thermostat

The ATP is an electro-mechanical surface mounting pipe thermostat, which can be clamped onto steel or copper pipes which have a diameter of between ½" (15mm) and 2" (50mm). Typical applications include return temperature control in oil-fired systems.

### RET 230F Room Frost Thermostat

The RET 230F is an electronic room mounting frost thermostat with an adjustable range of 5-10°C. Once set the thermostat can be locked and limited to the desired value.

### RET 230F5 Room Frost Thermostat

For situations where a fixed setting frost thermostat is required, the RET 230F5 is available and is factory set to 5°C.

### ATF Pipe Frost Thermostat

The ATF is an electro-mechanical surface mounting pipe thermostat for use in frost protection applications. It can be clamped onto steel or copper pipes which have a diameter of between ½" (15mm) and 2" (50mm).

### CET B-RF wireless cylinder thermostat

Ideal for applications where it is difficult to wire between the cylinder and the control valve or boiler. A clamp-on sensor, which is hard-wired to the CET B-RF thermostat, measures the stored temperature. Requests for heat are transmitted using secure digital FM radio signals to an RX receiver unit mounted adjacent to the boiler or control valve. Time control is provided using a programmer or timeswitch mounted adjacent to the receiver unit.

RET230 frost thermostats require a 230 Vac live and neutral supply to operate.

### Additional Information:

Wiring Information p. 75

- Wide range of electro-mechanical and electronic thermostats
- For cylinder, pipe and frost protection applications
- Range includes hard-wired and wireless cylinder thermostats

AT Cylinder and Pipe Thermostats - Hard Wired						
Type	Code No.	Temp. Range °C	Switching Differential	Switch Type	Switch Rating	Comments
ATC Cylinder	041E001000	30-90	8 ±3°C	SPDT	6 (2) A	c/w fixing strap
ATP Pipe	041E000000	30-90	6-10°C	SPDT	6 (2) A	c/w fixing strap
Frost Thermostats - Room						
RET230F	087N701200	5-10	<1°C	SPST	3 (1) A	Requires 230V live and neutral
RET230F5	087N701300	5 (fixed)	<1°C	SPST	3 (1) A	Requires 230V live and neutral
Frost Thermostats - Pipe						
ATF	087N671200	10-90	8°C	SPDT	6 (2) A	c/w fixing strap

Note: All thermostats are suitable for 230V operation.

Wireless Cylinder Thermostat with Setting Dial	CET B-RF
Code No. (without receiver)	087N727700
Code No. (with single channel receiver RX-1)	087N727800
Temperature range	40-65°C
Switching differential	6K
Clamp-on temperature sensor	.
Transmitter frequency	433.92 MHz
Transmitter range	30 metres line of sight <sup>(1)</sup>
Power supply	2 x AA/LR6/MN1500 alkaline batteries
Maximum ambient temperature (setting module)	45°C
Dimensions, setting module (mm)	85 wide x 86 high x 42 deep
Dimensions, clamp-on sensor (mm) <sup>(2)</sup>	48 wide x 48 high x 45 (or 80) deep

Notes: (1) Ensure no large metal objects are between thermostat and receiver as these will interfere with radio signal. (2) 80mm depth is with spacer for use with high insulation cylinder.

Receiver (RF model)	RX-1
Code No.	087N747600
Single zone receiver	.
Power supply	230 Vac, ±15%, 50/60 Hz
Contact details	1 x SPDT
Contact rating	10-230 Vac, 3 (1) A
Dimensions (mm)	138 wide x 88 high x 32 deep

# Immersion Thermostats ITC, ITL and ITD

Used for control and limitation of water temperature in the hot water cylinder and other applications requiring immersion thermostats.

## ITC 100 Immersion Control Thermostat

The ITC 100 is an immersion thermostat having a 100mm insertion length. The thermostat, which is supplied with a ½" BSP/100mm pocket, is suitable for the control of applications which require accurate immersion sensing, e.g. unvented hot water systems.

The thermostat, which has an adjustment range of 0-90°C, has SPDT contacts making it suitable for the control of all types of motorised valves.

A tamperproof version with concealed setting dial is also available.

## ITL 100 Immersion Limit Thermostat

The ITL 100 is an immersion limit thermostat having an insertion length of 117mm.

The thermostat which is supplied with a ½" BSP/117mm pocket is suitable for applications which demand an immersion thermostat offering manual re-set facility.

The thermostat is factory pre-set to 90°C and has SPST contacts.

## ITD 100 Immersion Dual Control and Limit Thermostat

The ITD 100 is an immersion thermostat which incorporates a separate limit and control function.

The control function set point can be varied between 0°C and 90°C. The limit function, which requires manual re-setting after activation, is factory pre-set to 80° or 90°C, dependent on code number when ordered.

The thermostat is supplied with a 1/2" BSP/100mm pocket.

### Additional Information:

Wiring Information p. 75



ITC and ITC Tamperproof

ITL and ITD

- Suitable for use with any OpenTherm boiler
- Provides direct modulation of boiler
- Significantly improves boiler efficiency
- Accurate room temperature control
- Easy to understand interface

Specifications	ITC Control Thermostat	ITC Control Thermostat	ITL Limit Thermostat	ITD Dual Thermostat	ITD Dual Thermostat
Code No.	099-105700	099-105800	099-105900	099-106100	099-106200
Control Function (thermal re-set)	•			•	•
Control Function (thermal re-set) with concealed, tamper-proof adjustment		•		•	•
Limit function (manual re-set)			•	•	•
Dual control and limit function				•	•
Temperature range (Control)	0-90°C	0-90°C		0-90°C	0-90°C
Temperature range (Limit)			90-110°C	90-110°C	90-110°C
Limit temperature factory setting			90°C	90°C	80°C
Switching differential	4 ± 1K	4 ± 1K		4 ± 1K	4 ± 1K
Switch configuration - Control	SPDT	SPDT		SPDT	SPDT
Switch configuration - Limit			SPST	SPST	SPST
Switch voltage rating	10-240 Vac, 50/60 Hz				
Switch current rating	10 (2.5) A				
Max. ambient temperature (Switch Head)	65°C	65°C	80°C	80°C	80°C
Maximum Temperature (Medium)	150°C				
Pocket dimensions (mm) (all have ½" BSP connections)	100	100	120	100	100
Dimensions - thermostat head - wide	54mm	54mm	54mm	100mm	100mm
Dimensions - thermostat head - high	110mm	110mm	110mm	110mm	110mm
Dimensions - thermostat head - deep	55.5mm	55.5mm	56.5mm	56.5mm	56.5mm

# Chrono-Proportional Load Compensator Control Technology

Reducing energy costs and carbon emissions is achievable through fitting chrono-proportional controls.

Chrono-proportional control is a load compensator as it ensures that the boiler 'on' time is reduced to a minimum and matches the boiler heat output with the heat loss. This reduces the net temperature of the return water to the boiler.

If a property only has a simple mechanical thermostat installed, then the energy-saving benefits of a replacement high-efficiency condensing boiler will not be realised as the boiler will rarely be running in condensing mode.

Switching to an on/off electronic room thermostat produces reductions of over 2% in both energy cost and carbon emissions.

The use of an electronic thermostat with chrono-proportional capability provides closer temperature control plus possible reductions of 10% in both fuel cost and carbon emissions.

These results are from tests using Danfoss controls. Tests carried out with other manufacturers' on/off controls produced similar figures.

### Conclusions

Changing the boiler alone from non-condensing to condensing in a domestic central heating system will not necessarily optimise potential energy and carbon emission savings.

An electronic room temperature control, preferably with chrono-proportional capability, is often needed to make the cost of replacing the boiler worthwhile.



RT51 and TP4000



TP5000 Si and TP7000



TP9000



RET B and RET B-LS



RET M and RET MD



FlatStat

**Impact of Control Technology on Condensing Boilers**  
*Standard A-Rated Condensing Boiler*

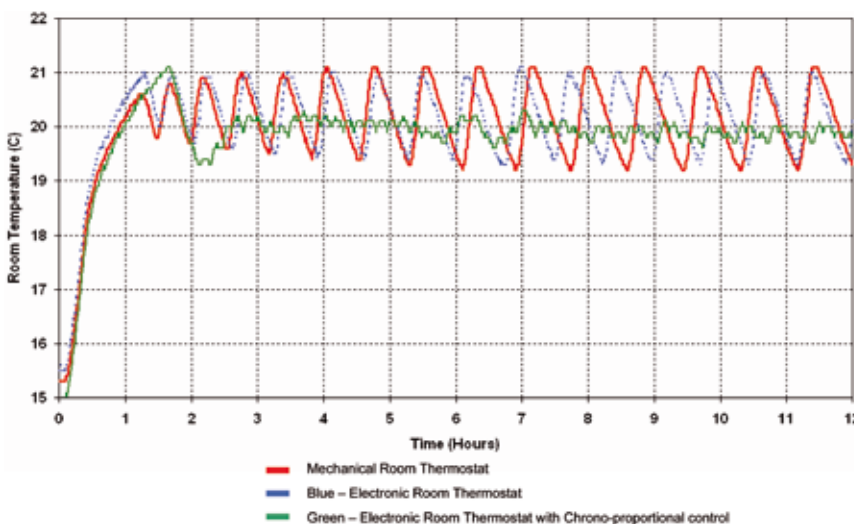

Control	Energy Cost (£)	Energy Saving (%)	Carbon Emissions (kg CO <sup>2</sup> )	Carbon Saving (%)
Mechanical On/Off	2.39	-	13.56	-
Electronic On/Off	2.34	2.10	13.25	2.31
Chrono-Proportional	2.14	10.35	12.11	10.71

# Underfloor Heating Controls Product Selector

<b>Electric Underfloor Warming: Floor Warming Mats</b>				
Concrete floors	Timber floors	Timber or carpet floors	Electronic Thermostats	Page
			Hard-wired, 230 volt Programmable	
Devimat 150	Devimat 100		Devireg 550	<b>50</b>
Devimat 200			Devireg 130	<b>50</b>
		Devidry 55		<b>52</b>
		Devidry 100		<b>52</b>

<b>Water Based Underfloor Heating: Hard-wired Multi-zone Solutions</b>							
Wiring Centre	Room Thermostats				Time Control		Page
	Electronic			Electro-mechanical	Electronic		
	Programmable	Setback	Standard		Standard	1-channel	
FH-WC							<b>54</b>
	TP5000 Si						<b>54 &amp; 31</b>
	TP7000						<b>54 &amp; 32</b>
		RET230NSB	RET230	RMT230			<b>54 &amp; 38</b>
				RMT 230T			<b>54 &amp; 38</b>
					TS715 Si	FP975-2H	<b>54 &amp; 22</b>

*Note: 8 zone hard-wired box can control up to 8 zones of floor heating. Boiler and pump control is by 2 SPST voltage free relays within the box.*

<b>Water Based Underfloor Heating: Wireless Multi-zone Solutions</b>					
Wiring Centre	Electronic Room Thermostat	Electronic Time Control		Accessories	Page
	Setback	1-channel	2-channel		
		TS715 Si	FP975-2H		<b>54 &amp; 22</b>
FH-BU*					<b>55</b>
	FH-RT				<b>55</b>
CF-MC (5 Outputs)	CF-RS			CF-RC	<b>53</b>
CF-MC (10 Outputs)	CF-RP			CF-RU	<b>53</b>
	CF-RD				<b>53</b>
	CF-RF				<b>53</b>

*\* Note: Zone 7 and zone 8 outputs are normally assigned to boiler and pump control.*

<b>Other Floor Heating Controls</b>			
Self-acting floor heating thermostat	Manifolds, accessories & pipe fittings	Thermal actuators	Page
FHV-R			<b>57</b>
	FHF-F		<b>56</b>
	Pipe fittings		<b>19</b>
		TWA-A	<b>56 &amp; 66</b>



# Underfloor Heating and Warming

## *Luxurious Warm Floors*

<i>DeviMat</i> .....	50	<i>CF2</i> .....	53
Electric Underfloor Warming		2-Way Wireless Floor Heating Control System	
For timber or concrete based floors			
<i>DeviDry</i> .....	52	<i>FH-WC</i> .....	54
Electric Underfloor Warming		Hard Wired Zone Control	
For use under wood, laminates and carpet			
		<i>FH-BU</i> .....	55
		Wireless Zone Control	
		<i>FHF-F</i> .....	56
		Floor Heating Manifold	
		<i>FHV-R</i> .....	57
		Underfloor Heating Valve	

**For further information on underfloor heating and floor warming please see our dedicated selection guide for electrical floor warming or wet underfloor heating controls.**



# Electric Underfloor Warming DeviMat

**Ideal for floor heating requirements in bathrooms, kitchens or conservatories.**

DeviMat is a slimline electrically heated mat specifically designed for installation within the adhesive layer of floor tiles or other floor covering. The product is ideal for use in areas such as bathrooms, kitchens and conservatories in both new build and renovation situations. The system provides a cost effective method of providing warmed floors. Available in three versions, one for timber based floors and the other two for concrete based floor systems, DeviMat is easy to size and install.

The mat is prefabricated for easy installation and comprises a self adhesive open mesh onto which a thin heating cable is attached. The mat is laid onto the floor and is then covered by a flexible tile adhesive which is used to fix the tiles to the floor. Mats are available in a range of sizes from 0.5 m<sup>2</sup>-12 m<sup>2</sup>, each mat is approximately 0.5m wide.

For example, a 5m<sup>2</sup> mat is 10m long. To size, simply measure the area to be covered to determine the required area and choose from either the timber floor or concrete floor range. When installing, cut the mesh to turn the mat, taking care not to cut the heating cable, until the floor area is covered.

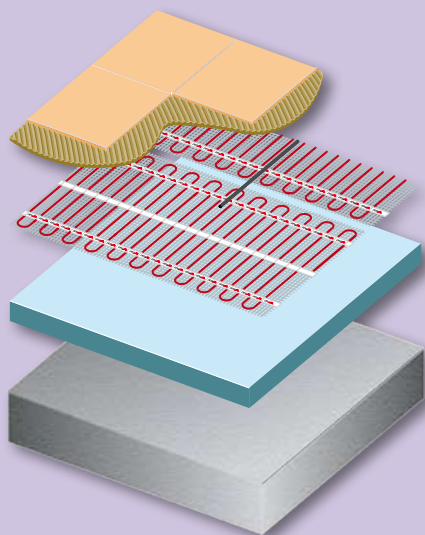

DeviMat Box



Devireg 550 Programmable Thermostats



Devireg 130 Thermostats

- **Luxury of a warm tiled floor**
- **Simple to install**
- **No significant increase in floor height**
- **Even heat across floor**
- **Dry floor removes the possibility of mould growth**
- **Ultra-thin mat, just 3.5mm deep**

Area (m <sup>2</sup> )	DeviMat DTIF-100 100W/m <sup>2</sup> for timber based floors		DeviMat DTIF-150 150W/m <sup>2</sup> for concrete based floors or insulated board	
	Heating Load (watts)	Product Code <sup>(1)</sup>	Heating Load (watts)	Product Code <sup>(1)</sup>
0.5	50	83030100	75	83030120
1.0	100	83030101	150	83030121
1.5	150	83030102	225	83030122
2.0	200	83030103	300	83030123
2.5	250	83030104	375	83030124
3.0	300	83030105	450	83030125
3.5	350	83030106	525	83030126
4.0	400	83030107	600	83030127
5.0	500	83030108	750	83030128
6.0	600	83030109	900	83030129
7.0	700	83030110	1050	83030130
8.0	800	83030111	1200	83030131
9.0	900	83030112	1350	83030132
10.0	1000	83030113	1500	83030133
12.0	1200	83030114	1800	83030134

Note:  
(1) comes complete with 4mm connection tail and 2m length of flexible conduit to accommodate floor sensor.

Area (m <sup>2</sup> )	DeviMat DTIF-200 200W/m <sup>2</sup> for concrete based floors or insulated board. (Only for tiles on top)	
	Heating Load (watts)	Product Code <sup>(1)</sup>
0.5	87	83020735
1.1	215	83020736
1.5	285	83020737
2.1	430	83020738
2.5	500	83020739
3.1	605	83020740
3.5	695	83020741
4.3	845	83020742
5.0	990	83020743
6.1	1210	83020744
7.0	1385	83020745
7.8	1565	83020746
8.8	1715	83020747
10.5	2070	83020748

Thermostat & Cable Monitor		
Feature	Code No	Type
Intelligent, 7 day programmable	19150101	Devireg 550 white
Intelligent, 7 day programmable	19150110	Devireg 550 silver
Simple, non programmable	19112012	Devireg 130 white
Cable Monitor	30953095	Deviguard

## Installation Information



1. The free area where the floor heating is to be fitted must be measured to determine which Devimat size is needed.



2. A groove is cut into the floor and wall approximately 10mm deep and wide for the floor sensor and tube. The tube allows for easy removal of floor sensor if required.



3. Before laying the self-adhesive mat, the floor should be clean and dry, primed if necessary. Once the mat has been tested, it is rolled out and laid on the floor.



4. On reaching the end of the mat run, simply cut the mesh, turn the mat and lay the next piece beside the first. The red heating cable must NOT be cut.



5. If required the mat can be fixed to the floor using tape on a timber floor or a glue gun on a concrete floor. With the mat in place the floor is ready to be covered.



6. The devimat can be covered by one layer of flexible tile adhesive/self-levelling compound and allowed to dry before tiling, or lay the tile adhesive and tiles in one operation. Always use flexible tile adhesive and grout.

## Application Information

### IMPORTANT:

Thermostat must be located outside of wet area in accordance with wiring regulations.

### Please note:

Danfoss recommends the use of insulated rigid cement based board under the Devimat to minimise heat loss and optimise heat output to floor surface.

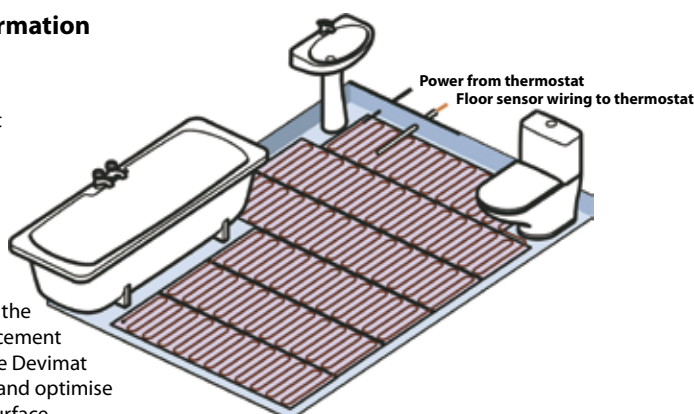

The mat utilises a twin-core heating cable with solid aluminium sleeve for added safety. Total thickness of the mat and cable is just 3.5mm. Termination of the mat to the thermostat is achieved using a single cable moulded onto the mat during manufacture.

Control is by an intelligent programmable thermostat, type Devireg 550, which is used to control the floor temperature. The 550 is a flush mounting thermostat which mounts into a standard 47mm deep single socket box. It comes complete with a floor sensor on a 2.5m cable. The thermostat can control up to 3600 Watts.

Alternatively, the Devireg® 130 is a basic thermostat which also uses a floor sensor to monitor the floor temperature, the difference being that this has no timer facility. The single dial on the 130 is used to control the temperature of the floor and also switches the system off.

A Deviguard cable monitor is available and can be connected to the heating mat during tile installation. The monitor measures circuit resistance raising an alarm if the heating cable is cut or damaged.

### Important Note

If the application is within a bathroom, the thermostat module must be located outside the bathroom in accordance with wiring regulations.

### Additional Information:

Wiring Information p. 76



# Electric Underfloor Warming DeviDry

*When floors in homes are renovated, comfort floor warming can be easily added without using screed and without breaking up the old floor.*

The DeviDry system is a unique 'click and plug' electric underfloor warming system designed to be used beneath wood, laminates and carpet flooring.

The system does not require any wiring or connection by an electrician; it simply connects to a power socket using a kit which consists of a current device and a wall mounted thermostat. To make it even easier to install, there is no need for any adhesive or screed between the heat source and the floor covering.

The DeviDry mat incorporates the underfloor warming system and a foam flooring underlay – which insulates acoustically, reducing noise between floors.

Each piece is fitted with a 'Click and Plug' connection system, so the system can be laid by simply clicking the mats together. To ensure an even floor surface, any awkward corners and areas around the edges can be filled with DeviDry filler material.

DeviDry is both comfortable and economical and is rated at 55 W/m<sup>2</sup> for installation onto timber and 100W/m<sup>2</sup> for installation onto concrete floors.

The system comes complete with a thermostat kit.

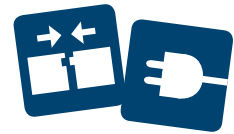
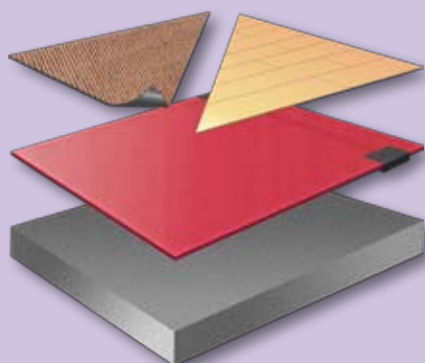

The Click & Plug System

- **Easy installation**
- **Fast responding floor heat**
- **Even heat distribution**
- **17dB sound reduction**
- **Low building height - 8mm**
- **No use of screed**
- **Easily removed**
- **5-year warranty**

DeviDry 55 For timber based floors			
Area (m <sup>2</sup> )	Heating Load (watts)	Heated Area	Product Code
1.0	22	0.4m <sup>2</sup>	89300000
2.0	77	1.4m <sup>2</sup>	89300002
3.0	132	2.4m <sup>2</sup>	89300004
4.0	187	3.4m <sup>2</sup>	89300006
5.0	242	4.4m <sup>2</sup>	89300008

DeviDry 100 For timber based floors			
Area (m <sup>2</sup> )	Heating Load (watts)	Heated Area	Product Code
1.0	40	0.4m <sup>2</sup>	89300020
2.0	140	1.4m <sup>2</sup>	89300022
3.0	240	2.4m <sup>2</sup>	89300024
4.0	340	3.4m <sup>2</sup>	89300026
5.0	440	4.4m <sup>2</sup>	89300028

Technical Details	
Height	8mm
Mains Voltage	230V (50Hz)
Max. Amps per DeviDry System	10A
IP Rating for DeviDry Element	IP x7
Output	55W/m <sup>2</sup> on wooden subfloors 100W/m <sup>2</sup> on concrete subfloors
Sound Reduction Valve	17 dB
Insulation Valve (U-Value)	8W/m <sup>2</sup> K

Control Packs and Accessories		
19911002	Control pack for the DeviDry 55 floor warming mat complete with wall mounted room thermostat, floor sensor, power unit with output cord and plug connection plus a mat connecting tool. Limited to control a maximum heated surface of 42m <sup>2</sup>	
19911003	Control pack for the DeviDry 100 floor warming mat complete with wall mounted room thermostat, floor sensor, power unit with output cord and plug connection plus a mat connecting tool. Limited to control a maximum heated surface of 23m <sup>2</sup>	
89300030	DeviDry FM1	Filler Material 1m <sup>2</sup>
89300031	DeviDry FM2	Filler Material 2m <sup>2</sup>
89300032	DeviDry FM4	Filler Material 4m <sup>2</sup>
19911110	DeviDry X25	Extension Cord 25cm
19911111	DeviDry X100	Extension Cord 100cm
19911112	DeviDry X200	Extension Cord 200cm
19405856	Devi tape 38mm x 50m	For fixing element

# 2-Way Wireless Floor Heating Control System

## CF2

**Wireless floor heating control system which offers unrivalled ease of installation and an extremely user-friendly approach to controlling hydronic floor heating.**

With a range of features for optimal comfort, the energy efficient CF2 system provides individual room or floor temperature control, with the option of wireless remote control.

In addition, the CF2 system has been developed to ensure installation, commissioning, and service is quick and easy for the heating installer. With no electrical installation of the thermostat necessary, the quick installation and easy commissioning saves installers time and reduces their costs.

The CF2 range consists of:

**Four wireless room thermostats**

**CF-RS** - Standard room thermostat with temperature setting dial.

**CF-RP** - Tamperproof room thermostat with no direct access to settings.

**CF-RD** - Display room thermostat with LCD which displays actual temperature or setting temperature.

**CF-RF** - Display and infra-red room thermostat with LCD which displays actual temperature or setting temperature and infrared floor sensor which measures floor surface temperature.

**CF-MC Master Controller**

Available with 5 or 10 outputs.

**CF-RU Repeater Unit**

Which extends the transmission range to the master controller from the room thermostats.

**CF-RC Remote Controller**

Wireless connection to all the CF2 components and offering a range of extended functions and features such as time control of individual room thermostats.

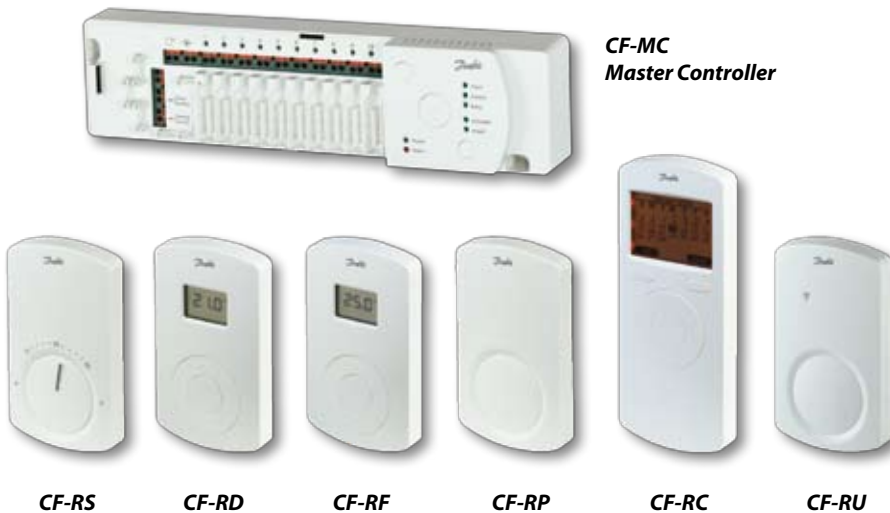

- Energy saving floor heating
- Individual room temperature control
- Easy wireless installation
- Safe and reliable 2-way wireless communication technology
- Possible temperature override by remote control

Master Controller	CF-MC Master Controller with 5 outputs	CF-MC Master Controller with 10 outputs
Code No.	<b>088U020501</b>	<b>088U020001</b>
Supply Voltage	230 V a.c.	
Output Voltage	24V dc	
Transmission Frequency	868.42MHz	
Transmission Range	Up to 30 metres	
Transmission Power	< 1mW	
Max. running load or actuator output	35VA in total for all outputs	
Max. load for pump relay	230V and 8A/2A (Inductive)	
Max. load for boiler relay	230V and 8A/2A (inductive)	

Wireless Room Thermostats	CF-RS Standard Wireless Room Thermostat	CF-RP Tamperproof Wireless Room Thermostat	CF-RD Display Wireless Room Thermostat	CF-RF Display & InfraRed Wireless Room Thermostat
Code No.	<b>088U021000</b>	<b>088U021100</b>	<b>088U021200</b>	<b>088U021300</b>
Supply Voltage	2 x 1.5V Alkaline Batteries AA			
Battery Life	CF-RS/P 3-4 years. CF-RD/F 1-2 years			
Transmission Frequency	868.42MHz			
Transmission Range	Up to 30 metres			
Transmission Power	< 1mW			
Temperature Setting Range	5-35°C			

Wireless Remote Controller	CF-RC
Code No.	<b>088U022001</b>
Supply Voltage	230 V a.c. and 2 x 1.5V Alkaline AA batteries
Transmission Frequency	868.42MHz
Transmission Range	Up to 30 metres
Transmission Power	< 1mW

Repeater Unit	CF-RU
Code No.	<b>088U023001</b>
Transmission Frequency	868.42MHz
Transmission Range	Up to 30 metres
Transmission Power	< 1mW



# Hard Wired Zone Control FH-WC

Whole house underfloor heating is supplied with warm water at a temperature of around 50°C either from a mixing circuit or from a low temperature condensing boiler. A network of embedded plastic pipes, connected to a distribution manifold, delivers the heat to the floors of the rooms. Individual room thermostats control the operation of thermal actuators mounted on the distribution manifold.

The FH-WC is an eight zone floor heating wiring centre for systems with hard wired room thermostats. In addition to providing a structured wiring system for zone thermostats and associated thermal actuators, the FH-WC also incorporates two voltage free heat demand relays that are activated when one or more zones call for heat. The two relay solution allows for separate control of a floor heating zone pump and a boiler. With this arrangement, the boiler may be used for normal radiator heating and hot water service provision, without the need for external relays.

### Time and temperature control options:

TS715Si, a single zone timeswitch, turns off the whole system at programmed times. If this system is adopted, room temperature control is achieved using RMT230 or RET230 room thermostats.

FP975-2H, a two-zone programmer with set-back, can be used. During installation, the installer can choose on a zone by zone basis the time channel to which the zone thermostat is connected. Special room thermostats with set-back feature, type RET230NSB, are used to lower the room temperature by 4°C during unoccupied periods.

Programmable zone temperatures are achieved by programmable room thermostats, such as TP5000 Si, located in each zone. This allows flexible time programming and freedom to choose different temperatures at different times of the day.

**Additional Information:**  
Wiring Information p. 76



- Incorporates separate boiler and pump interlocks
- Can be used with a wide range of thermostats
- Convenient and easy to wire floor heating connection box

Hard-wired Systems Wiring Box - FH-WC	
Code No	088H012801
Number of zones (thermostats in/thermal actuator zones out)	8
Time channels (requires external 1-channel or 2-channel time control)	2 <sup>(1)</sup>
Boiler interlock relay, (voltage free) <sup>(2)</sup>	SPST, 6(2)A
Pump interlock relay, (voltage free) <sup>(2)</sup>	SPST, 6(2)A
Supply voltage	230 Vac, ±15%, 50/60 Hz
Output voltage (to zone thermostats and thermal actuators)	Max 250 Vac
Output per channel	up to 0.5A
Dimensions (mm)	314 wide x 110 high x 81 deep
Available in 24 volt	088H001700
Notes:	
<sup>(1)</sup> One of two time channels can be assigned at time of installation to each thermostat.	
<sup>(2)</sup> Boiler and pump relays are activated whenever one or more zone thermostats call for heat.	

Thermostat and Time Control Compatibility Table	Time Controls		Room Thermostats	
	Product	Page	Product	Page
Simple single zone central time control	TS715 Si	22	RMT 230	40
			RET 230	40
Two-zone time control with local set-back	FP975-2H	23	RMT 230T	40
			RET 230NSB	40
Programmable time and temperature control of individual zones	Not required		TP5000 Si	33
			TP7000	34

# Wireless Zone Control FH-BU, FH-RT and UF-H



**FH-RT**



**TS715 Si**



**FP975-2H**



**FH-BU**



**UF-H Timer Interface**

- All models incorporate separate boiler and pump interlock circuits
- Convenient and easy to wire floor heating connection box

The FH-BU wireless thermostat system is a six-zone floor heating wiring centre for use in systems utilising wireless room thermostats. In addition to providing a structured wiring system for thermal actuators, the FH-BU also incorporates two voltage free heat demand relays that are activated when one or more zones call for heat. The two relay solution allows for separate control of a floor heating zone pump and a boiler. With this arrangement, the boiler may be used for normal radiator heating and hot water service provision, without the need for external relays.

FH-RT room thermostats are simple to use wireless room thermostats which communicate with the FH-BU receiver unit using secure digital RF communication. A manual selector switch allows the user to select between a daytime temperature as set on the thermostat setting dial or Auto. If Auto is selected the thermostat controls at the set temperature during normal day periods and at 5°C below set temperature during night periods. Time control of day and night periods is achieved centrally by a timer module built into the FH-BU receiver module.

In systems that require a common set back time, timed set back can be achieved using an UF-H timer interface card and a standard voltage free timeswitch. In systems where different times are required in selected zones a two channel timer with voltage free contacts must be used. If a two channel timer is used channel one is assigned to zones 1, 3 & 5, (plus 7 if pump control has not been assigned to it). Channel two is assigned to zones 2, 4 & 6, (plus 8 if boiler control has not been assigned to it).

The UF-H timer interface card is supplied as an accessory and is mounted inside the FH-BU front case by the installer. Details of suitable timers are shown in the table on page 54.

Wireless Systems - Wiring Box and RF Receiver	FH-BU
Code No.	088H011901
Number of zones (thermostats in/thermal actuator zones out)	6
Time channels (require FH-RN Timer Module)	2 <sup>(1)</sup>
Boiler interlock relay, (voltage free) <sup>(2)</sup>	SPST, 6(2)A
Pump interlock relay, (voltage free) <sup>(2)</sup>	SPST, 6(2)A
Supply voltage	230 Vac, ±15%, 50/60 Hz
Output voltage, (to thermal actuators)	Max 250 Vac
Output per channel	up to 0.5A
Receiver operating frequency	433.70MHz
Dimensions (mm)	314 wide x 110 high x 81 deep
Notes:	
(1) Channel 1: Zones 1, 3 & 5. Channel 2: Zones 2, 4 & 6.	
(2) Boiler and pump relays are activated whenever one or more zone thermostats call for heat.	
Wireless Thermostat Systems - Room Thermostat	FH-RT
Code No.	088H012101
Temperature range	5 - 30°C
Day/Night/Auto manual selector switch (set back = 5K)	.
Power supply	1 x AA size 3.6V Lithium cell
Transmitter operating frequency	433.70MHz
Transmitter range	100m line of sight
Dimensions (mm)	80 wide x 80 high x 30 deep
Timer Interface Module	UF-H
Code No	087N782000
Number of channels	2

**Additional Information:**  
Wiring Information p. 76

# Floor Heating Manifold

## FHF-F

The FHF-F Manifold is used for controlling water flow in underfloor heating systems. Each pipe in the floor heating system is connected to the manifold, thus making it possible to control water flow or heat supply to each room in the building individually.

The manifold comprises of a supply and return manifold. The supply manifold includes individual shut-off of each circuit as well as an individual flowmeter per circuit. The return manifold is equipped with integrated Danfoss pre-setting valves securing optimal hydraulic balance in the system.

The valves can be controlled electronically by thermal actuators or act as self-acting units by means of remote temperature adjusters.

The manifold is supplied in modules of up to 12 outlets. Ball valves are available as an option for positive shut-off between the manifold and the system.

The end pieces FHF-EM and FHF-EA are supplied with manual airvents or alternatively with automatic airvents.

### Additional Information:

Fittings options p. 19

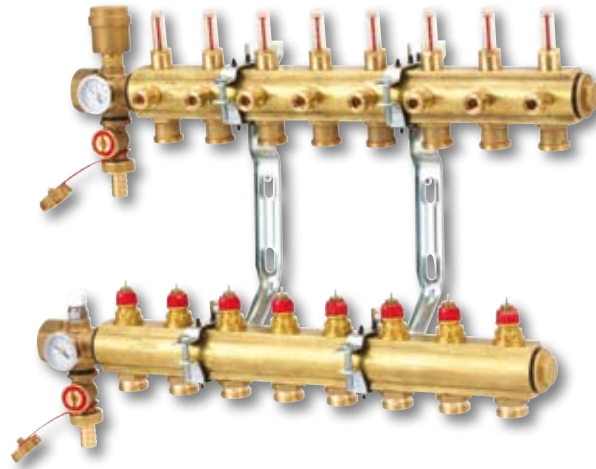

FHF-F

- **Easy mounting and installation**
- **Ultra compact size**
- **Energy saving**
- **Individual shut-off of each circuit**
- **Individual flowmeter per circuit**

Description	Type	Code No.
Manifold set 2+2, with flowmeter	FHF-2F	088U052200
Manifold set 3+3, with flowmeter	FHF-3F	088U052300
Manifold set 4+4, with flowmeter	FHF-4F	088U052400
Manifold set 5+5, with flowmeter	FHF-5F	088U052500
Manifold set 6+6, with flowmeter	FHF-6F	088U052600
Manifold set 7+7, with flowmeter	FHF-7F	088U052700
Manifold set 8+8, with flowmeter	FHF-8F	088U052800
Manifold set 9+9, with flowmeter	FHF-9F	088U052900
Manifold set 10+10, with flowmeter	FHF-10F	088U053000
Manifold set 11+11, with flowmeter	FHF-11F	088U053100
Manifold set 12+12, with flowmeter	FHF-12F	088U053200

Accessories	Type	Code No.
End section - automatic airvent and purge valve	FHF-EA	088U058000
End section - manual airvent and purge valve	FHF-EM	088U058100
End caps - set	FHF-E	088U058200
Connection pieces - set	FHF-C	088U058300
Reduction bushes/pieces - set - 1" - 3/4"	FHF-R	088U058400
Mounting brackets - set	FHF-MB	088U058500
2 x ball valve 1" with tail piece - for connection to manifold and for blocking of floor heating system	FHF-BV	058U058600
1 x thermometer 0-60°C Ø35mm - for flow/return temperature measurement	FHD-T	088U002900
Thermal actuator, 24V, NC, Danfoss RA connection to valve	TWA-A	088H311000
Thermal actuator, 230V, NC, Danfoss RA connection to valve	TWA-A	088H311200
Thermal actuator, 24V, NC, with end switch, Danfoss RA connection to valve	TWA-A	088H311400

See page 66 for the full range of TWA actuators.

# Underfloor Heating Valve FHV-R



Fittings



FHV-R

For small floor heating systems, which may include conservatories or bathrooms, Danfoss produce a range of self-acting controls, which are simple to install. The FHV-R comprises of a valve enclosure which is built into a wall or partition, a valve sensor and a fascia plate.

The FHV-R valve utilises a FJVR return temperature limiter sensor, which controls the temperature of the water leaving the floor heating circuit. As there is a good correlation between water and floor temperature, the FHV-R solution also ensures a warm floor is maintained.

The FHV-R is ideal for use in extensions to existing systems operating at normal flow and return temperatures (70 - 80°C) and provides the perfect solution for areas with high heat gains, such as conservatories. A mixing valve is not needed with this type of control.

Once installed, the user simply has to set the thermostat to the required floor temperature and leave it - the self-acting sensor will automatically limit the floor temperature to around 30°C. If the room is too cold or too hot the user can turn the sensor up or down until the required comfort setting is achieved.

### FHV-R Installation Rules

- Solid floor with minimum 75mm screed
- Pipe must be laid down in a snail pattern
- Maximum 15 square metre floor with 15mm pipe
- Maximum 300mm centre distance between pipes
- Maximum flow temperature 90°C

- **Easy to use**
- **No wiring**
- **Minimises running costs**
- **Good performance (self-acting proportional)**
- **Good value for money**

Feature	FHV-R
Code No. for valve and enclosure ( <b>does not include sensor</b> )	003L100000
FJVR sensor (temperature range 10-50°C). Order separately	003L104000
Installation position	Return
Connection sizes, see page 19 for pipe fittings options	G3/4", BSP, male
Integrated air-vent and air-vent key	-
Maximum operating pressure	6 bar
Maximum differential pressure	0.6 bar
Maximum flow temperature	90°C
<b>Compression Fittings</b> - order separately (see page19)	

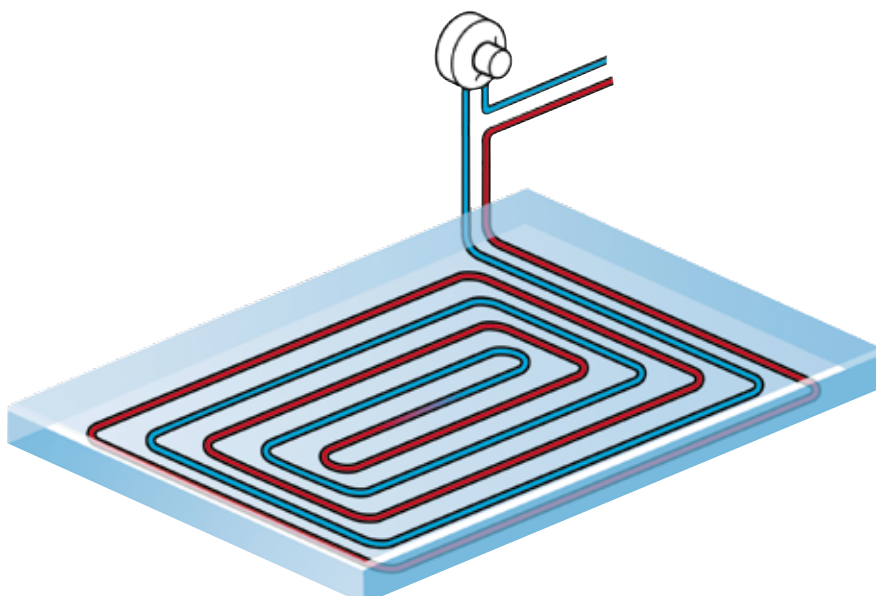

# Motorised Zone Valves and Other Controls Product Selector

<b>Control Packs</b>				
<b>Hard-Wired</b>		<b>Wireless</b>		<b>Page</b>
<i>2-Port</i>	<i>3-Port Mid Position</i>	<i>2-Port</i>	<i>3-Port Mid Position</i>	
Heatplan	Heatshare			<b>60</b>
		RF Packs	RF Packs	<b>61</b>

<b>Motorised Valves</b>						
<b>Paddle Type</b>			<b>Shoe Type</b>			<b>Page</b>
<i>2-Port</i>	<i>3-Port Mid Position</i>	<i>3-Port Diverter</i>	<i>2-Port</i>	<i>3-Port Mid Position</i>	<i>3-Port Diverter</i>	
HP B Series	HS3 B Series	HS3-DB Series				<b>62</b>
			HP Series	HS3 Series	HS3-D Series	<b>63</b>

<b>Pressure Controls</b>		
<i>Automatic Bypass Valves</i>	<i>Differential Pressure Valves</i>	<b>Page</b>
AVDO		<b>64</b>
ARV22		<b>64</b>
	AVPL	<b>68</b>

<b>Small Seated Valves</b>		
<i>2-Port</i>	<i>3-Port</i>	<b>Page</b>
RAV		<b>65</b>
VMT	VMV	<b>65</b>
	KOVM	<b>65</b>

<b>Miscellaneous Controls</b>		
<b>Self-Acting</b>	<b>Electric</b>	<b>Page</b>
<i>Hot Water Controller</i>	<i>Thermal Actuators</i>	
RAVI		<b>67</b>
	TWA	<b>66</b>



# Motorised Zone Valves and Other Controls For Optimum Control in Any Application

<i>Control Packs</i> ..... 60	<i>AVDO</i> ..... 64
Hard Wired Packs and Wiring Centres	Automatic Bypass Valve
<i>Control Packs</i> ..... 61	<i>RAV, VMT, KOVM and VMV</i> ..... 65
Wireless Packs	Small Seated Valves
<i>H-Series - Paddle Type</i> ..... 62	<i>TWA and ABV</i> ..... 66
Motorised Valves	Thermal Actuators
<i>H-Series - Shoe Type</i> ..... 63	<i>RAVI</i> ..... 67
Motorised Valves	Thermostatic Cylinder Controls
	<i>AVPL</i> ..... 68
	Differential Pressure Controls



# Control Packs

## Hard Wired Packs and Wiring Centres

**Competitively priced for the contracts market, Danfoss control packs offer the contractor integrated components for a trouble free installation.**

### Zone Valve Solution

#### Hard Wired Control Pack

All standard packs include a motorised valve(s), a room thermostat, a cylinder thermostat, a wiring centre and a programmer or timeswitch from the extensive Danfoss range.

Packs for Combi boiler systems and unvented hot water systems are also available please refer to our Sales Department for ordering details.

Ordering could not be simpler. Just quote the time control model followed by HSP for a Heatshare mid-position valve pack or HPP for a Heatplan 2-port pack with two 22mm zone valves.

For upgrading old systems, packs can be supplied without a time control, and/or without a wiring centre. Simply ask for an Untimed HSP or HPP or a pack without a wiring centre.

### Twin Pump Solutions

In addition to controls packs for zone valve-based solutions, Danfoss also supply packs specifically designed for Twin Pump Solutions as marketed by Grundfos. These packs contain a programmer (FP715 Si or SET3M), RET230P room thermostat and ATC cylinder thermostat.

### Additional Information:

Wiring information p. 71-76



**Hard Wired Control Pack**

- **Convenient, all-in-one solution**
- **Easy to buy and install**
- **Wide range of options available**
- **Cost effective solution**
- **Available in timed and untimed versions**
- **Service interval pack options available (FP715 Si and CP715 Si)**

Control Options <sup>(1) (2)</sup>					
Model	Time Control Type	Heatshare 3-Port Packs		Heatplan 2-Port Packs	
		Type	Code No	Type	Code No
	Untimed	Untimed HSP	087N652000	Untimed HPP	087N652040
SET2E	Mini-Programmer	SET2E HSP	087N651300	SET2E HPP	087N651340
SET3M	Programmer	SET3M HSP	087N650200	SET3M HPP	087N650240
SET3E	Programmer	SET3E HSP	087N651400	SET3E HPP	087N651440
CP715 Si	Programmer	CP715 Si HSP	087N650100	CP715 Si HPP	087N650140
FP715 Si	Full Programmer	FP715 Si HSP	087N850000	FP715 Si HPP	087N850040

Notes:  
 (1) All standard packs listed above contain 22mm valve (1 x 3-port valve or 2 x 2-port valves), RET230P room thermostat, ATC cylinder thermostats, plus WC4B wiring centre and relevant programmer.  
 (2) To order packs other than those listed above, please contact our Sales Department for ordering details

Unvented Control Pack Options <sup>(3)</sup>		
Model	Time Control Type	Code No
CP715 Si	Programmer	087N650152
FP715 Si	Full Programmer	087N650052
SET3M	Programmer	087N650252

Notes:  
 (3) Unvented control packs include programmer, 2 port 22mm valve, RET230P and WC4B wiring centre

Wiring Centres					
Model	Code No	Voltage Rating	Current Rating	Cable Clamps	Wiring Info
WC4B (20 way)	087N739900	230Vac ± 15%	10A res.	•	•

Please note: Additional control packs are available on request.

# Control Packs Wireless Packs



Wireless Control Pack

**A new concept in domestic heating controls aimed at 'speeding-up' the installation process in both new and existing domestic heating systems.**

Each Wireless Control Pack consists of a programmable room thermostat, programmable hot water thermostat and receiver. The thermostats use wireless communication to control the receiver.

Room temperature control is achieved by means of a TP7000-RF programmable thermostat which uses secure digital radio communication to control an RX receiver unit that can be mounted up to thirty metres from the thermostat.

A WP75-RF programmable hot water thermostat controls the temperature of the stored domestic hot water. The WP75-RF also utilises radio communication to control a second channel of the RX receiver. Wiring between thermostats and receiver is eliminated, significantly reducing installation time and removing the risk of damage to building fabric, decoration and furnishings.

In the standard pack the RX2-C receiver can be used to control conventional motorised zone valves on the heating and hot water circuits, or can be used to control the operation of heating and hot water pumps. The receiver incorporates an extra output to control the operation of the boiler and pump in zone valve based systems, doing away with the need to use auxiliary contacts within the zone valve. This significantly simplifies and reduces the risk of wiring errors. In pump based systems the extra output is used to control the boiler.

**Additional Information:**

Wiring information p. 71-76

- Suitable for motorised valve and multi-pump installations
- Wireless thermostats for ease of installation
- Provides programmed time and temperature control of heating and hot water

Wireless Control Packs - Fully RF		Pack Contents		
Description	Code No	Prog. Room Thermostat	Prog. Cylinder Thermostat	Motorised Valves
Pack for use with 2-port zone valves and 3-port mid-position valves	087N742100	TP7000-RF	WP75-RF	Not included
Pack for use with 3-port mid-position valves	087N742200	TP7000-RF	WP75-RF	1x22mm HS3
Pack for use with 2-port zone valves	087N742300	TP7000-RF	WP75-RF	2x22mm HP22
Pack for use with 3-port mid-position valves	087N742400	TP5000-RF	WP75-RF	1x22mm HS3
Pack for use with 2-port zone valves	087N742500	TP5000-RF	WP75-RF	2x22mm HP22
<i>Please note: All packs contain a WC4B wiring centre, 087N6500V5 includes RX1 receiver, all other packs include RX2C receivers.</i>				

Wireless Control Packs - Part Hard Wired		Pack Contents			
Description	Code No	Programmer	Room Thermostat	Cylinder Thermostat	Motorised Valves
Pack for use with 3-port mid-position valves	087N6500V3	FP715 Si	RET B-RF	CET B-RF	1x22mm HS3
Pack for use with 2-port zone valves	087N6500V4	FP715 Si	RET B-RF	CET B-RF	2x22mm HP22
Pack for use with unvented hot water systems	087N6500V5	FP715 Si	RET B-RF	By others	1x22mm HP22
<i>Please note: All packs contain a WC4B wiring centre, 087N6500V5 includes RX1 receiver, all other packs include RX2C receivers.</i>					

# Motorised Valves H-Series - Paddle Type

For central heating and hot water circulation in wet domestic central heating systems.

H-series 'paddle' valves are available in 2-port and 3-port versions in a wide range of sizes for both copper and iron pipework. All valves offer 100% tight shut-off. Actuators for mid-position, diverter and 2-port on/off applications complete the range.

Valve bodies and actuators may be purchased separately or in convenient sets. For ease of installation and serviceability, assembly of the actuator to the valve body is made on site, using the screws provided.

The spring return actuators have auxiliary switches and one metre of cable with Industry Standard wire colours. A lever enables the valves to be opened manually, useful when filling the system.

Danfoss valve actuators are designed for direct in-service replacement of actuators on other makes of motorised valves (see compatibility chart opposite).

**Additional Information:**  
Wiring information p. 75



2-Port Paddle Valve



3-Port Paddle Valve

- Available in 2-port, 3-port diverter and 3-port mid-position versions
- Wide range of valve body sizes
- Interchangeable actuators

3-Port Paddle Valves (Spring Return to Heating Closed) <sup>(4)</sup>						
Valve Size & Connection Details	Complete Valve Body & Actuator				Valve Body Only	
	Mid Position <sup>(1)</sup>		Diverter <sup>(2)</sup>		Type	Code No
	Type	Code No	Type	Code No		
22mm (ext. compression)	HS3B	087N664600	HS3DB22	087N665300	HSV3B22	087N662500
28mm (ext. compression)	HS3B28	087N665100	HS3DB28	087N666000	HSV3B28	087N663000
15mm/1/2" BSP (int. comp.)	HS3B15	087N665000	HS3DB15	087N665900	HSV3B15	087N662900
3/4" BSP (female)	HS3B0.75	087N664800	HS3DB0.75	087N665400	HSV3B0.75	087N662600
1" BSP (female)	HS3B1.0	087N664900	HS3DB1.0	087N665800	HSV3B1.0	087N662800

Notes:  
(1) Includes HSA3 Actuator  
(2) Includes HSA3D Actuator

2-Port Paddle Valves (Spring Return to Closed) <sup>(4)</sup>						
Valve Size & Connection Details	Complete Valve Body & Actuator		Actuator Only		Valve Body Only	
	Type	Code No	Type	Code No	Type	Code No
22mm (ext. compression)	HP22B	087N664200	HPA2	087N657900	HPV22B	087N662200
28mm (ext. compression)	HP28B	087N664400	HPA2	087N657900	HPV28B	087N662400
28mm (ext. compression)	HP28BC <sup>(3)</sup>	087N664500	HPA2C	087N658000	HPV28B	087N662400
15mm/1/2" BSP (int. comp.)	HP15B	087N664000	HPA2	087N657900	HPV15B	087N662100
3/4" BSP (female)	HP0.75B	087N663400	HPA2	087N657900	HPV0.75B	087N661800
1" BSP (female)	HP1.0B	087N663700	HPA2	087N657900	HPV1.0B	087N662000

Notes:  
(3) For Gravity Hot Water Systems  
(4) Max flow temperature 95°C, max working pressure 10 bar, max differential pressure 15mm, 22mm, 1/2" & 3/4" = 1.0 bar; 28mm & 1" = 0.7bar

Motorised Valve Actuators				
Description	Code No	Type	Voltage	Aux. Switch Detail
3-Port Mid-Position Valve Actuator	087N658700	HSA3	230Vac ±15%	SPST <sup>(5)</sup>
3-Port Diverter Valve Actuator	087N658900	HSA3D	230Vac ±15%	SPST Aux. Sw.
2-Port Valve Actuator (normally closed)	087N657900	HPA2	230Vac ±15%	SPST (volt free)
2-Port Valve Actuator (normally closed)	087N658000	HPA2C	230Vac ±15%	SPDT Aux. Sw.

Notes: (5) Linked Internally

# Motorised Valves H-Series - Shoe Type



2-Port Shoe Valve



3-Port Shoe Valve

- Available in 2-port, 3-port diverter and 3-port mid-position versions
- Wide range of valve body sizes
- Interchangeable actuators

For central heating and hot water circulation in wet domestic central heating systems.

H-series 'shoe' valves are available in 2-port and 3-port versions in a wide range of sizes for both copper and iron pipework. Actuators for mid-position, diverter and 2-port on/off applications complete the range.

Valve bodies and actuators may be purchased separately or in convenient sets. For ease of installation and serviceability, assembly of the actuator to the valve body is made on site, using the screws provided.

The high capacity bodies incorporate two self-cleaning positive shut-off shoes. Flow through the 2-port valves can be in either direction.

The spring return actuators have auxiliary switches and one metre of cable with Industry Standard wire colours. A lever enables the valves to be opened manually, useful when filling the system.

Danfoss valve actuators are designed for direct in-service replacement of actuators on other makes of motorised valves (see compatibility chart below).

**Additional Information:**  
Wiring information p. 75

3-Port Shoe Valves (Spring Return to Heating Closed) <sup>(4)</sup>						
Valve Size & Connection Details	Complete Valve Body & Actuator				Valve Body Only	
	Mid Position <sup>(1)</sup>		Diverter <sup>(2)</sup>		Type	Code No
	Type	Code No	Type	Code No		
22mm (ext. compression)	HS3	087N661300	HS3D	087N661400	HSV3	087N659900

Notes: (1) Includes HSA3 Actuator  
(2) Includes HSA3D Actuator

2-Port Shoe Valves (Spring Return to Closed) <sup>(5)</sup>						
Valve Size & Connection Details	Complete Valve Body & Actuator		Actuator Only		Valve Body Only	
	Type	Code No	Type	Code No	Type	Code No
22mm (ext. compression)	HP22	087N660900	HPA2	087N657900	HPV22	087N659700
28mm (ext. compression)	HP28	087N661100	HPA2	087N657900	HPV28	087N659800
28mm (ext. compression)	HP28C <sup>(3)</sup>	087N661200	HPA2C	087N658000	HPV28	087N659800
15mm (int. compression)	HP15	087N660800	HPA2	087N657900	HPV15	087N659600
3/4" BSP (female)	HP0.75	087N660200	HPA2	087N657900	HPV0.75	087N659400
1" BSP (female)	HP1.0	087N660400	HPA2	087N657900	HPV1.0	087N659500

notes: (3) For Gravity Hot Water Systems

Motorised Valve Actuators				
Description	Code No	Type	Voltage	Aux. Switch Detail
3-Port Mid-Position Valve Actuator	087N658700	HSA3	230Vac ±15%	SPST <sup>(4)</sup>
3-Port Diverter Valve Actuator	087N658900	HSA3D	230Vac ±15%	SPST Aux. Sw.
2-Port Valve Actuator (normally closed)	087N657900	HPA2	230Vac ±15%	SPST (volt free)
2-Port Valve Actuator (normally closed)	087N658000	HPA2C	230Vac ±15%	SPDT Aux. Sw.

Notes:

(4) Linked Internally

(5) Max flow temp 95°C, max working pressure 10 bar, max differential pressure 15mm, 22mm, 1/2" & 3/4" = 1.0 bar; 28mm & 1" = 0.7bar

Compatibility Chart Danfoss Actuators & Valve Bodies are interchangeable with other makes				
Danfoss Randall Code	Landis & Gyr (ext.)	Landis & Gyr (int.)	Pegler Sunvic	Potterton
HSA3 Actuator	SK3	SK3	SD1701/2701	PMV3
HSV3 Valve - 22mm	LT8322	LT2701 <sup>(6)</sup>	EDT1702	PMV3
HPA2 Actuator	SK2	SK2	SZ1301/2301	PMV2
HPV22 - 22mm	LL8222	LL4453 <sup>(6)</sup>	EML3454	PMV2
HPV28 - 28mm	-	33 4501	EML3503	-

Notes: (6) These references are for older types of L&G valve bodies, having internal compression fittings - some pipework change will be required.



# Automatic Bypass Valves

## AVDO

Many boiler manufacturers are insisting that a bypass be fitted in all installations in order to ensure that the volume of water circulating through the boiler does not fall to below a predefined minimum, regardless of the load on the system.

Recognising the energy efficiency advantage of such controls the Building Regulations now require that in both new-build and boiler replacement contexts, where a bypass is specified by the boiler manufacturer, that an automatic bypass is fitted.

Automatic bypass valves improve system efficiency by opening only when there is a need to bypass water, this usually occurs at times of part load when radiator thermostats in the system are partly closed and water flow around the boiler is restricted.

In addition to ensuring adequate flow around the boiler, automatic bypass valves also prevent pump pressure from climbing significantly above design levels, thus significantly reducing the risk of noise in the system.

### AVDO Range

These straight pattern valves are available in 15, 22 and 28mm sizes. The carrying capacity of this range of valves is very high with large but linear changes in water throughput for relatively small increases in differential pressure. This allows a 15mm valve to be used in situations where 22mm valves are normally required.

### ARV22

This valve is a compact angled pattern design available only in 22mm. The ARV22 is a well engineered solution, competitively priced and provides a sufficient bypass for most small to medium sized domestic heating systems.



AVDO

ARV22

- Easy to set, self acting solution
- Reduces risk of noise in systems fitted with radiator thermostats
- Improves system efficiency
- Maintains minimum flow rates through boiler and pump
- Essential in low water content boiler systems

AVDO Automatic Bypass Valves			
Model	Code No	Straight Pattern Valves - Connections	
		Inlet	Outlet
AVDO 15	003L611500	15mm	15mm
AVDO 20	003L612200	22mm	22mm
AVDO 25	003L612800	28mm	28mm
AVDO 15	003L601800	1/2" BSP (Female)	1/2" BSP (Male)
AVDO 20	003L602300	3/4" BSP (Female)	3/4" BSP (Male)
AVDO 25	003L602800	1" BSP (Female)	1" BSP (Male)
AVDO Automatic Bypass Valve Spares			
Code No		Description	
013U013000		Spare 15mm Compression Fitting	
013U135500		Spare 22mm Compression Fitting	
013U014000		Spare 28mm Compression Fitting	

Specification	AVDO	ARV22
Setting Range	0.05 - 0.5 Bar	0.05 - 0.5 Bar
Maximum Working Pressure	10 Bar	4 Bar
Maximum Temperature	100°C	100°C

Please Note: AVDO may be operated at 120°C for short periods

ARV22 Automatic Bypass Valve			
Model	Code No	Angled pattern valve, Connections	
		Inlet	Outlet
ARV22	099-106300	22mm	22mm

# Small Seated Valves RAV, VMT, KOVM and VMV

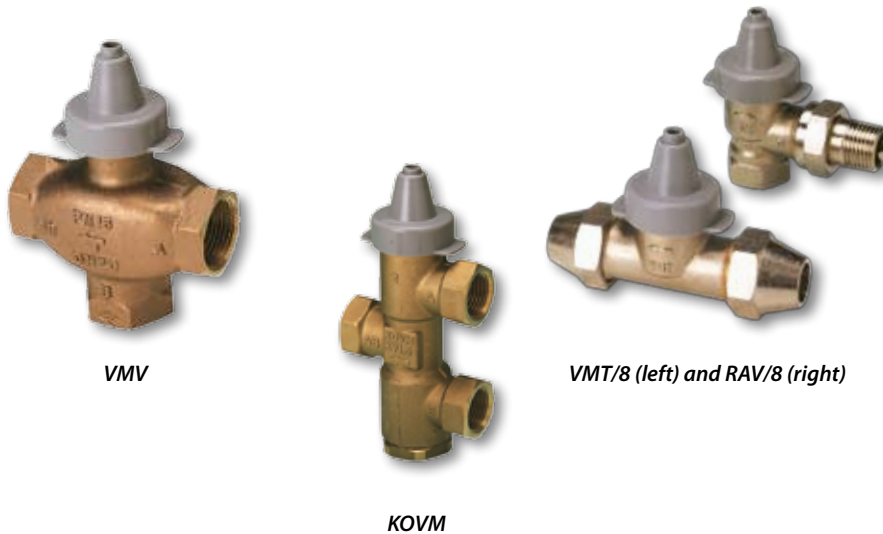

Small seated valves are used with a wide range of self-acting temperature controls and electric actuator applications.

Available in two or three port versions, small-seated valves can be used with a wide range of self-acting temperature controls and electric actuators.

Applications include control of Hot Water Systems, Blending Circuits for Underfloor Heating, Heating Zones and Fan Coil & Induction Units.

### RAV/VMT 2 Port Seated Valves

The RAV and VMT 2-port, high capacity seated valves can be used with a wide range of self-acting temperature controls and electric actuators.

Applications include injection mixing circuits for floor heating applications.

### VMV/KOVM 3 Port Seated Valves

VMV and KOVM 3-port high capacity mixing valves can be used with a wide range of self-acting temperature controls and electric actuators.

Typical applications include mixing circuits for floor heating and diverting applications, or any zone control application where circulating water volumes in the system must remain constant.

- Wide range of sizes and capacities
- Available in 2-port and 3-port versions
- Suitable for use with self-acting and electric actuators
- High operating temperature and pressure limits

2-Port Seated Valves						
Pattern	Type	Code No	Connections		Kvs (m <sup>3</sup> /h)	Max. Diff Press (Bar)
			Inlet	Outlet		
Angled	RAV 10/8	013U001100	3/8"BSP (F)	3/8"BSP(M)	1.2	0.8
	RAV 15/8	013U001600	1/2"BSP(F)	1/2"BSP(M)	1.5	0.8
	RAV 20/8	013U002100	3/4"BSP(F)	3/4"BSP(M)	2.3	0.8
	RAV 25/8	013U002600	1"BSP(F)	1"BSP(M)	3.1	0.8
Straight	RAV 10/8	013U001200	3/8"BSP (F)	3/8"BSP(M)	1.2	0.8
	RAV 15/8	013U001700	1/2"BSP(F)	1/2"BSP(M)	1.5	0.8
	RAV 20/8	013U002200	3/4"BSP(F)	3/4"BSP(M)	2.3	0.8
	RAV 25/8	013U002700	1"BSP(F)	1"BSP(M)	3.1	0.8
	VMT 15/8	065F011501	15mm	15mm	1.5	0.8
	VMT 20/8	065F012001	22mm	22mm	2.3	0.8
	VMT 25/8	065F012501	28mm	28mm	3.1	0.8
	VMT 15/2	065F011401	15mm	15mm	2.8	0.2
	VMT 20/2	065F011901	22mm	22mm	5.0	0.2
	VMT 25/2	065F012401	28mm	28mm	8.0	0.2

Maximum working temperature 120°C. Maximum operating pressure 10 Bar.

Compression Fittings - VMT supplied c/w fittings for copper pipe see p. 19 for plastic pipe options. Not available for RAV.

3-Port Seated Valves (Mixing)						
3-Port Mixing Valves	KOVM	013U301500	1/2"BSP(F)	1/2"BSP(F)	1.5	0.8
	KOVM	013U302000	1/2"BSP(F)	1/2"BSP(F)	2.0	0.8
	VMV 15	065F001500	1/2"BSP(F)	1/2"BSP(F)	2.5	0.6
	VMV 20	065F002000	3/4"BSP(F)	3/4"BSP(F)	4.0	0.5
	VMV 25	065F002500	1"BSP(F)	1"BSP(F)	6.3	0.3
	VMV 32	065F003200	1 1/4"BSP(F)	1 1/4"BSP(F)	10.0	0.2
	VMV 40	065F004000	1 1/2"BSP(F)	1 1/2"BSP(F)	14.0	0.2

Maximum working temperature RAV, VMT & VMV 120°C, KOVM 90°C. Maximum operating pressure 10 Bar.

Compression Fittings - refer to p. 19 for fittings available for KOVM. Not available for VMV.

Valve/Actuator Compatibility Chart								
Valve	Sensor/Actuator Type							
	RA/V	RA 5060	TWA-V(NO)	TWA-V(NC)	ABV(NO)	ABV(NC)	RAVI	RAVK
RAV/8	•	•	•	•	•	•	•	•
VMT/8	•	•	•	•	•	•	•	•
VMT/2	•	•			•	•	•	•
VMV 15-20			•	•	•	•	•	•
VMV 25-40					•			
KOVM			•	•	•	•	•	•

# Thermal Actuators

## TWA and ABV

**Electrical control of radiators, heating zones and hot water service control, where other control devices provide simple on/off regulation.**

### TWA Series Thermal Actuators

These low-cost wax filled thermal actuators are suitable for many zoning applications, including floor heating. They are available in either normally open (N.O.) or normally closed (N.C.) models, in both 230 Volt and 24 Volt versions. All models have a very low power consumption of just 2 Watts.

TWA-A models are equipped with the standard Danfoss RA2000 connection, allowing them to be used on any of the Danfoss valve range having a 17mm RA2000 neck - this includes RA-FS, RA-FN, RA-N and RA-G radiator thermostat valve bodies, and high capacity RA-C 2-port valves. Used together with electric room thermostats, the combination of TWA-A and any of the aforementioned valve bodies can provide cost effective electric control for individual radiators, or small groups of radiators, for example in hotel rooms. TWA-A can also be used together with floor heating manifolds, type FHF-F, and electric room thermostats to provide zone control of floor heating circuits.

TWA-V models are equipped with the Danfoss RAV connection, allowing them to be used on all Danfoss valves having a 34mm neck connection. This includes RAV, VMT and KOVM 3-port valves. Applications include on/off control of small heating zones and fan coil units, including cooling coils, where on/off control is specified.

### ABV Series Actuators

These models offer greater power than the TWA series and will fit all Danfoss valves with a 34mm neck connection - these include RAV, VMT, KOVM and VMV 3-port valves. Some restrictions do apply - please refer to the table opposite for compatibility. Applications include on/off control of heating or zones and fan coil units, including cooling coils, where on/off control is specified.



TWA-A



ABV

- Simple two wire operation
- Available in 230V and 24V versions
- Can be used with a wide variety of small seated valves
- Suitable for use on AC and DC circuits
- Available in Normally Open and Normally Closed configurations
- Position indicator on TWA models

Thermal Actuator Valve Compatibility Table											
Type Code	Code No	Compatible Valve Bodies <sup>(1)</sup>							Volt.	Power Cons (mean)	
		RA-FN	RA-N	RAV-/8	VMT-/8	VMT-/2	VMV 15-20	VMV 25-40			KOVM
TWA-A (NC)	088H311200	•	•							230V	2W
TWA-A (NO)	088H311300	•	•							230V	2W
TWA-A (NC)	088H311000	•	•							24V	2W
TWA-A (NO)	088H311100	•	•							24V	2W
TWA-A (NC) AUX	088H311400	•	•							24V	2W
TWA-V (NO)	088H312300			•	•				•	230V	2W
TWA-V (NC)	088H312200			•	•				•	230V	2W
TWA-V (NO)	088H312100			•	•				•	24V	2W
TWA-V (NC)	088H312000			•	•				•	24V	2W
ABV (NO)	082F000100			•	•	•	•	•	•	230V	9W
ABV (NC)	082F005100			•	•	•	•	•	•	230V	9W
ABV (NO)	082F000200			•	•	•	•	•	•	24V	9W
ABV (NC)	082F005200			•	•	•	•	•	•	24V	9W

Note (1)  
 When mounted on a 2-port valve, Normally Open (NO) versions are closed when power is applied.  
 When mounted on a 2-port valve, Normally Closed (NC) versions are open when power is applied.

# Thermostatic Cylinder Controls RAVI and RAVK



RAVI-VMT 20/2



RAVK



RAVI-KOVM

*Ideal for system upgrade situations where consumers want the benefits of temperature controlled hot water, without the inconvenience of lifting floor boards.*

The RAVI offers a simple non-electric alternative to the more traditional motorised valve and electric cylinder thermostat, and is available in 2-port versions for pumped and gravity systems, and in a 3-port version for pumped systems.

To ease installation, the sensor is designed for “clamp-on” mounting, using a strap and adhesive pad provided. For situations that demand immersion sensing, an immersion pocket or capillary gland seal is also available.

The low temperature version, type RAVK is particularly suited to under floor heating applications - please refer to ‘small-seated valves’ section for suitable valve bodies.

- Self acting control, requires no wiring
- Versions available for pumped and gravity systems
- 2-port pumped versions in 15mm and 22mm sizes
- 2-port gravity versions in 22mm and 28mm sizes
- 3-port pumped versions in 15mm or 1/2" BSP sizes

RAVI Thermostatic Cylinder Controls			
Model	Code No	Description	Kv Xp = 6K
<b>Complete 2-port Valve &amp; Thermostat Assemblies</b>			
RAVI - VMT 15/8	013U808100	15mm for pumped primaries	1.3
RAVI - VMT 20/8	013U808200	22mm for pumped primaries	2.4
RAVI - VMT 20/2	013U808500	22mm for gravity primaries	4.1
RAVI - VMT 25/2	013U808600	28mm for gravity primaries	5.6
<b>Complete 3-port Valve &amp; Thermostat Assembly</b>			
RAVI - KOVM	013U808700	15mm or 1/2" BSP for pumped primaries	2.0
<b>Accessories, Spares &amp; Alternative Sensors</b>			
Model	Code No	Description	
RAVI	013U801300	Thermostatic element and sensor with 1.5m capillary tube. Setting range 43°C - 65°C <sup>(1)</sup>	
RAVK	013U806300	Thermostatic element and sensor with 2m capillary tube. Setting range 25°C - 65°C <sup>(1)</sup>	
	013U013000	Spare 15mm compression fitting for VMT 15/8 valves.	
	013U013500	Spare 22mm compression fitting for VMT 20/8 & VMT 20/2 valves.	
	013U014000	Spare 28mm compression fitting for VMT 25/2 valves.	
	013U411500	Spare 15mm compression fitting for KOVM valves.	
	013U007000	Spare Gland Seal for 2-port & 3-port valves.	
	017-436766	1/2" BSP sensor pocket.	
Note: (1) RAVI and RAVK elements can be used with other valve bodies - see page 63.			

# Differential Pressure Controls AVPL - For District Heating Consumer Units

**AVPL differential pressure controls are used in group and district heating systems to control differential pressure within a dwelling.**

This type of control is essential in such systems where high pump pressures are the norm. These valves perform the function of reducing the pump pressure present within the dwelling from the relatively high level normally present in district heating systems to the substantially lower level required within the dwelling.

Unlike conventional static pressure balancing valves, differential pressure controllers are able to maintain the differential pressure within the dwelling at a constant figure, regardless of the flow rate within the dwelling which is constantly changing as radiator thermostats and other control valves vary the water flow dependent upon load.

AVPL valves are mounted in the return pipework from the dwelling, immediately prior to the connection to the district heating return.

Danfoss produce a wide range of automatic bypass valves, differential pressure controllers and flow regulators for use on medium to large systems. The range includes valve sizes up to 250mm for use on systems operating up to 40 bar working pressure and 150°C.

For full details visit [www.heating.danfoss.com](http://www.heating.danfoss.com)

**Please note:**

AVPL differential pressure regulators supersede earlier AVDL models. Functionality is more or less the same, although it is important to note that AVPL models can only be mounted in the system return. Please refer to the cross reference table to select a replacement product.



AVPL

- **Maintains constant differential pressure, regardless of flow rates**
- **Establishes and maintains system balance**
- **Compact design, ideal for consumer units**
- **Self-acting controls, no external power required**

Differential Pressure Control Valve					
Type	Code No	Size	Set Range (Bar)	Kv (m3/h)	Comments
AVPL 1.0 <sup>(1)</sup>	003L503001	½" <sup>(2)</sup>	0.05 - 0.25	1.0	Supplied complete with impulse tube and nipple
AVPL 1.6 <sup>(1)</sup>	003L503101	½" <sup>(2)</sup>	0.05 - 0.25	1.6	

Notes:  
 (1) Valve must be mounted in return, observing flow direction arrow  
 (2) Supplied complete with 2 x ½" BSP male connections  
 Max. working pressure: 10 Bar, Max. operating temperature: 110°C, Max. differential pressure: 4.5Bar.

Example of AVPL Installation

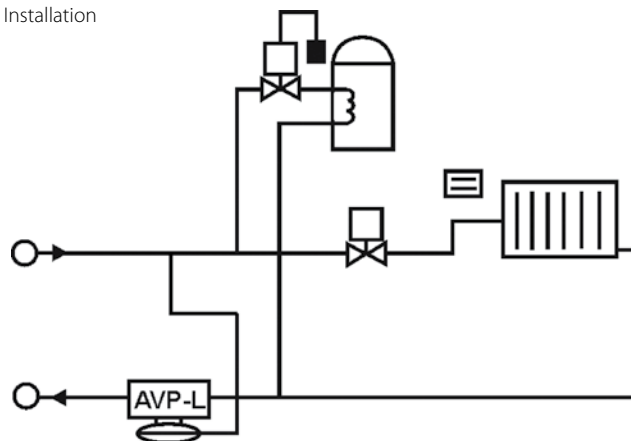



# Additional Information

## Wallplates, Wiring, Schematics and Regulations

<i>Wallplate Identification and Compatibility</i> .....	70	<i>Hard Wired Underfloor Heating System</i> .....	82
<i>Wiring Diagrams</i> .....	71-76	Schematic Diagram	
<i>Combi Boiler System</i> .....	77	<i>Wireless Underfloor Heating System</i> .....	83
Schematic Diagram		Schematic Diagram	
<i>Mid-Position Valve System</i> .....	78	<i>Radiator Thermostat Selection</i> .....	84
Schematic Diagram		<i>Commercial TRV Selection</i> .....	85
<i>Two Port Zone Valve System</i> .....	79	<i>Literature Service</i> .....	86
Schematic Diagram		<i>Warranty and Returns Policy</i> .....	87
<i>Two Port Zone Valve System With Additional Heating</i> .....	80		
Schematic Diagram			
<i>Radio Frequency</i> .....	81		
Control Packs and Wiring			



# Additional Information

## Wallplate Identification and Compatibility

### GP Wallplate

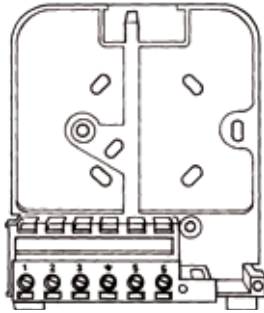

#### Timeswitches

103  
103E7

1	2	3	⊥	5	6
ON	SPARE	COM	E	N	L
Mains supply (via 3 amp fuse)					

#### Mini-Programmers

102  
102E7

1	2	3	⊥	5	6
DHW	HTG	COM	E	N	L
Mains supply (via 3 amp fuse)					

### MK18 Wallplate

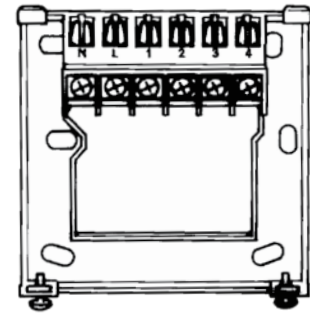

#### Timeswitch

TS715 Si

N	L	1	2	3	4
Mains (via 3 amp fuse)		COM	OFF	SPARE	ON

(supersedes TS15 and TS75)

#### Programmers

CP715 Si  
FP715 Si

N	L	1	2	3	4
Mains (via 3 amp fuse)		OFF	OFF	ON	ON
		DHW	HTG	DHW	HTG

(supersedes MP15, MP75, CP15, CP75, FP15, FP75, FP715 and CP715)

### SET Wallplate

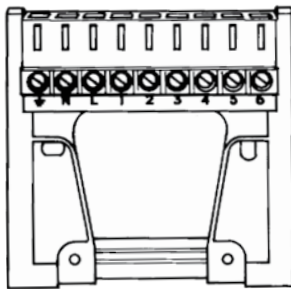

#### Timeswitches

SET1E

⊥	N	L	1	2	3	4	5	6
Mains Supply (via 3 amp fuse)			Spares			Load		
						ON	COM	OFF

Link 1-5 at time of installation

#### Mini-Programmer

SET2E

⊥	N	L	1	2	3	4	5	6
Mains Supply (via 3 amp fuse)			Water			Heating		
			ON	COM	OFF	ON	COM	OFF

#### Programmers

SET3E  
SET3M  
FP975\*

⊥	N	L	1	2	3	4	5	6
Mains Supply (via 3 amp fuse)			Water			Heating		
			ON	COM	OFF	ON	COM	OFF

### MK3 Wallplate



#### Programmer

4033

1	2	3	4	5	6	7	⊥
Water	Heating		Water		L	N	E
COM	ON	OFF	ON	OFF	Mains supply (via 3 amp fuse)		

#### Mini-Programmers

3020P  
3060

1	2	3	4	5	6	7	⊥
Neutral	Heating		Water		L	N	E
ON	Spare	ON	Spare	Mains supply (via 3 amp fuse)			

### MK9\* Wallplate (discontinued)

FP975 is a plug-in replacement to MK9, but must be set in MK9 mode using the switch on the rear of the unit.

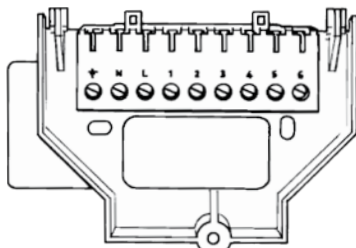

#### Programmers

FP975  
replaces  
922 and 972

⊥	N	L	1	2	3	4	5	6
Mains Supply (via 3 amp fuse)			Water			Heating		
			OFF	COM	ON	OFF	COM	ON

# Additional Information Wiring Diagrams

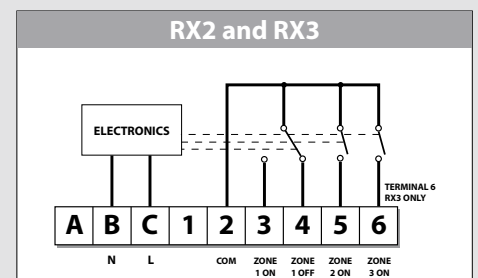
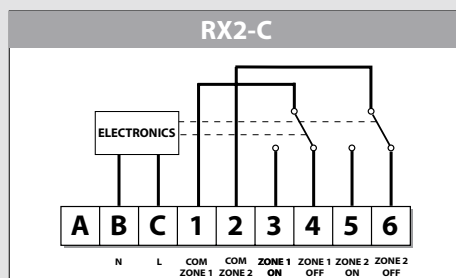
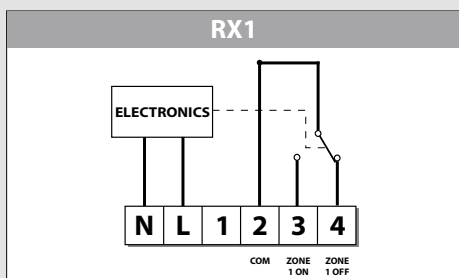
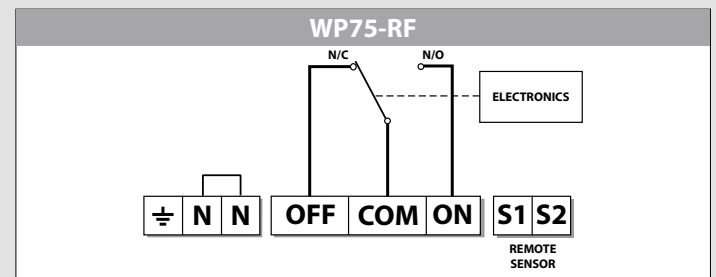
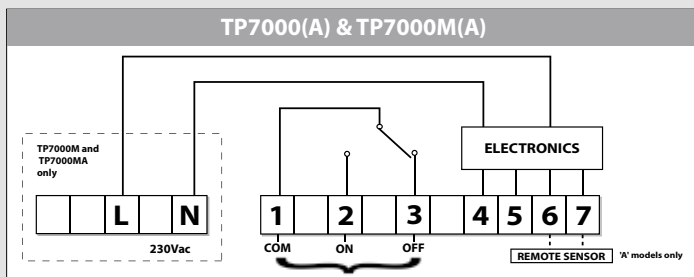
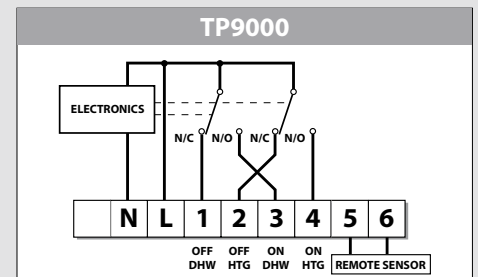
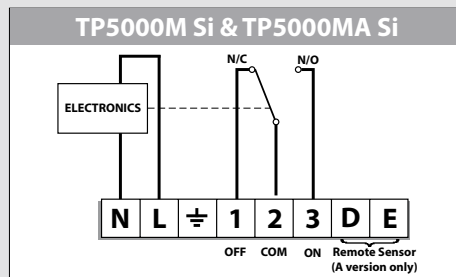
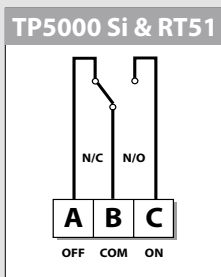
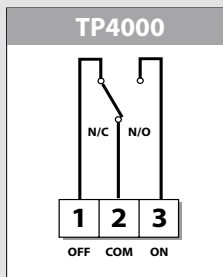
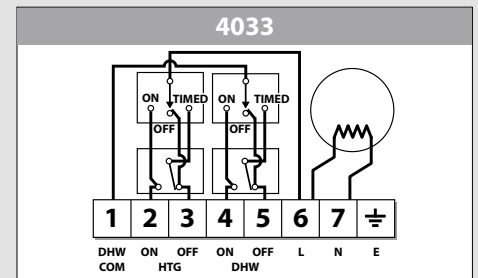
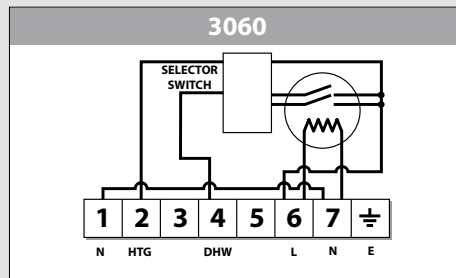
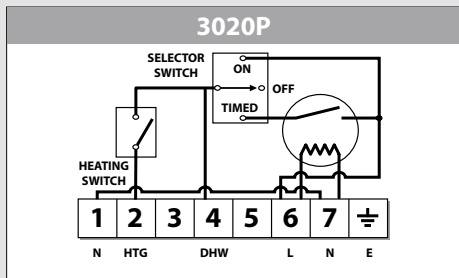
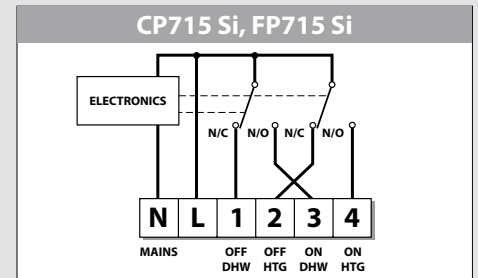
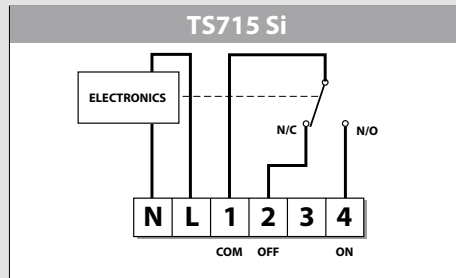
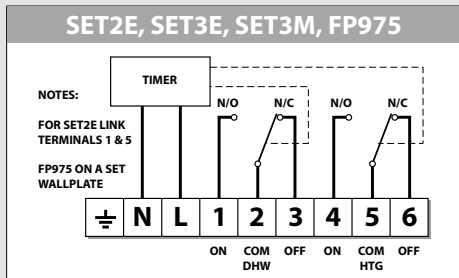
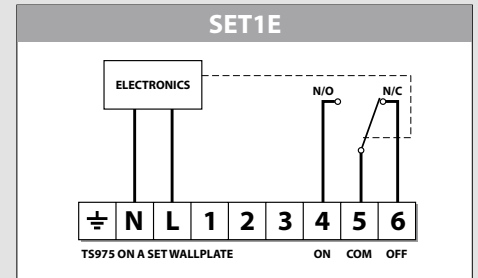
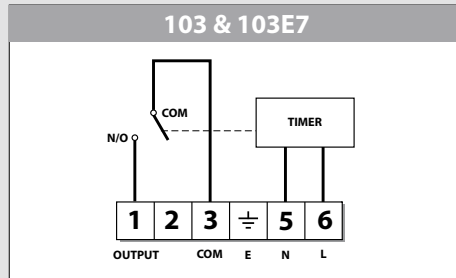
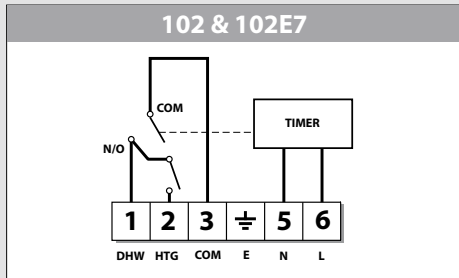

# Additional Information Wiring Diagrams

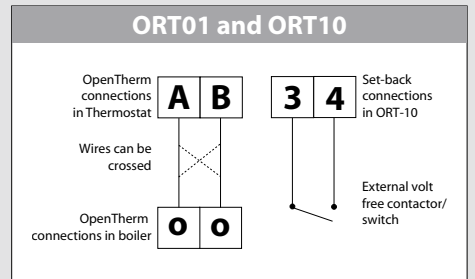
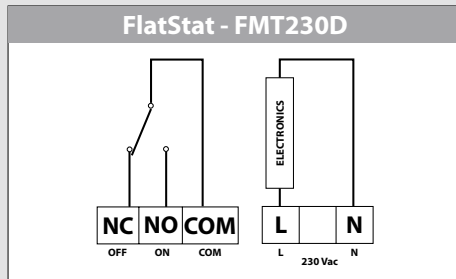
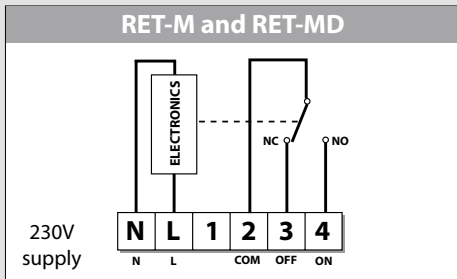
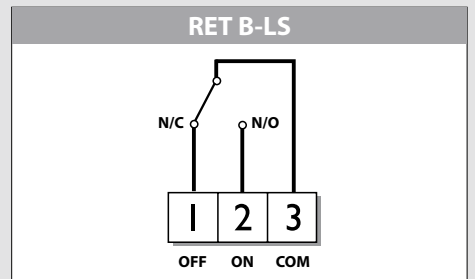
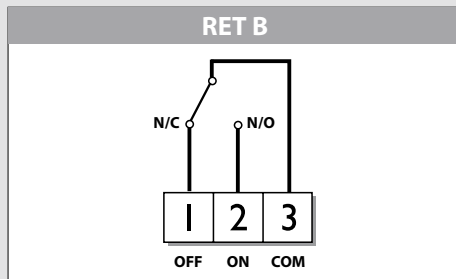
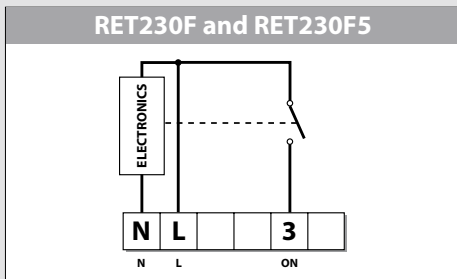
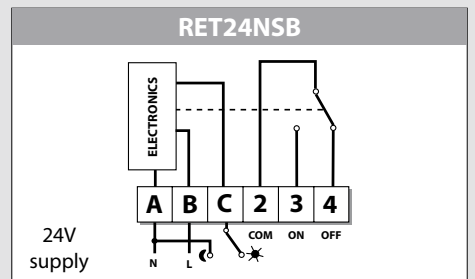
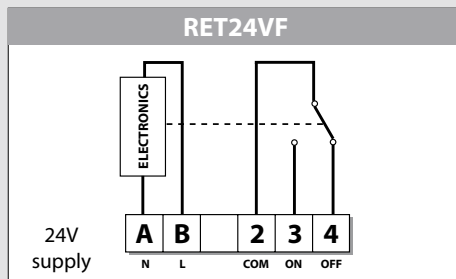
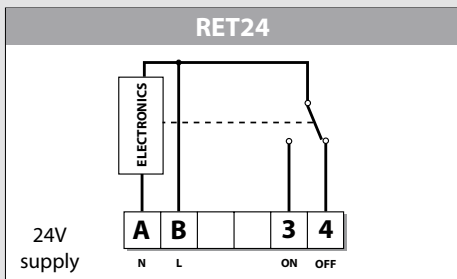
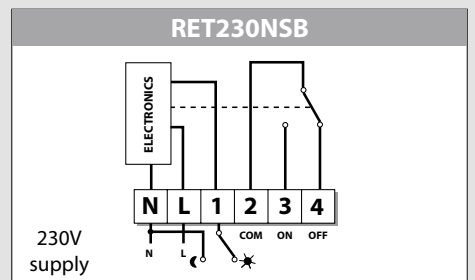
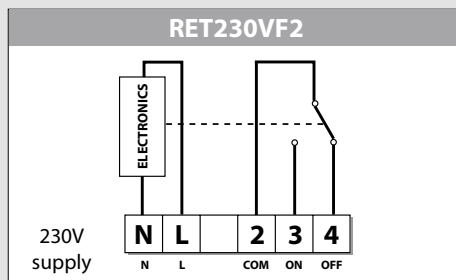
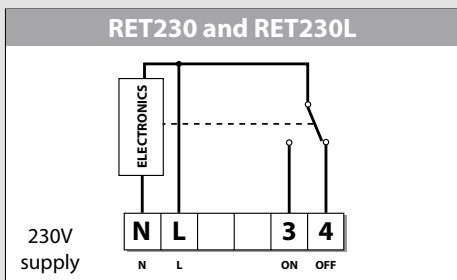
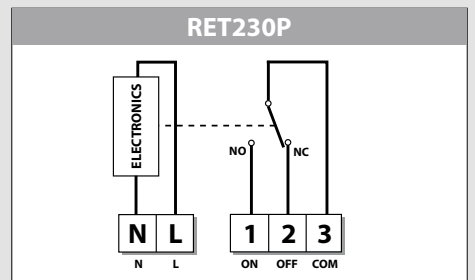
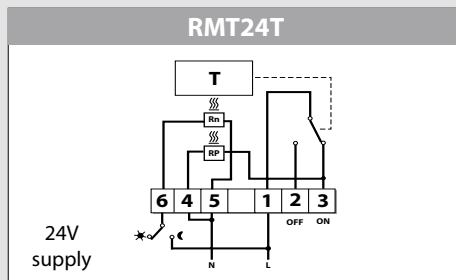
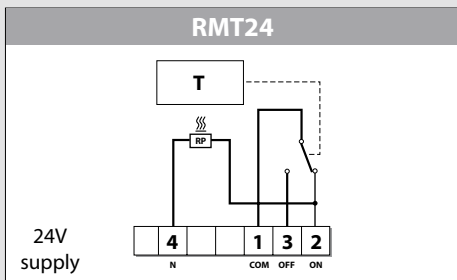
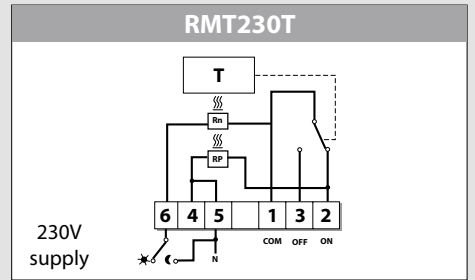
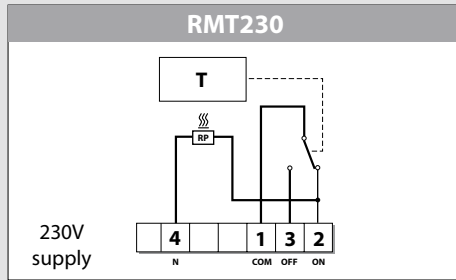
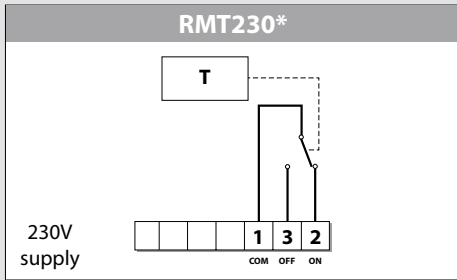

# Additional Information Wiring Diagrams

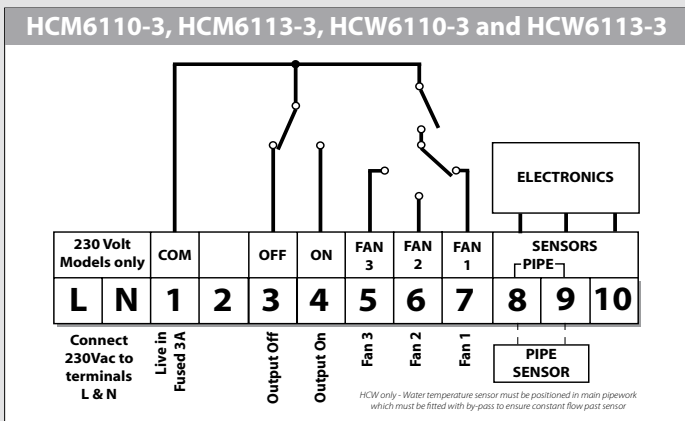
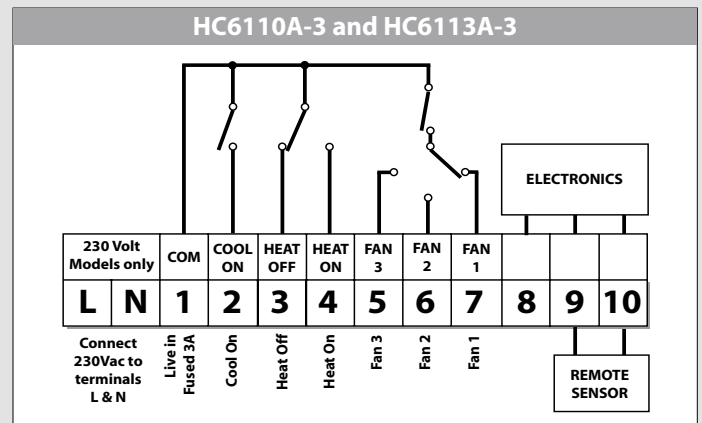
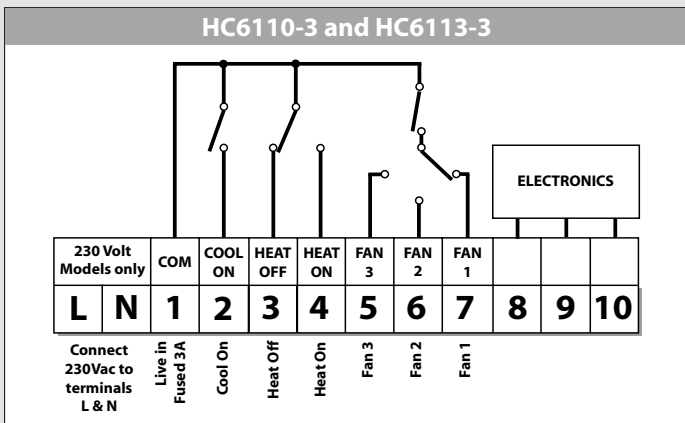
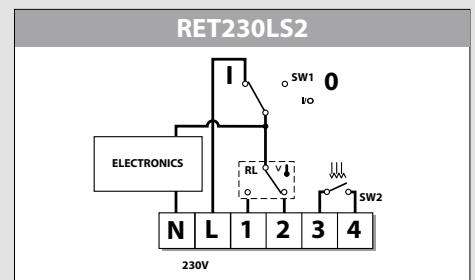
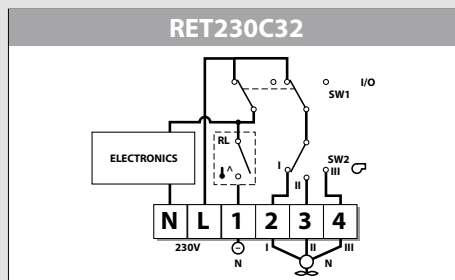
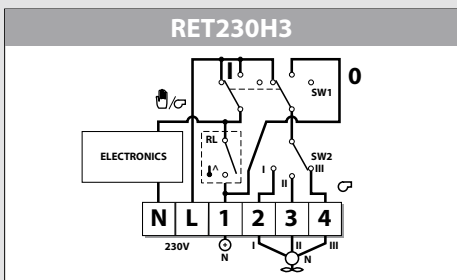
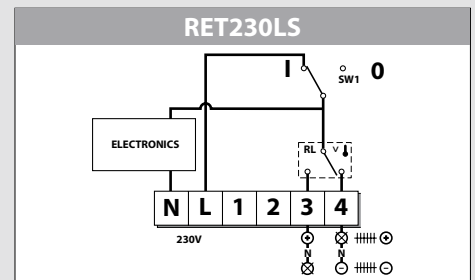
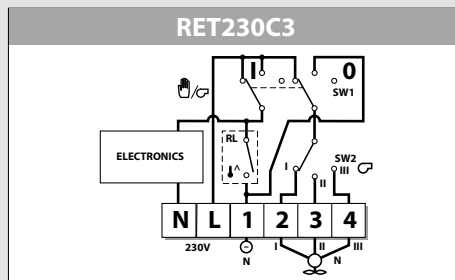
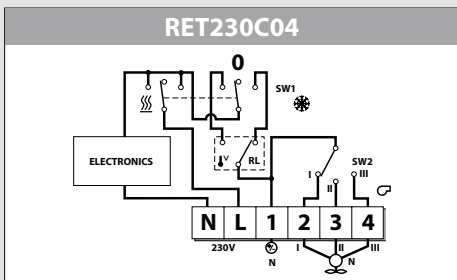
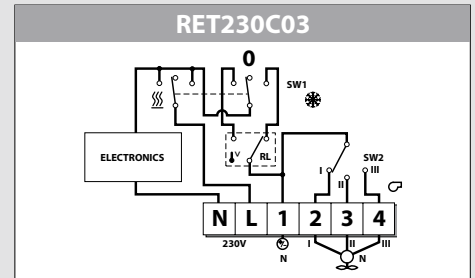
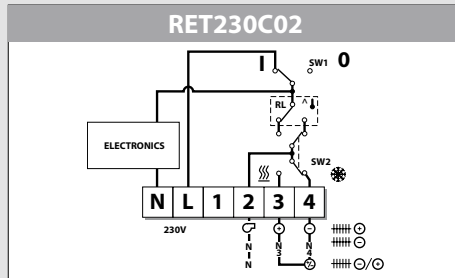
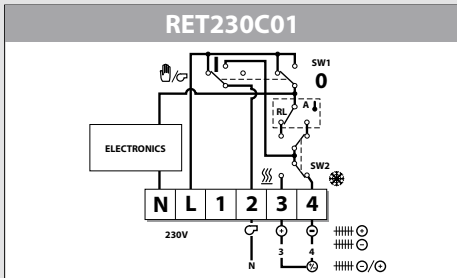



# Additional Information Wiring Diagrams

**RET230 HC1/RET230 HCA1 Fan Coil Application**

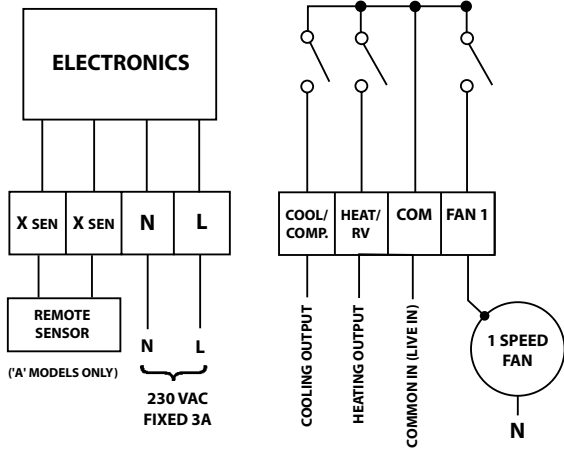

Note: If Heat/Cool/Fan outputs are 230V, link terminals L-COM

**RET230 HC1/RET230 HCA1 Heat Pump Application**

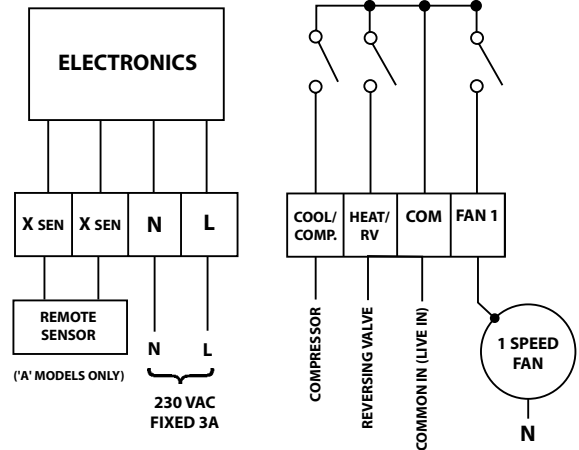

Note: If Heat/Cool/Fan outputs are 230V, link terminals L-COM

**RET230 HC3/RET230 HCA3 (Fan Coil)**

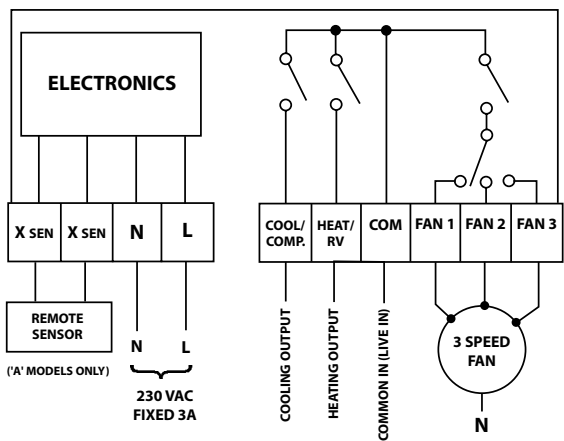

Note: If Heat/Cool/Fan outputs are 230V, link terminals L-COM

**RET230 HC3/RET230 HCA3 (Heat Pump)**

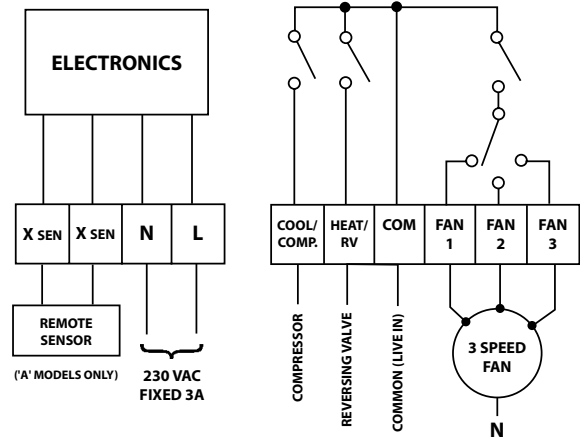

Note: If Heat/Cool/Fan outputs are 230V, link terminals L-COM

**RET230 HCW**

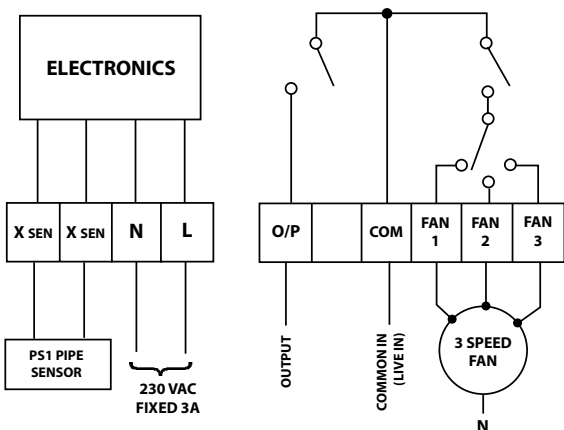

# Additional Information Wiring Diagrams

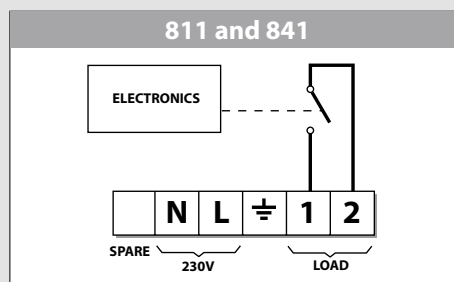
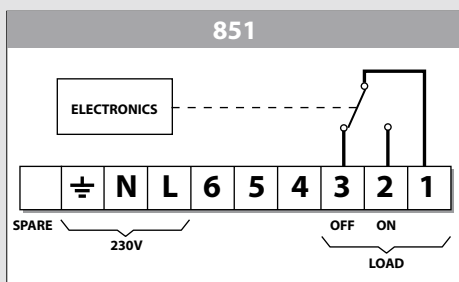
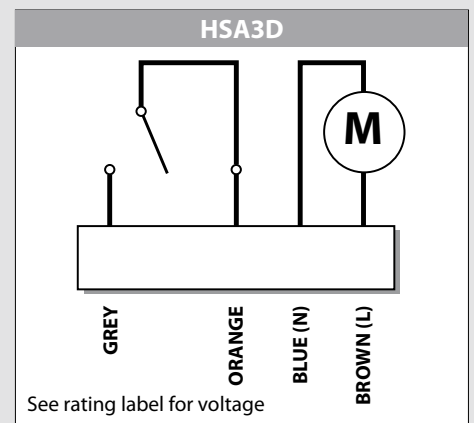
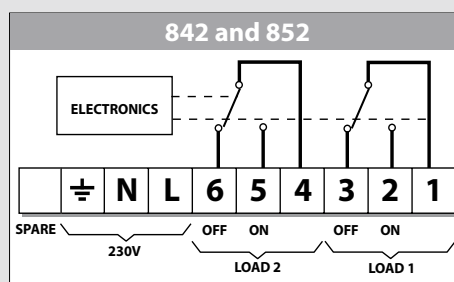
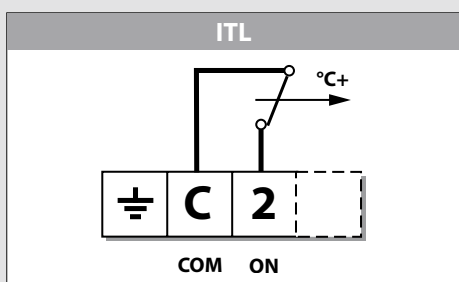
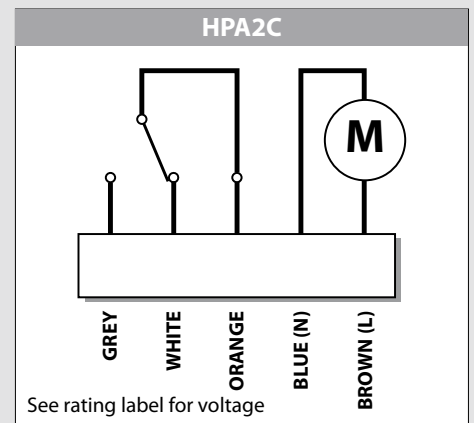
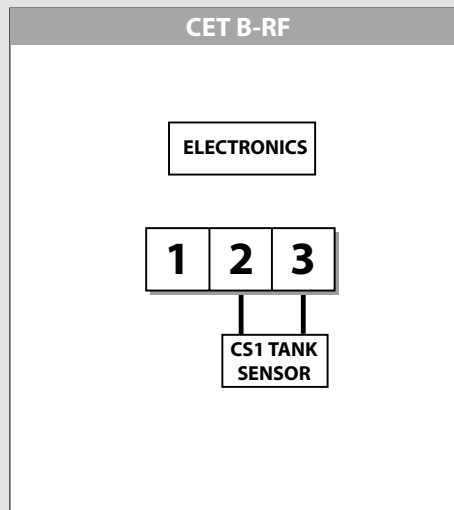
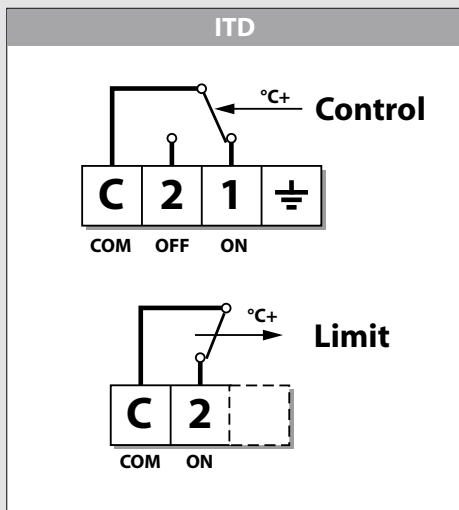
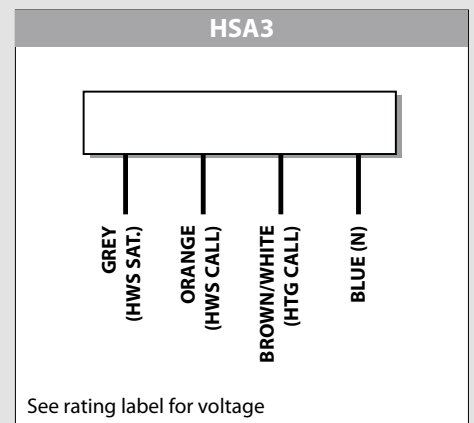
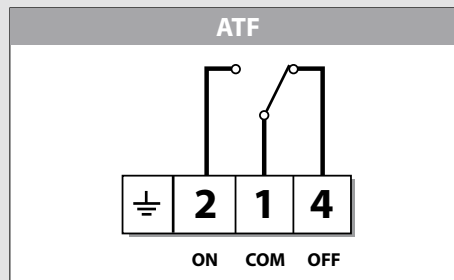
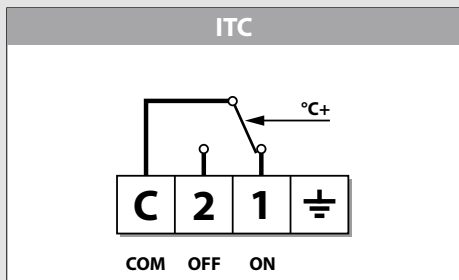
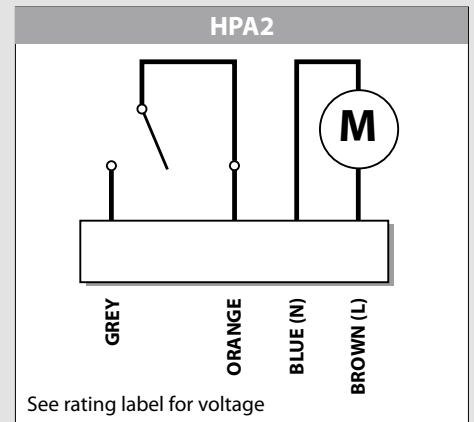
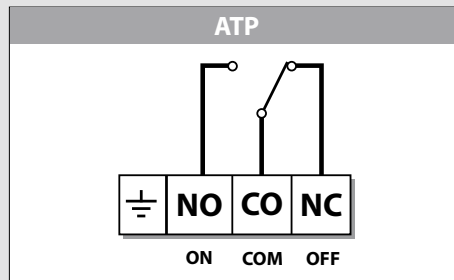
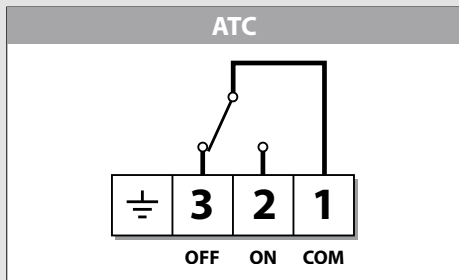

# Additional Information Wiring Diagrams

## FH-BU Wireless Receiver Unit & Wiring Centre

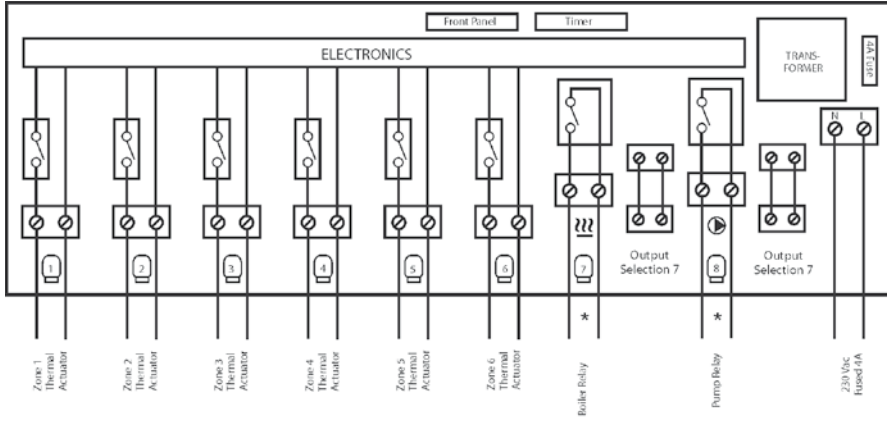

\* Boiler and pump outputs can be re-assigned to thermal actuators - see instructions

## DEVIREG 550

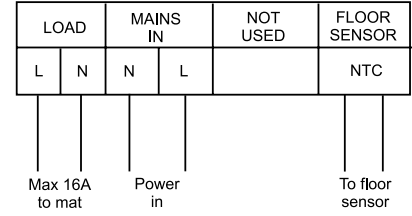

## DEVIREG 130

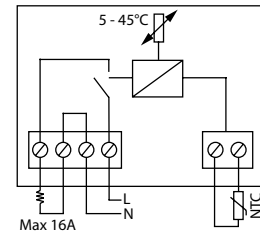

## FH-WC Hard-Wired Wiring Centre

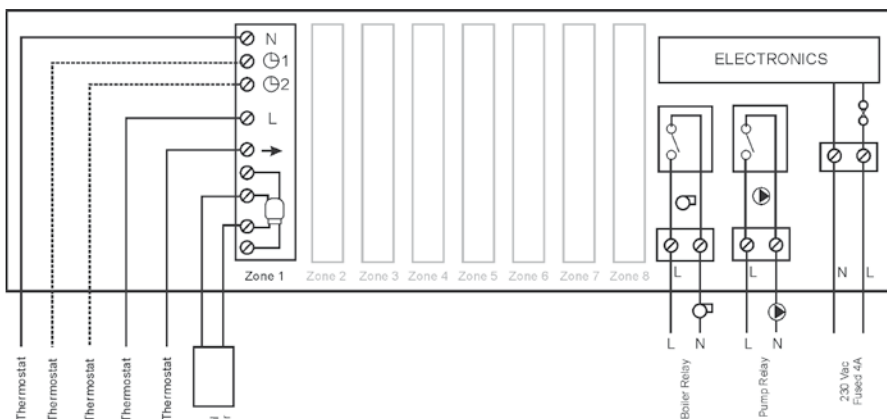

\* For room thermostats with night set-back input connect to either 1 or 2 in FH-WC wiring dependent upon time channel required

## FH-WC & FP975-2H

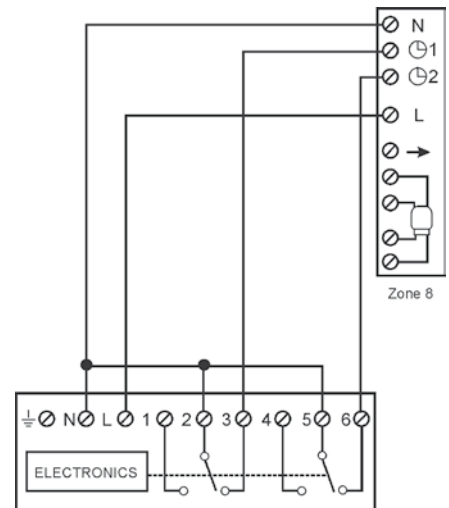

## Room Thermostat Option for FH-WC Hard Wired System

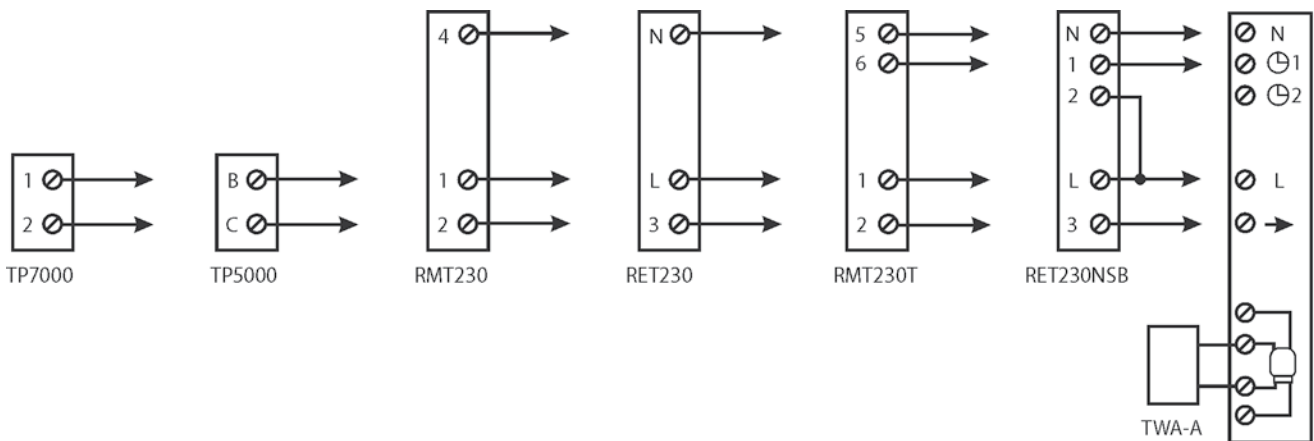

**Zone 1 of FH-WC**  
(repeated for other zones)

# Additional Information Combi Boiler System

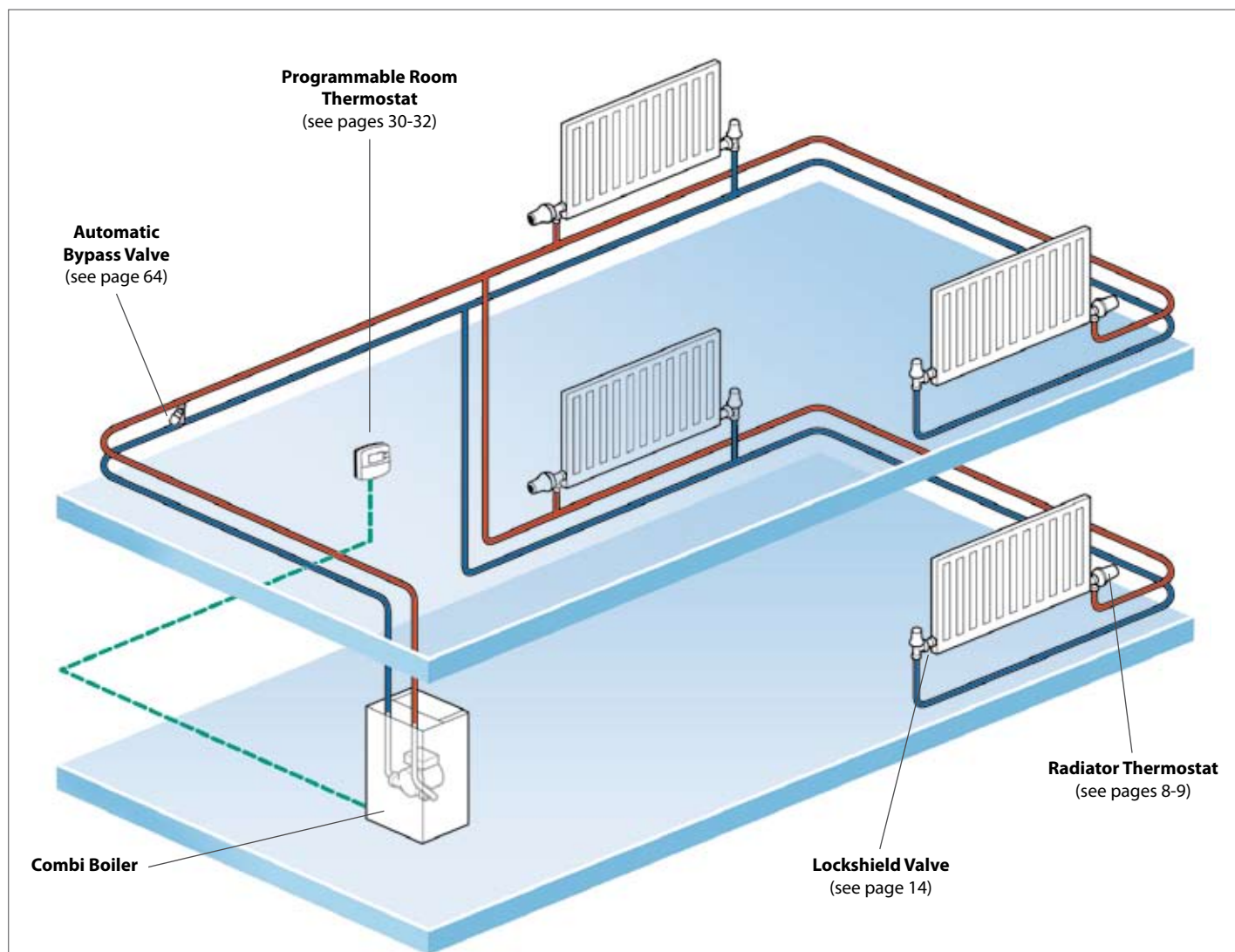

## Wiring Information

### Notes

- 1) Refer to manufacturer's manual for wiring connections to the boiler.
- 2) A radiator thermostat should not be fitted in the room where the room thermostat is located.

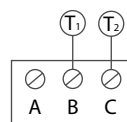
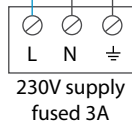
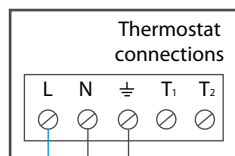

TP5000 Si  
Programmable  
Room Thermostat

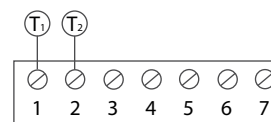

TP7000  
Programmable  
Room Thermostat

Fit either TP5000 Si or TP7000, not both.

# Additional Information Mid-Position Valve System

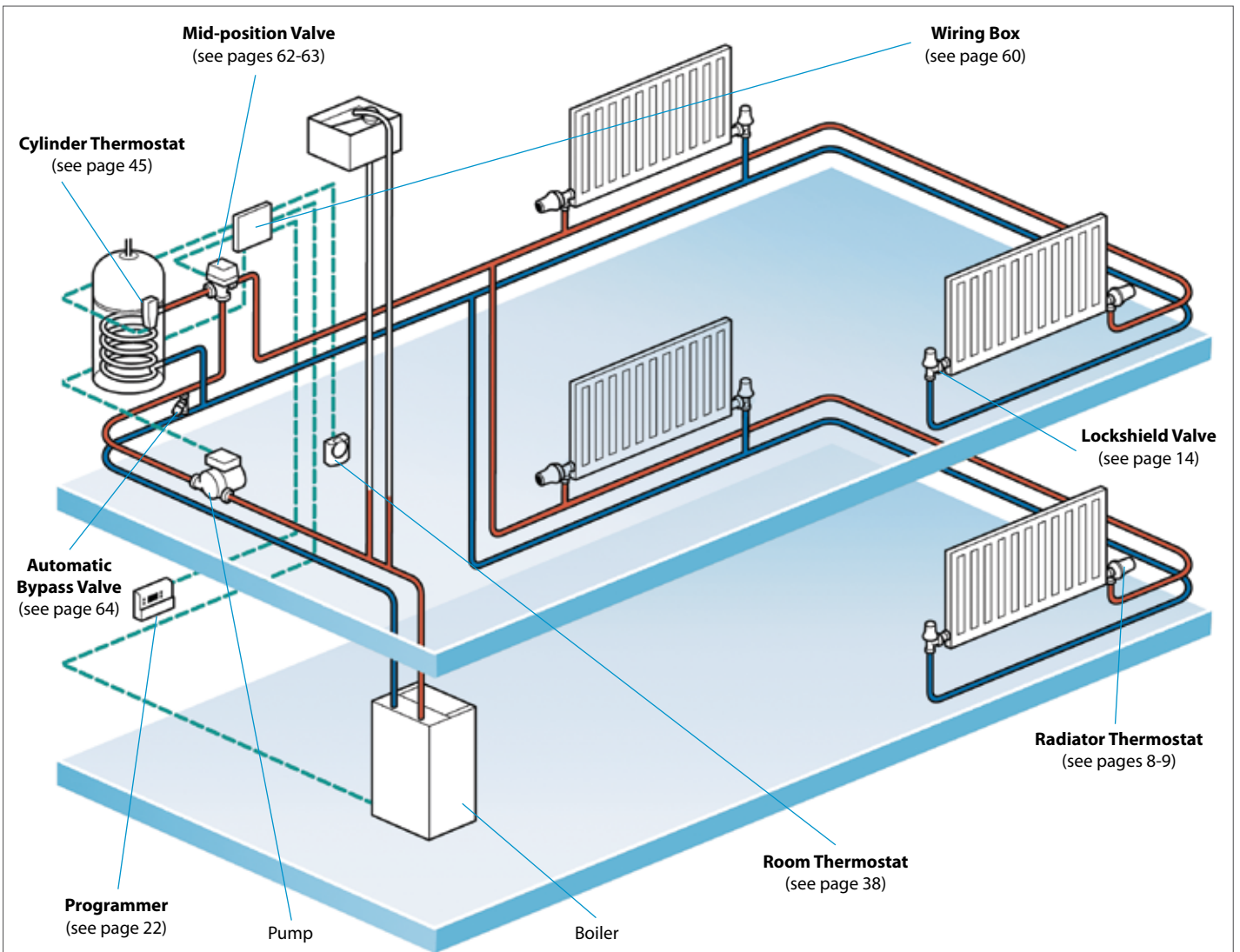

## Wiring Information

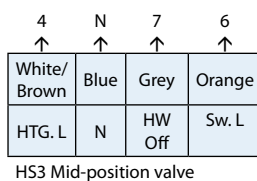
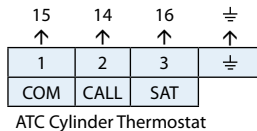
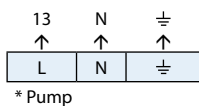
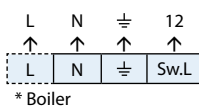
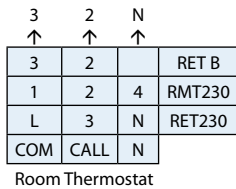
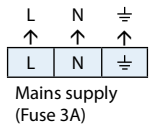
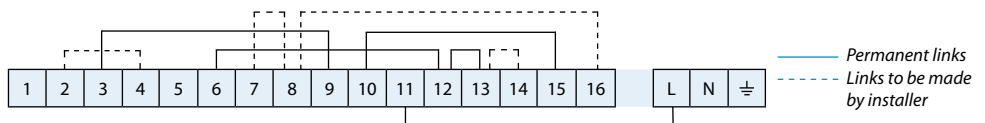

\* Refer to boiler wiring information for boilers with pump overrun.

PROGRAMMER	⊥	N	11	8	10	9	Links
	⊥	↑	↑	↑	↑	↑	
				OFF	ON	ON	
				WATER		HTG	
CP715 Si, FP715-Si & TP9	-	N	L	1	3	4	-
SET3M, SET3E & FP975	-	N	L	3	1	4	L, 2 & 5
SET2E	-	N	L	-	1	4	L-2, 1-5
102 & 102E7	-	N	L	-	1	2	L-3
4033	⊥	7	6	5	4	2	1-6
3060 & 3020P	⊥	7	6	-	4	2	-
TIMESWITCH	<i>Note: When using units below link 11-9 on wiring centre</i>						
103 & 103E7	-	N	L	-	1	-	L-3
TS715 Si	-	N	L	-	4	-	L-1
SET1E	-	N	L	-	4	-	L-5



# Additional Information

## Two Port Zone Valve System

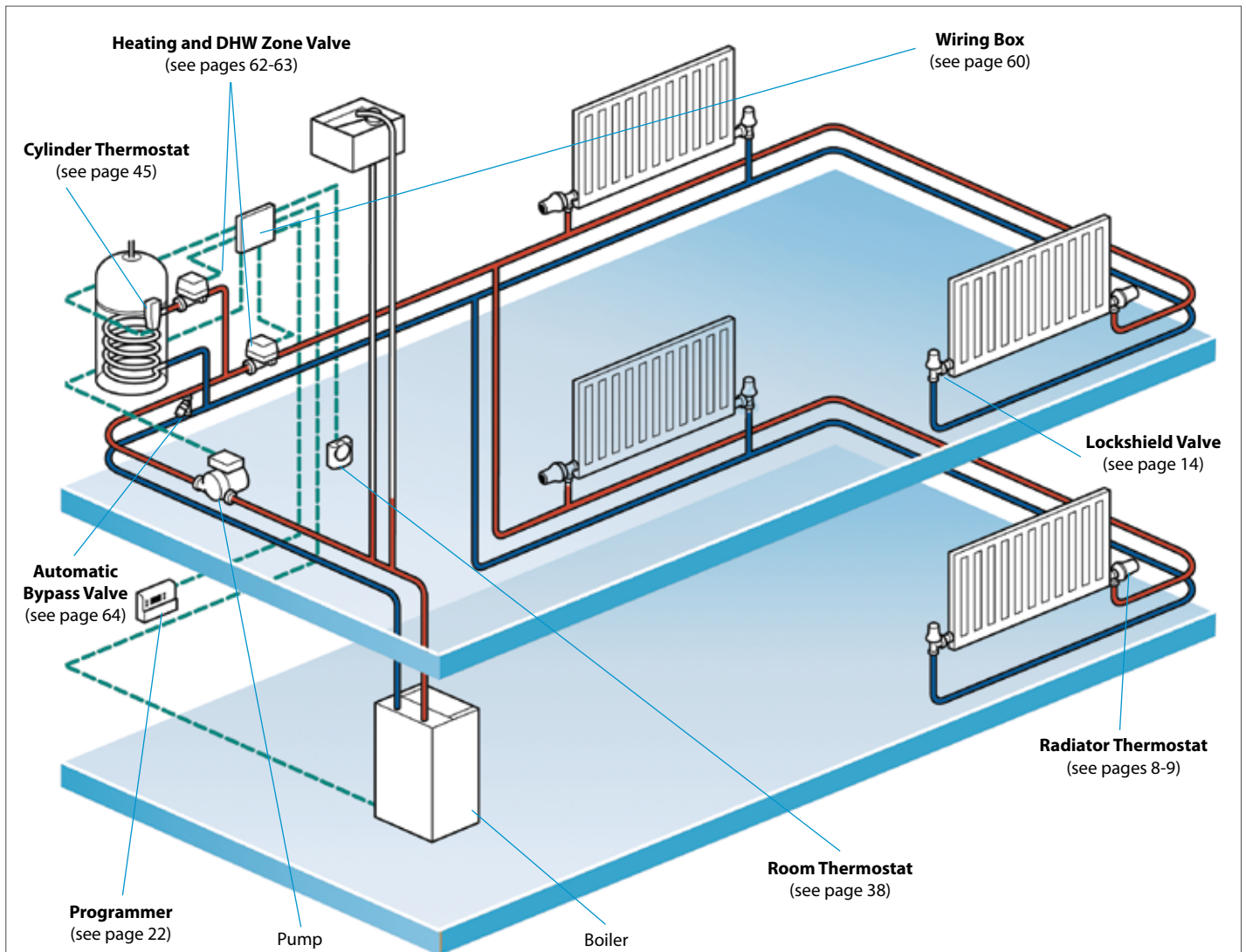

### Wiring Information

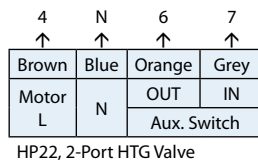
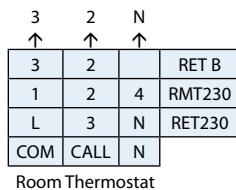
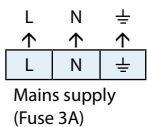
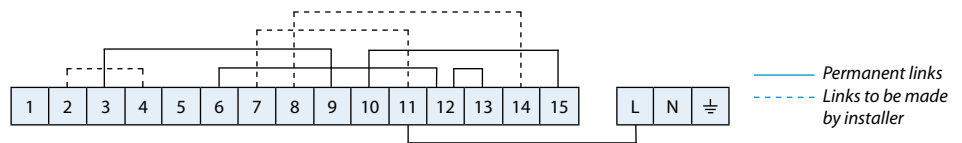

	⊥	N	11	10	9	
	↑	↑	↑	↑	↑	Links
PROGRAMMER	⊥	N	L	ON WATER	ON HTG	
CP715 Si, FP715-Si & TP9	-	N	L	3	4	-
SET3M, SET3E & FP975	-	N	L	1	4	L-2, 1-5
SET2E	-	N	L	1	4	L-2, 1-5
102 & 102E7	-	N	L	1	2	L-3
4033	⊥	7	6	4	2	1-6
3060 & 3020P	⊥	7	6	4	2	-
TIMESWITCH	<i>Note: When using units below link 11-9 on wiring centre</i>					
103 & 103E7	-	N	L	1	-	L-3
TS715 Si	-	N	L	4	-	L-1
SET1E	-	N	L	4	-	L-5

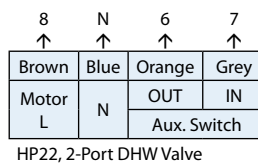
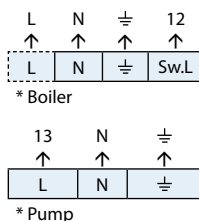
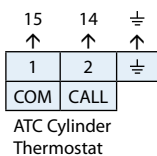

\* Refer to boiler wiring information for boilers with pump overrun.

# Two Port Zone Valve System With Additional Heating Zone

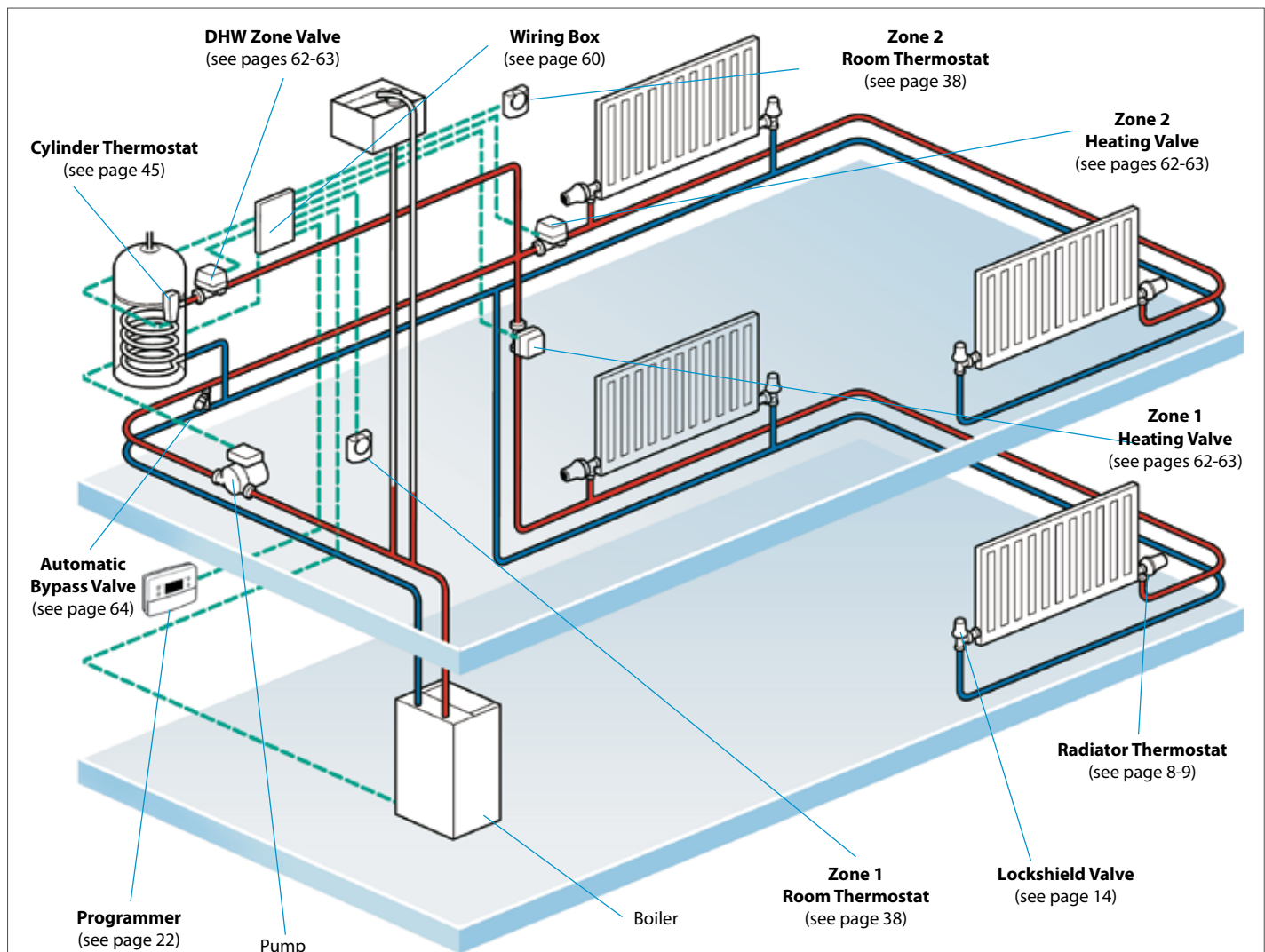

## Wiring Information

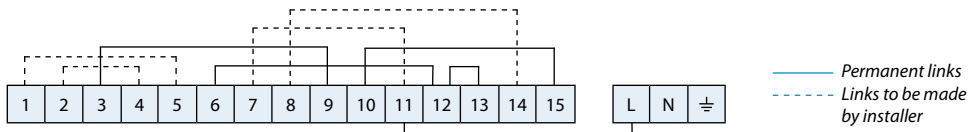

<p>4 N 6 7</p> <p>↑ ↑ ↑ ↑</p> <p>Brown Blue Orange Grey</p> <p>Motor N OUT IN</p> <p>L N Aux. Switch</p> <p>HP22, 2-Port HTG Valve Zone 1</p>	<p>5 N 6 7</p> <p>↑ ↑ ↑ ↑</p> <p>Brown Blue Orange Grey</p> <p>Motor N OUT IN</p> <p>L N Aux. Switch</p> <p>HP22, 2-Port HTG Valve Zone 2</p>	<p>8 N 6 7</p> <p>↑ ↑ ↑ ↑</p> <p>Brown Blue Orange Grey</p> <p>Motor N OUT IN</p> <p>L N Aux. Switch</p> <p>HP22, 2-Port DHW Valve</p>
<p>3 2 N</p> <p>↑ ↑ ↑</p> <p>3 2 RET B</p> <p>1 2 4 RMT230</p> <p>L 3 N RET230</p> <p>COM CALL N</p> <p>Room Thermostat Zone 1</p>	<p>3 1 N</p> <p>↑ ↑ ↑</p> <p>3 2 RET B</p> <p>1 2 4 RMT230</p> <p>L 3 N RET230</p> <p>COM CALL N</p> <p>Room Thermostat Zone 2</p>	<p>15 14</p> <p>↑ ↑</p> <p>1 2</p> <p>COM CALL</p> <p>ATC Cylinder Thermostat</p>
<p>L N</p> <p>↑ ↑</p> <p>L N</p> <p>Mains supply (Fuse 3A)</p>	<p>13 N</p> <p>↑ ↑</p> <p>L N</p> <p>* Pump</p>	<p>L N</p> <p>↑ ↑</p> <p>L N</p> <p>* Boiler</p>

PROGRAMMER	⊕	N	L	ON WATER	ON HTG	Links
	CP715 Si, FP715-Si & TP9	-	N	L	3	
SET3M, SET3E & FP975	-	N	L	1	4	L, 2 & 5
SET2E	-	N	L	1	4	L-2, 1-5
102 & 102E7	-	N	L	1	2	L-3
4033	⊕	7	6	4	2	1-6
3060 & 3020P	⊕	7	6	4	2	-
<b>TIMESWITCH</b>						
<i>Note: When using units below link 11-9 on wiring centre</i>						
103 & 103E7	-	N	L	1	-	L-3
TS715 Si	-	N	L	4	-	L-1
SET1E	-	N	L	4	-	L-5

\* Refer to boiler wiring information for boilers with pump overrun.

# Radio Frequency (RF) Control Packs and Wiring

## Wiring Information 3 Port

— Permanent links  
- - - Links to be made by installer

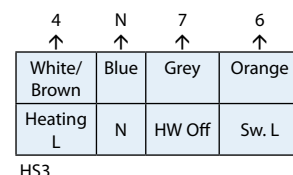
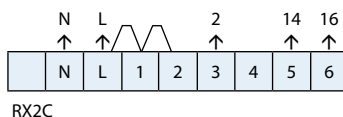
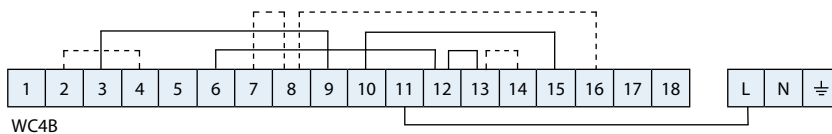

RX Channel Assignment			
Channel 1	Heating	Channel 2	Hot Water

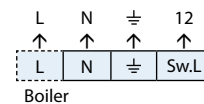
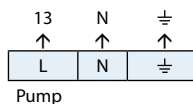
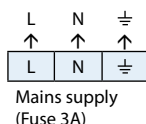

## Ordering Information

3 Port Valve Pack - wireless programmable heating and hot water thermostats						
Description	Code No	Room Thermostat	Hot Water Thermostat	Receiver	Wiring Centre	2 Port Zone Valves <sup>(1)</sup>
Pack with 7 day programming options	087N742100	TP7000-RF	WP75-RF	RX2C	WC4B	No valves
Pack with 7 day programming options	087N742200	TP7000-RF	WP75-RF	RX2C	WC4B	1 x HS3
Pack with 5/2 day programming options	087N742400	TP5000-RF Si	WP75-RF	RX2C	WC4B	1 x HS3

Note: (1) All valves are 22mm size

## Wiring Information 2 Port

— Permanent links  
- - - Links to be made by installer

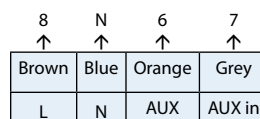
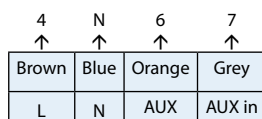
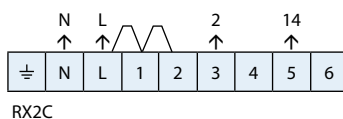
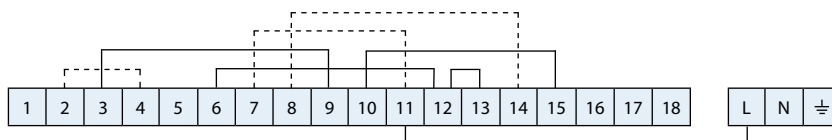

RX Channel Assignment			
Channel 1	Heating	Channel 2	Hot Water

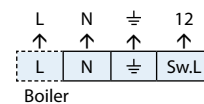
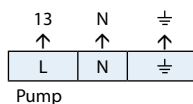
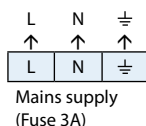

## Ordering Information

2 Port Valve Pack - wireless programmable heating and hot water thermostats						
Description	Code No	Room Thermostat	Hot Water Thermostat	Receiver	Wiring Centre	2 Port Zone Valves <sup>(1)</sup>
Pack with 7 day programming options	087N737600	TP7000-RF	WP75-RF	RX2C	WC4B	No valves
Pack with 7 day programming options	087N742300	TP7000-RF	WP75-RF	RX2C	WC4B	2 x HP22
Pack with 5/2 day programming options	087N742500	TP5000-RF Si	WP75-RF	RX2C	WC4B	2 x HP22

Note: (1) All valves are 22mm size

For additional information please refer to the Danfoss Wireless Controls Catalogue (Part number 662)

# Additional Information

## Hard Wired Underfloor Heating System

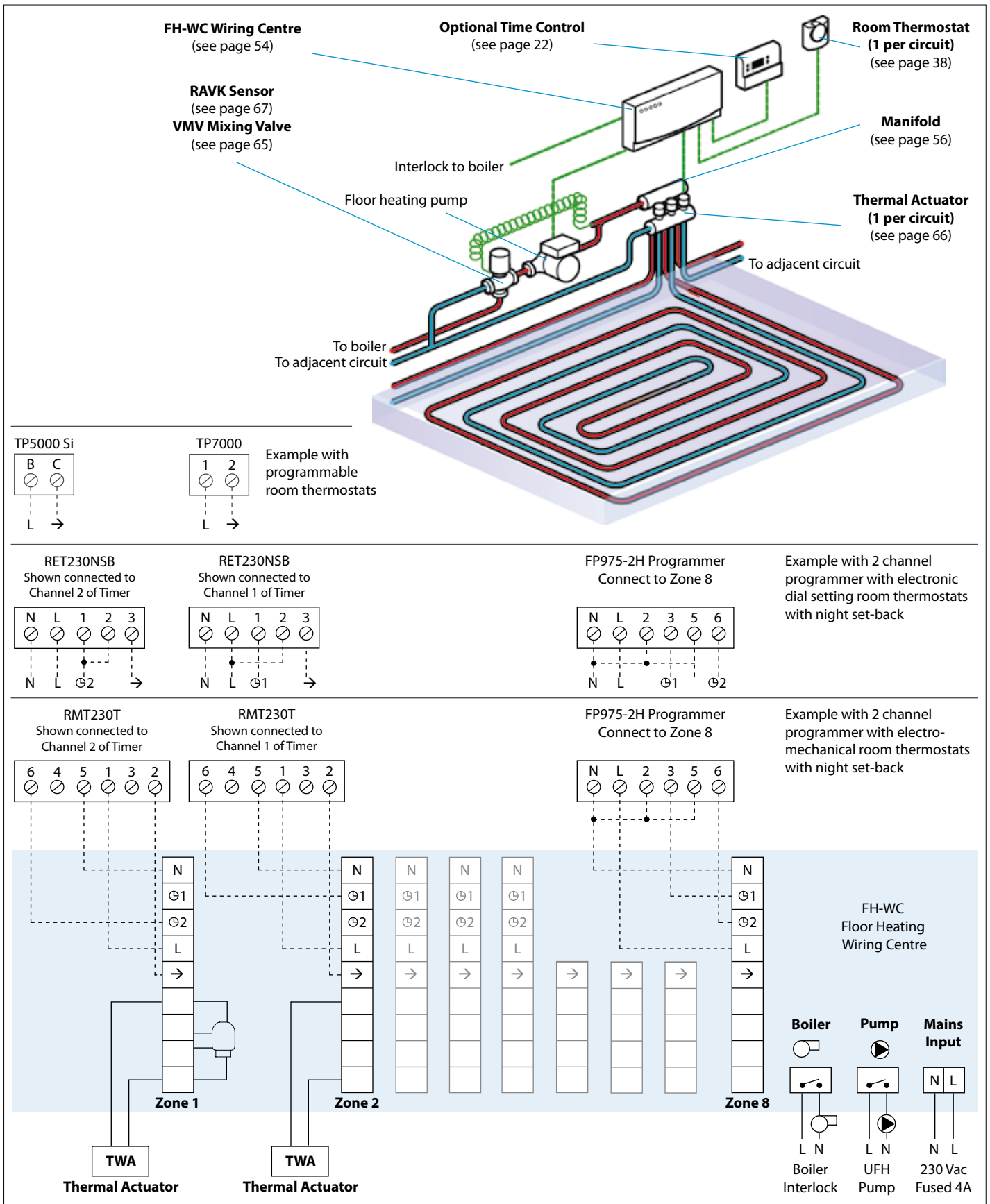

# Additional Information

## Wireless Underfloor Heating System

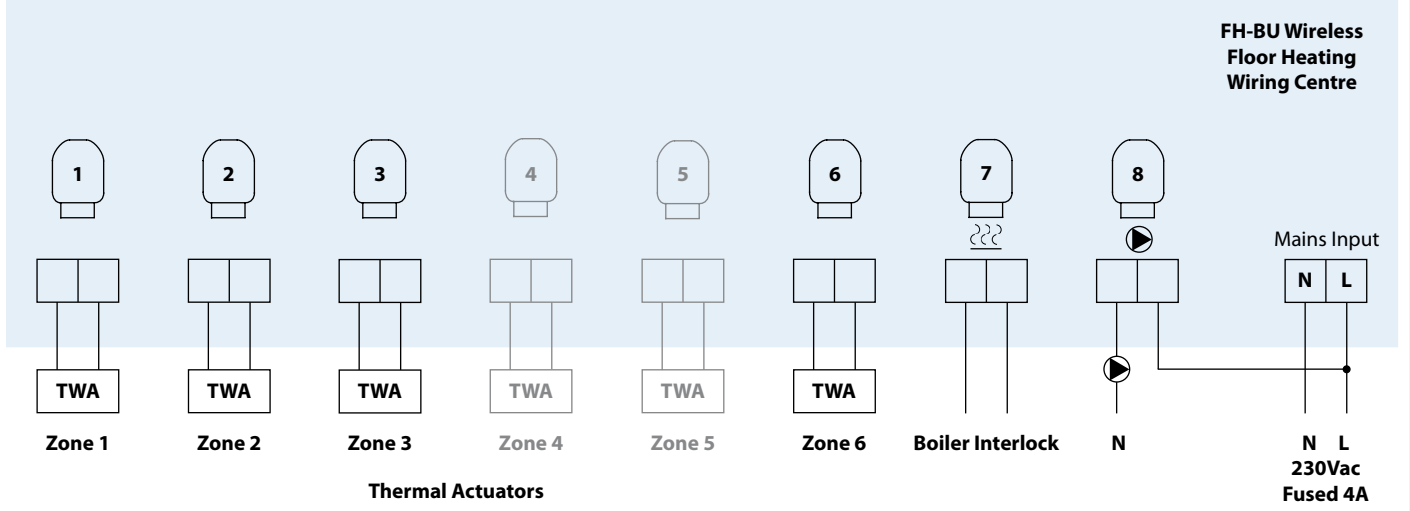
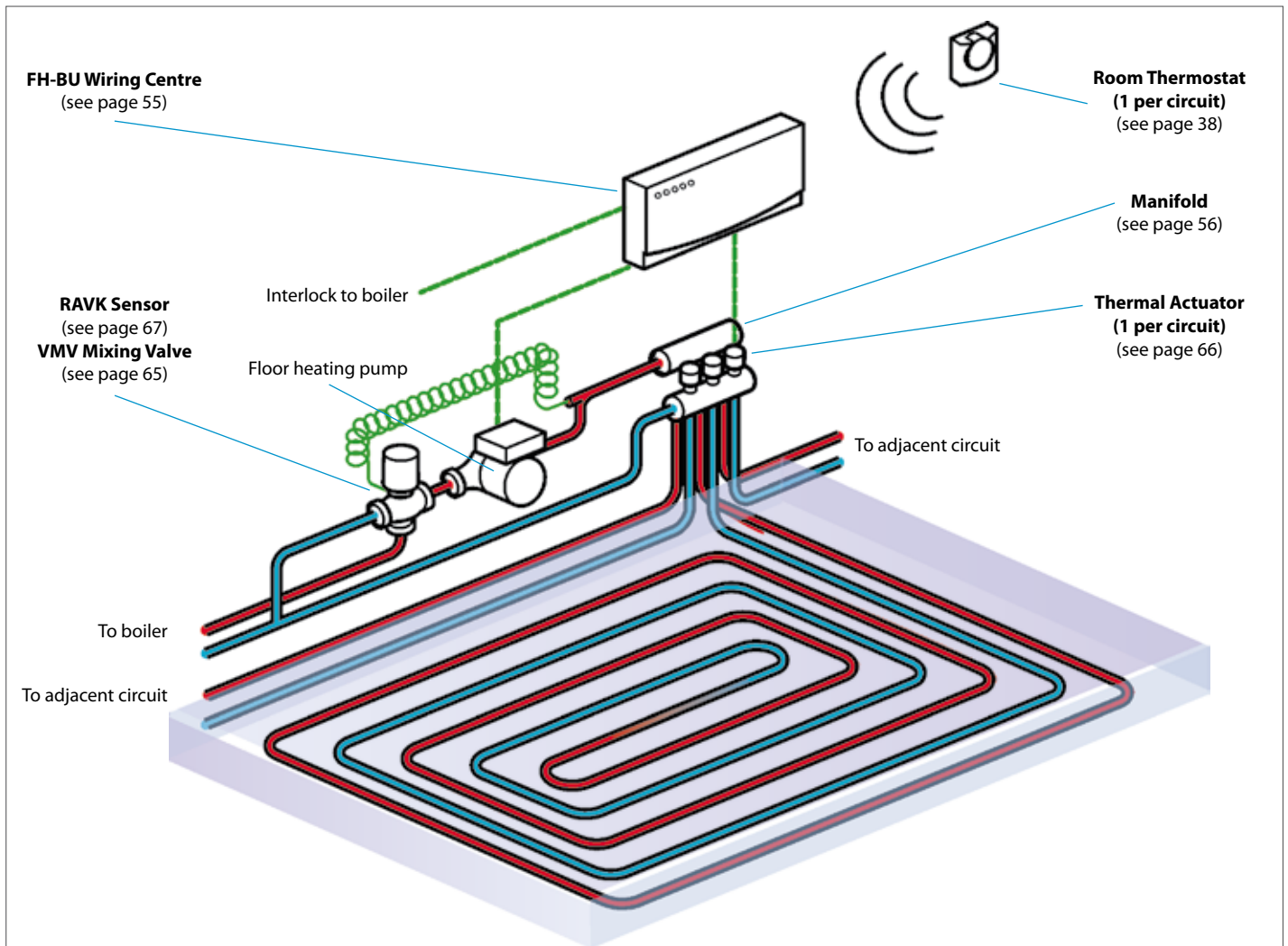



# Radiator Thermostat Selection and Cross Reference Chart

**START**

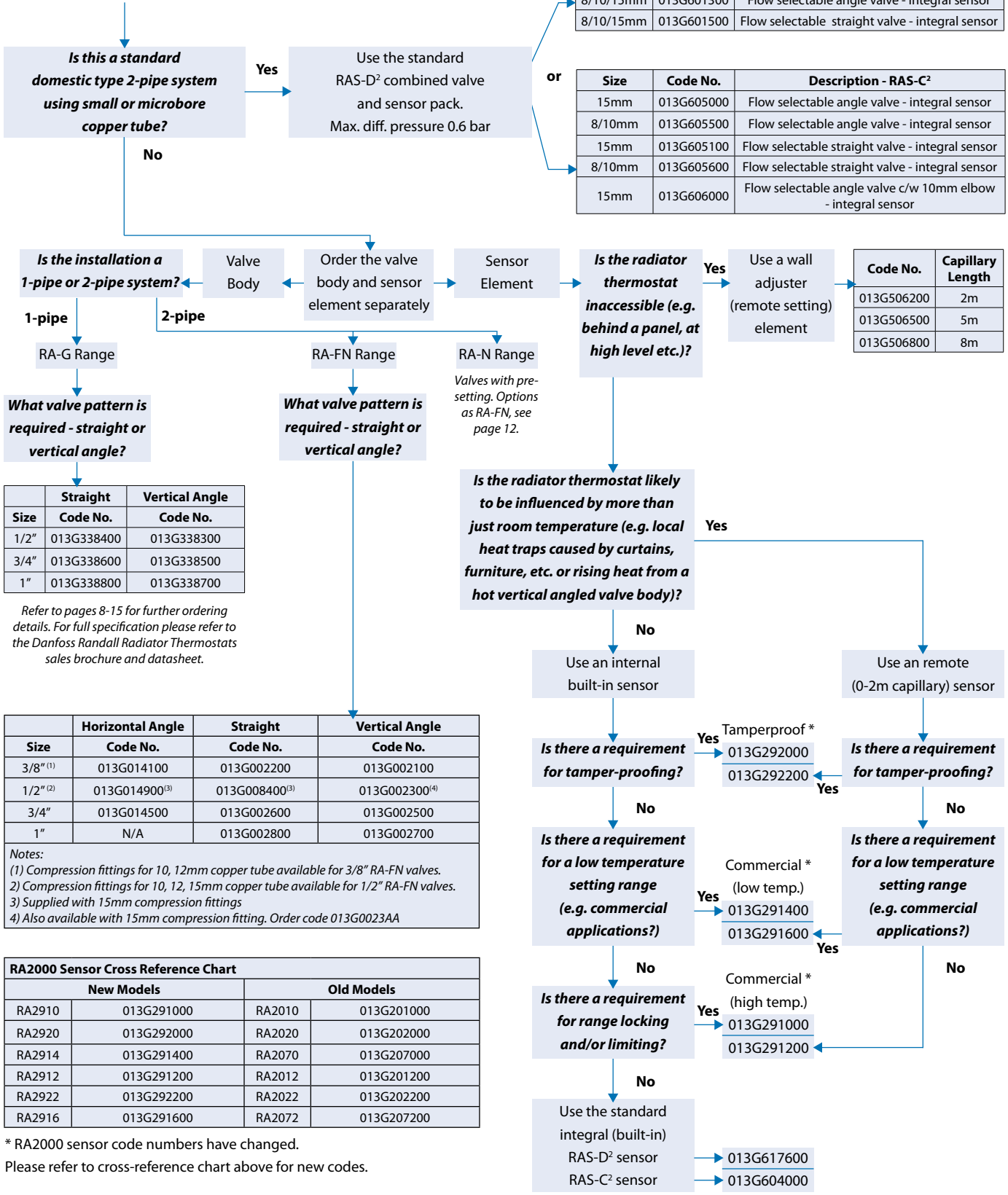

# Commercial Radiator Thermostat Selection Guide

- Approved combination, refer to notes for any restrictions/advice
- 1 Mount sensor horizontally
- 2 Consider use of remote sensor to improve performance
- 3 Remote sensor is recommended
- 4 Valve body flow selector must be commissioned

Description	Built-in Sensors			Remote Sensors (0-2m)			2/5/8m Wall Adjusters
	Standard	Low Temp.	Tamperproof	Standard	Low Temp.	Tamperproof	
<b>Symbol</b>							
<b>Model</b>	RA2910	RA2914	RA2920	RA2912	RA2916	RA2922	RA5062, RA5065, RA5068
<b>Codes</b>	013G291000	013G291400	013G292000	013G291200	013G291600	013G292200	013G506200 013G506500 013G506800
<b>Temp. Range</b>	5-26°C	5-22°C	5-26°C	5-26°C	5-22°C	5-26°C	6-28°C

Valve Options						Sensor Options						
Symbol	Size	Standard Valves		Valves with pre-setting								
		Type	Code No.	Type	Code No.							
2-Pipe System		8/10mm	RA-FS 15	013G628300	N/A		• 4	• 4	• 4	• 4	• 4	• 4
		15mm	RA-FS 15	013G628100	N/A							
		3/8"	RA-FN 10	013G002200	RA-N 10	013G003200						
		1/2"	RA-FN 15	013G002400	RA-N 15	013G003400						
		1/2"/15mm	RA-FN 15	013G008400	RA-N 15	013G0034AA	• 1	• 1	• 1	•	•	•
		3/4"	RA-FN 20	013G002600	RA-N 20	013G003600						
		1"	RA-FN 25	013G002800	RA-N 25	013G003800						
		3/8"	RA-FN 10	013G002100	RA-N 10	013G003100						
		1/2"	RA-FN 15	013G002300	RA-N 15	013G003300						
		1/2"/15mm	RA-FN 15	013G0023AA	RA-N 15	013G0033AA	• 2	• 3	• 2	•	•	•
		3/4"	RA-FN 20	013G002500	RA-N 20	013G003500						
		1"	RA-FN 25	013G002700	RA-N 25	013G003700						
3/8"		RA-FN 10	013G014100	RA-N 10	013G015100							
1-Pipe System		1/2"/15mm	RA-FN 15	013G014900	RA-N 15	013G015300	•	•	•	•	•	•
		3/4"	RA-FN 20	013G014500	RA-N 20	013G015500						
		1/2"	RA-G 15	013G338400	N/A							
1-Pipe System		3/4"	RA-G 20	013G338600	N/A		• 1	• 1	• 1	•	•	•
		1"	RA-G 25	013G338800	N/A							
		1/2"	RA-G 15	013G338300	N/A							
		3/4"	RA-G 20	013G338500	N/A		• 2	• 3	• 2	•	•	•
1-Pipe System		1"	RA-G 25	013G338700	N/A							

# Literature Service

## Order Form

Product Range	Type	Part No.	Quantity
Domestic Product Selection Guide	Catalogue	028	
Wireless Control Packs	Catalogue	662	
Underfloor Heating Product & System Guide	Catalogue	438	
RA2000 Commercial Radiator Thermostats	Catalogue	410	
Commercial Product Selection Guide	Catalogue	026	
<b>Radiator Thermostats</b>			
RAS-C <sup>2</sup> Revolver Radiator Thermostats, incl. push-fit versions	Sales Leaflet*	250	
RAS-D <sup>2</sup> Domestic Revolver Radiator Thermostats, incl. push-fit versions	Sales Leaflet*	336	
RA2000 Commercial Radiator Sensors	Datasheet	VDVBE122	
RA-FN and RA-G Commercial Valve Bodies	Datasheet	VD51Q102	
RA-N Commercial Valve Bodies	Datasheet	VD51G802	
RLV-D Domestic Lockshield Valves, including push-fit versions	Datasheet	VD35E202	
RLV Commercial Lockshield Valves	Datasheet	VD35D102	
H Pieces and Sensors	Datasheet	VD35C102	
Bathroom Solutions - RA-URX Towel Rail	Sales Leaflet	580	
Bathroom Solutions - RA-URX Towel Rail	Datasheet	VDUVV202	
Replacement Sensors RA-V & RA-VL	Datasheet	VDULY102	
<b>Time Controls</b>			
MK18 Time Controls - TS715 Si, CP715 Si & FP715 Si	Sales Leaflet	334	
MK18 Time Controls, Compatibility Guide	Sales Leaflet	196	
FP975 Replacement Time Controls	Datasheet	208	
GP Time Controls - 102, 102E7, 103 & 103E7	Sales Leaflet	582	
Set Range - SET1E, SET2E, SET3E & SET3M	Sales Leaflet	188	
MK3 Programmers - 3020P, 3060 & 4033	Datasheet	040	
Commercial Time Controls - MK8	Sales Leaflet	606	
<b>Electric Thermostats</b>			
RT51 and RT51-RF Digital Thermostats	Sales Leaflet*	144	
TP4000 Programmable Room Thermostats	Sales Leaflet*	238	
TP5000 Si Programmable Room Thermostats	Sales Leaflet*	296	
TP7000 Programmable Room Thermostats	Sales Leaflet*	594	
HC6000 Heat/Cool Thermostats	Sales Leaflet*	596	
TP9000 Programmable Thermostat with Hot Water Time Control	Sales Leaflet*	692	
WP75RF Programmable Hot Water Thermostat	Sales Leaflet*	282	
RMT/RET Room Thermostats	Sales Leaflet*	584	
RET230 Electronic Room Thermostats with Function Switches	Sales Leaflet*	592	
RET230 HC and HCW Heat/Cool Thermostats	Datasheet	660	
RET B Battery Room Thermostats plus RF versions	Sales Leaflet*	588	
RET-MD and RET-M Room Thermostats	Sales Leaflet*	590	
RET230P Electronic Room Thermostat	Datasheet	752	
FlatStat Flush Mount Thermostat	Sales Leaflet*	720	
ORT Modulating Thermostats	Sales Leaflet*	150	
Cylinder, Pipe & Frost Thermostats - ATC, ATP, ATF and RET230F	Datasheet	374	
Immersion Thermostats - ITC, ITL and ITD	Datasheet	374	
<b>Underfloor Heating Controls</b>			
Underfloor Heating Product and System Guide	Catalogue	438	
DeviMat Electric Underfloor Warming	Sales Leaflet*	628	
DeviDry Electric Underfloor Warming	Sales Leaflet	812	
DeviLink and DeviReg Thermostat Range	Sales Leaflet	884	
DeviClear, DeviFoil and DeviRail	Sales Leaflet	894	
CF2 2-Way Wireless Floor Heating Control System	Sales Leaflet*	882	
FH-WC Hard Wired Zone Control	Datasheet	620	
FH-BU Wireless Zone Control	Datasheet	622	
FHV Valves for Underfloor Heating	Sales Leaflet*	476	
FHF-F Floor Heating Manifold	Datasheet	VDUDO112	
<b>Motorised Valves and Other Controls</b>			
Control Packs	Sales Leaflet*	120	
Wiring Centre WC4B	Instructions	39917	
Wireless Controls Packs WP75-RF	Datasheet	408	
H Series Motorised Valves	Sales Leaflet*	192	
Domestic Bypass Valves AVDO	Datasheet	062	
Domestic Bypass Valves ARV22	Datasheet	380	
Thermal Actuators TWA	Datasheet	VDSAP112	
AB-QM Balancing Valves	Datasheet	VDA2W712	
AB-QM Balancing Valves	Sales Leaflet	VBA2Z102	
Thermostatic Cylinder Controls RAVI	Datasheet	240	
Climate Control Range - FEK, FEV and FED	Catalogue	346	

**Ordering Literature**

To obtain copies of individual product sales leaflets and datasheets please photocopy this page and complete your personal details and the literature quantities you require and fax this form to

**UK 0845 1217 531**  
**Ireland 1800 930 242**

Company Name: \_\_\_\_\_

Address \_\_\_\_\_

\_\_\_\_\_

\_\_\_\_\_

Postcode \_\_\_\_\_

Contact Name \_\_\_\_\_

\_\_\_\_\_

**Datasheets**

\* Denotes that datasheets are also available. Please use the space below to indicate which datasheet you would like to order.

Datasheet	Quantity



## Warranty and Returns Policy

Danfoss offers a no quibble two year warranty from date of manufacture on all products with the exception of DeviMat and cables which carry a 10 year warranty and DeviDry which has a 5 year warranty.

Whatever the nature of the fault or defect, i.e. manufacturing or installer, Danfoss will give a full credit for the product on a one-for-one basis.

All 'in warranty' returns are fully tested to original manufacturing specification. Reports are available within 10 working days.

The warranty expiry details are clearly marked on all products. This warranty does not cover the associated costs of replacing the product in the field with the exception of for DeviMats and DeviCable.

### **Customer Returns Procedure:**

- Customer requests a RMA number from Customer Services - Tel: 0845 1217 502
- Customer confirms details in writing to Customer Services and returns products to Danfoss Randall Ltd, Ampthill Road, Bedford MK42 9ER
- Products are checked and allocated individual identification.
- All products within warranty are tested and reports are generated.

Full details on the warranty and returns policy are available on request.



**No Quibble**

**Returns Policy**

on all products in the range.



**Danfoss Randall Ltd**

Ampthill Road, Bedford, MK42 9ER  
Tel: 0845 1217 400  
Fax: 0845 1217 515  
Email: [danfosrandall@danfoss.com](mailto:danfosrandall@danfoss.com)  
Website: [www.danfoss-randall.co.uk](http://www.danfoss-randall.co.uk)

---

Danfoss can accept no responsibility for possible errors in catalogues, brochures, and other printed material. Danfoss reserves the right to alter its products without notice. This also applies to products already on order provided that such alterations can be made without subsequent changes being necessary in specifications already agreed. All trademarks in this material are property of the respective companies. Danfoss and the Danfoss logotype are trademarks of Danfoss A/S. All rights reserved.

---