

Installation and User Guide



living eco[®] Electronic Radiator Thermostat

Installation Guide

1. Installation

1.1 Identify your living eco® thermostat 4

1.2 In the package 4

1.3 Overview of valve adapters 5

1.4 Installing the right adapter 6

1.5 Inserting the batteries 7

1.6 Using the buttons 7

1.7 Setting time and date for the first time 8

1.8 Installing living eco® 8

1.9 Automatic adjustments 9

1.10 Removing living eco® 9

1.11 Resetting living eco® to default settings 10

1.12 Removing an adapter from living eco® 10

2. Technical specifications 11



Scan this QR code with your smartphone and go directly to the living eco® Installation video on YouTube.



Scan this QR code with your smartphone and go directly to the living eco® Programming video on YouTube.

User Guide

3. Display and menus

3.1	Home Screen	12
3.2	Programme menu.....	12
3.3	Function menu.....	13
3.4	Advanced menu	14

4. Temperature and programme settings

4.1	Setting the comfort temperature	15
4.2	Default programme settings	16
4.3	Adjusting a setback period	17
4.4	Creating a new setback period.....	18
4.5	Deleting a setback period	19
4.6	Creating a Travel programme	20
4.7	Override a Travel programme (early return)	21
4.8	Changing an existing Travel programme	21
4.9	Deleting a Travel programme	22
4.10	Creating a Frost Protection programme	22

5. Additional settings

5.1	Setting the time	23
5.2	Limiting the temperature setting range	23
5.3	Deactivating automatic daylight saving time.....	24
5.4	Child Lock	24
5.5	Setting the Heating Control	25
5.6	Open-window function.....	25
5.7	Adjusting to radiator/room conditions	26
5.8	Automatic valve exercising	26
5.9	Deactivating intelligent Control (Forecast)	27

6. Safety precautions..... 27

7. Disposal

Pay a visit to the living web-site, where you find a lot of additional information:
animations and videos, a FAQ section, literature and much, much more

living.danfoss.eu

1. Installation

1.1 Identify your *living eco*® thermostat

living eco® comes in several versions to meet the demands of different markets.

You identify your version by the code number on the box label.

Adapters for a range of different valves types are available as accessories, see chapter 1.3.



Code no.	Version characteristics	Quick guide languages
014G0050	Incl. pre-mounted RA adapter	UK, DE, DK, NL, FR, PL, SE, FI
014G0051	Incl. RA + M30 x 1.5 adapters	UK, DE, DK, NL, FR, PL, SE, FI
014G0052	Incl. RA + M30 x 1.5 adapters	UK, CZ, SK, RU, TR, HU, HR, SI
014G0064	Incl. RA + M30 x 1.5 adapters, Forecast disabled as default	UK, DE, DK, NL, FR, PL, SE, FI

1.2 In the package

living eco® **014G0050** is supplied with a pre-mounted adapter for Danfoss RA valves, two alkaline AA batteries, a 2 mm Allen key and a Quick Guide in languages English, German, Danish, Dutch, French, Polish, Swedish and Finnish.

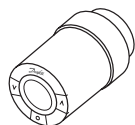

living eco® sensor

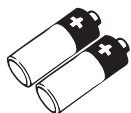

Alkaline AA batteries

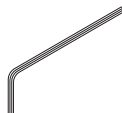

Allen key, 2 mm



Quick Guide and "Hanger"

living eco® **014G0051**, **014G0052** and **014G0064** are supplied with adapters for Danfoss RA valves and valves with M30 x 1.5 (K) connections, two alkaline AA batteries, a 2 mm Allen key and a Quick Guide in English, German, Danish, Dutch, French, Polish, Swedish and Finnish (014G0051 and 014G0064) or in English, Czech, Slovak, Russian, Turkish, Hungarian Croatian and Slovenian (014G0052).

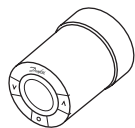

living eco® sensor



Adapter for
RA valves



Adapter for
M30 x 1.5 (K) valves

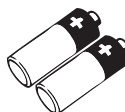

Alkaline
AA batteries

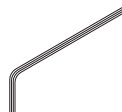





Allen key, 2 mm

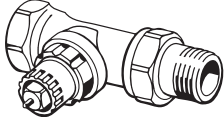

Quick Guide
and "Hanger"

1.3 Overview of valve adapters

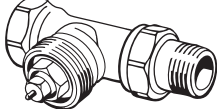
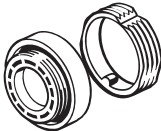
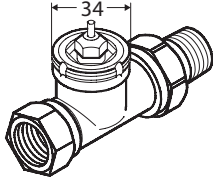
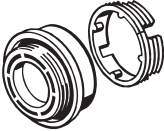
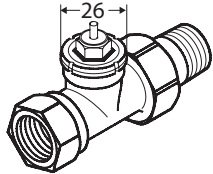
Adapters for a wide range of different valve types are available as accessories.

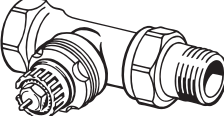
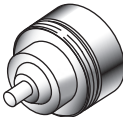
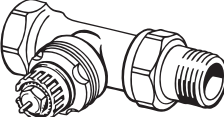
Adapter type	Code no.	Adapter	Valve
For Danfoss RA valves	014G0251		
For M30 x 1.5 (K) valves	014G0252		
For Danfoss RAV valves	014G0250		
For Danfoss RAVL valves			
For Danfoss RTD valves	014G0253		
For M28 valves: - MMA - Herz - Orkli - COMAP	014G0255 014G0256 014G0257 014G0258		

1.4 Installing the right adapter

Adapter for RA valves (pre-mounted on 014G0050)

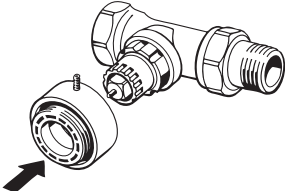
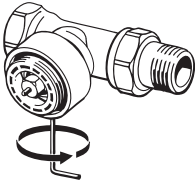
<p>1.</p>  <p>Place the RA adapter on the valve as shown.</p>	<p>2.</p>  <p>Tighten the adapter with the 2 mm Allen key.</p>
--	---

Adapter for M30 x 1.5 (K) valves

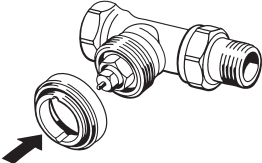
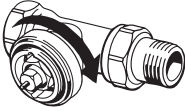
<p>1.</p>  <p>Place the K adapter on the valve as shown.</p>	<p>2.</p>  <p>Hand-tighten the K adapter (max. 5 Nm).</p>
---	--

Adapter for RAV valves (accessory)

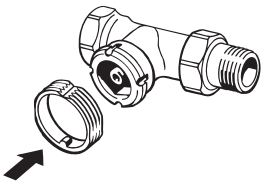
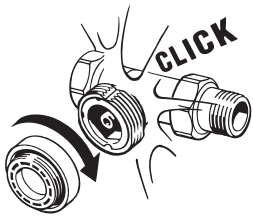
<p>1.</p>  <p>Click the inner adapter on the valve.</p>	<p>2.</p>  <p>Hand-tighten the outer adapter (max. 5 Nm).</p>
---	---

Adapter for RAVL valves (accessory)

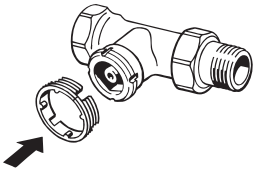
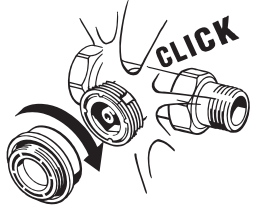
<p>1.</p>  <p>Click the inner adapter on the valve.</p>	<p>2.</p>  <p>Hand-tighten the outer adapter (max. 5 Nm).</p>
--	--

Adapter for RTD valves (accessory)

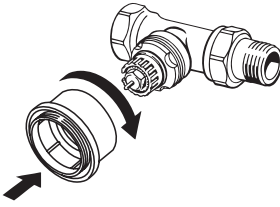
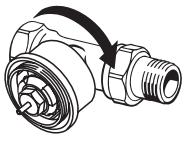
<p>1.</p>  <p>Place the RTD adapter on the valve as shown.</p>	<p>2.</p>  <p>Hand-tighten the RTD adapter (max. 5 Nm).</p>
---	--

Adapters for M28 valves (accessories)

Please follow the instructions supplied with the valve adapter for the specific M28 valve.

1.5 Inserting the batteries

Remove the battery cover and insert two AA batteries. Make sure the batteries are correctly oriented.

Rechargeable batteries **must not** be used.

When replacing batteries the programme settings will be preserved, but after two minutes the settings for time and date are reset.

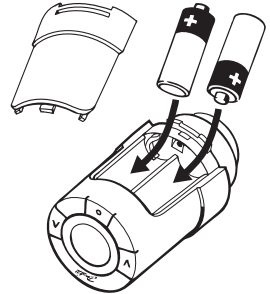

The low battery symbol  is displayed approx. one month before the batteries run out.

After approx. two weeks the  symbol will flash 14 times from 19:00 to 21:00 hrs.

Before the batteries run out *living eco*® will leave the valve in Frost Protection position to protect the heating system from damage.

1.6 Using the buttons







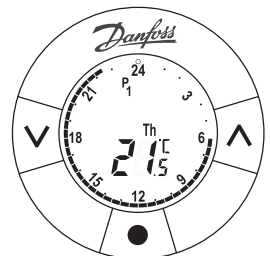



living eco® has two arrow buttons  which allow you to navigate the display and the menus and to set the temperature.

The dot button  is used to select and confirm.







If the display is off, press either button to activate the display.

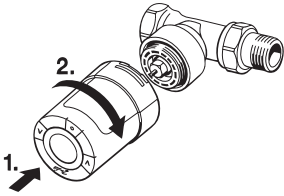
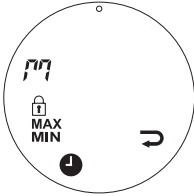

1.7 Setting time and date for the first time

<p>1.</p>  <p>When the batteries are installed the time flashes on the display - 23:59.</p> <ol style="list-style-type: none"> Set hours with , press  to confirm. Set minutes with , press  to confirm. Set date with , press  to confirm. 	<p>2.</p>  <p>When  flashes, press  to confirm your settings.</p> <p>The display now switches to the Home Screen (see chapter 3.1).</p>
---	--

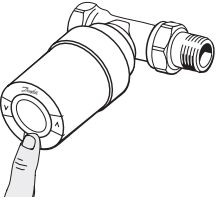
1.8 Installing living eco®

<p>1.</p>  <p>Screw <i>living eco</i>® onto the adapter and tighten by hand (max. 5 Nm).</p> <p>While slightly pressing forward, turn <i>living eco</i>® clockwise until it locks, then tighten.</p>	<p>2.</p>  <p>Activate Installation Mode to fix <i>living eco</i>® correctly onto the valve: Press  for 3 seconds to select the Function Menu. Select <i>M</i> with . When <i>M</i> flashes, press .</p>
<p>3.</p>  <p>A large <i>M</i> is flashing in the display to indicate that Installation Mode is activated.</p>	<p>4.</p>  <p>Press  to fix <i>living eco</i>®.</p>

1.9 Automatic adjustments

When *living eco*® is installed it will automatically begin to adjust itself to your heating system. During this process you might experience that the thermostat reacts slowly or turns the heat up and down by itself. This is normal and a necessary part of the adjustment process.

1. Adjusting to the valve

During the first night of operation *living eco*® will shut off the radiator heat and then open again to detect the exact opening point of the valve. This will allow *living eco*® to control the heat as efficiently as possible. If necessary, the procedure is repeated once a night for up to a week.







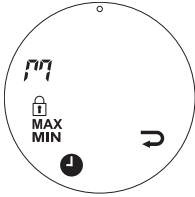

2. Intelligent Control (Forecast)

During the first week of operation *living eco*® learns when it is necessary to start heating the room in order to reach the correct temperature at the correct time.



The intelligent control will continuously adjust the heating time compared to seasonal temperature changes.

Using Saving Program requires that your heating system has enough heat for a short period during heat up. If your experience problems you should contact your installer.

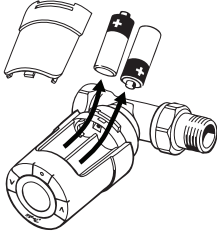
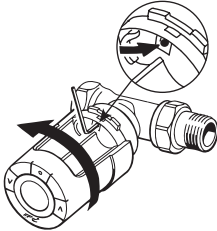
1.10 Removing *living eco*®

<p>1.</p>  <p>Activate Installation Mode: Press  for 3 seconds to select the Function Menu. Select  with . When  flashes, press .</p>	<p>2.</p>  <p>A large  is flashing in the display to indicate that Installation Mode is activated.</p>
<p>3.</p>  <p>Remove the battery cover and the batteries.</p>	<p>4.</p>  <p>Insert the Allen key or similar into the hole to lock the adapter ring. Turn counterclockwise to unscrew <i>living eco</i>® from the adapter.</p>

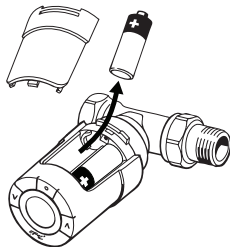
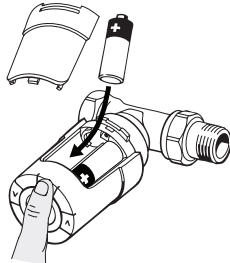

1.11 Resetting *living eco*® to default settings

<p>1.</p>  <p>Remove the battery cover and take out one battery.</p>	<p>2.</p>  <p>Press and hold  for approx. 5 seconds, while reinserting the battery.</p>
---	---

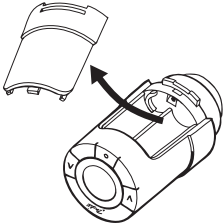
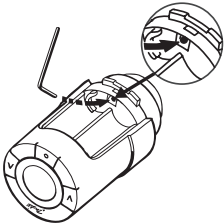
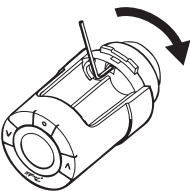
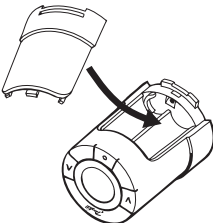
1.12 Removing an adapter from *living eco*®

<p>1.</p>  <p>Remove the battery cover.</p>	<p>2.</p>  <p>Insert a small hex key or similar into the locking hole to lock the adapter ring.</p>
<p>3.</p>  <p>With the hex key locking the adapter ring, turn the adapter in the shown direction.</p>	<p>4.</p>  <p>Put back the battery cover. Mount <i>living eco</i>® on another valve adapter according to the instructions supplied with the adapter.</p>



2. Technical specifications

Thermostat type	Programmable electronic radiator valve controller
Recommended use	Residential (pollution degree 2)
Actuator	Electromechanical
Display	Grey digital with backlight
Software classification	A
Control	PID
Power supply	2 x 1.5 V alkaline AA batteries
Power consumption	3 μ W in standby 1.2 W when active
Battery life	2 years
Low battery signal	Battery icon will flash in display. If battery level is critical, the whole display will flash.
Ambient temperature range	0 to 40 °C
Transportation temperature range	-20 to 65 °C
Maximum water temperature	90 °C
Temperature setting range	4 to 28 °C
Measurement interval	Measures temperature every minute
Clock accuracy	+/- 10 min/year
Spindle movement	Linear, up to 4.5 mm, max. 2 mm on valve (1 mm/s)
Noise level	<30 dBA
Safety classification	Type 1
Open-window function	Activated at temperature drop of approx. 0.5 °C over 3 minutes
Weight (incl. batteries)	177 g (with RA adapter)
IP class	20 (not to be used in hazardous installations or in places where it will be exposed to water)
Approvals, markings etc.	  

3. Display and menus



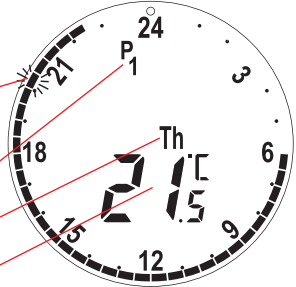



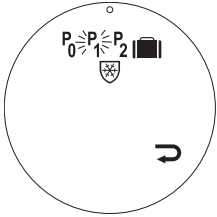

3.1 Home Screen

When pressing  the Home Screen appears with basic information on programming and operation of living eco®:

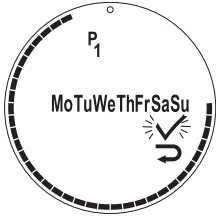

<p>Time is shown with the dashed circle, each segment representing 30 minutes.</p> <ul style="list-style-type: none"> • Black segments = periods with comfort temperature. • White segments = periods with setback temperature. • Flashing segment = current time. 	
<p>The chosen programme P0, P1, P2,  (Travel) or  (Frost Protection)</p>	
<p>Day of week</p>	
<p>The set temperature*</p>	

* living eco® is displaying the **set temperature**, not the **measured room temperature**.

3.2 Programme menu





<p>1.</p>  <p>To select the Programme menu: If the display is off, press , then press  again to open the programme menu. Use  to shift between the programmes, press  to confirm. The chosen programme is flashing,</p>	<p>2.</p>  <p>The comfort period is shown in the display. Use  to set the days. When  is flashing, press  to confirm.</p>
---	--

Display symbols in the Programme menu

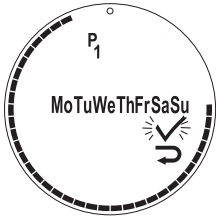

P₀	Programme without automatic temperature reduction. This programme maintains the temperature constant all day and night.
P₁	Saving programme which as default lowers the temperature to 17 °C at night (22:30 - 06:00 hrs). Time and temperature are configurable.
P₂	Extended saving programme which as default lowers the temperature to 17 °C at night (22:30 - 06:00 hrs), and during the day on weekdays (08:00 - 16:00 hrs). Time and temperature are configurable.
	Travel programme which lowers the temperature when you are away. Time and temperature are configurable.
	Frost protection program. The thermostat will maintain a constant temperature of 4-10 °C in the room, ensuring frost protection.

Note! Symbols must be flashing to be activated.

3.3 Function menu





<p>1.</p>  <p>To select the Function menu: If the display is off, press , then press  and hold for 3 seconds.</p>	<p>2.</p>  <p>Use   to shift between functions.</p>
--	--

Display symbols in the Function menu



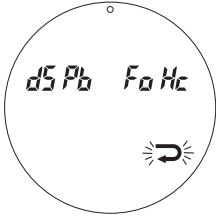

	Installation Mode must always be activated when installing or removing <i>living eco</i> ®. The thermostat may be irreparably damaged if not in the correct position during installation.
	Child Lock - see chapter 5.4.
MAX MIN	Set the max and min temperature range - see chapter 5.2.
	Set time and date - see chapter 5.1.

Note! Symbols must be flashing to be activated.

3.4 Advanced menu

<p>1.</p>  <p>To select the Advanced menu: If the display is off, press , then press  and hold for 3 seconds to open the Function menu.</p>	<p>2</p>  <p>Press both   buttons for 3 seconds to open the Advanced menu.</p>
---	--



Display symbols in the Advanced menu

	Back.
	Confirm selection.
	Low battery symbol.
	Period setting for the Travel programme.
dS	Deactivate/activate automatic daylight saving time - see chapter 5.3.
Pb	Adjust <i>living eco</i> ® to radiator/room conditions - see chapter 5.7.
Fo	Deactivate/activate intelligent control (Forecast) - see chapter 5.9.
Hc	Select moderate or quick heating control - see chapter 5.5

Note! Symbols must be flashing to be activated.

4. Temperature and programme settings

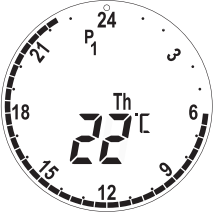
4.1 Setting the comfort temperature

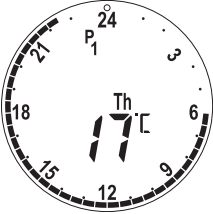
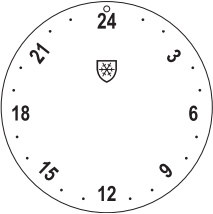
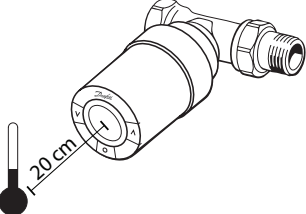
<p>1.</p>  <p>If the display is off, press . Use the  buttons to raise or lower the comfort temperature (default temperature 21 °C). <i>living eco</i>® will remember the new comfort temperature after the setback periods.</p>	<p>2.</p>  <p>If the temperature is changed during a setback period (default 17 °C), the new temperature will only be valid for this setback period. For a permanent change of the setback temperature, see chapter 4.3.</p>
<p>3.</p>  <p>If the comfort temperature is set at its lowest, the Frost Protection icon is displayed, indicating that <i>living eco</i>® will maintain a constant temperature of 4-10 °C in the room.</p>	<p>4.</p>  <p><i>living eco</i>® is measuring the temperature with two built-in sensors - one behind the display and one near the valve. Based on both readings the room temperature is calculated for an area approx. 20 cm in front of the display. This allows <i>living eco</i>® to control the actual room temperature very accurately. Be aware that sources of cold or heat, e.g. fireplace, direct sun or draft, might affect the function of <i>living eco</i>®.</p>

*Note! If the set temperature is raised more than 1 °C *living eco*® will boost the radiator heat to reach the new temperature faster. You can feel the valve and radiator are getting warmer. Minor temperature changes will not evoke a heat boost, and so the changes are made without any immediate indication.*

4.2 Default programme settings

Programme P₀

This programme is without automatic temperature reduction. It will maintain the temperature at a constant comfort level all day and night.

The default comfort temperature is 21 °C, but can be adjusted to any level between 6 and 28 °C.

0	3	6	9	12	15	18	21	24
21 °C								

Programme P₁

This is the default savings programme, which has a comfort temperature of 21 °C and one setback period from 22:30 to 6:00 hrs with a temperature of 17 °C. Time and temperature are configurable for both comfort and setback periods.

0	3	6	9	12	15	18	21	24
17 °C		21 °C					17 °C	

Programme P₂

This is the extended savings programme with a setback period from 22:30 to 6:00 hrs and an additional setback period from 8:00 to 16:00 hrs on weekdays. Time and temperature are configurable for both comfort and setback periods.

Weekdays:

0	3	6	9	12	15	18	21	24
17 °C		21 °C	17 °C			21 °C		17 °C

Weekend:

0	3	6	9	12	15	18	21	24
17 °C		21 °C					17 °C	

Travel Programme

This programme keeps the setback temperature (default 17 °C) all day and night. Use the programme to save energy, when you are away from home. Time and temperature are configurable.











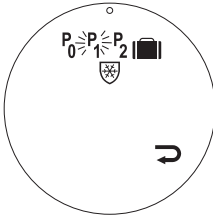



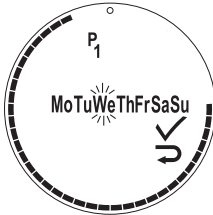





0	3	6	9	12	15	18	21	24
17 °C								

Frost Protection Programme

This programme keeps a low temperature (default 6 °C) all day and night. Use the programme to prevent damage of the radiator, when you are away from home. The temperature is configurable.











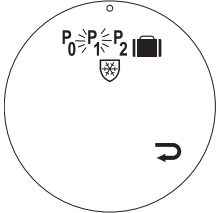



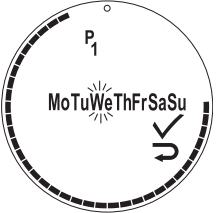

0	3	6	9	12	15	18	21	24
6 °C								

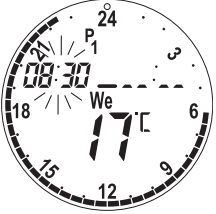
4.3 Adjusting a setback period











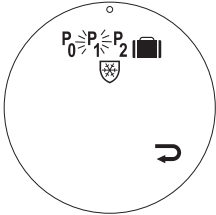

<p>1.</p>  <p>If the display is off, press , then press  again to open the programme menu. Use  to select the desired programme. When the chosen programme is flashing, press  to confirm.</p>	<p>2.</p>  <p>Use  to select the desired period - choose between the weekend, all weekdays or a single day. When the chosen day(s) flashes, press  to select.</p>
<p>3.</p>  <p>Start time for the setback period is flashing slowly. Use  to move between start and stop times, press  to select. The selection flashes faster to indicate it can be adjusted. Set the start and stop time using . Once the time is chosen, press  to confirm.</p>	<p>4.</p>  <p>The setback temperature now flashes. Use  to set the temperature, confirm using . ✓ flashes.</p>
<p>5.</p>  <p>If you wish to adjust another setback period, use  to go to  and press . Repeat the adjustments from picture 2.</p>	<p>6.</p>  <p>When ✓ flashes, press  to confirm the entire setback period.</p>

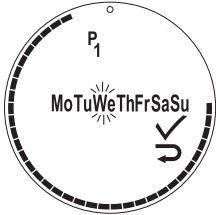
4.4 Creating a new setback period

living eco® allows you to create up to three setback periods for each day.



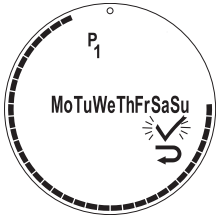







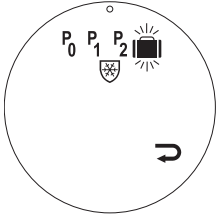













<p>1.</p>  <p>If the display is off, press , then press  again to open the programme menu. Use  to select the desired programme. When the chosen programme is flashing, press  to confirm.</p>	<p>2.</p>  <p>Use  to select the desired period - choose between the weekend, all weekdays or a single day. When the chosen day(s) flashes, press  to select.</p>
<p>3.</p>  <p>Start time for the existing setback period is flashing slowly. Use  to move to start time for the new setback period.</p>	<p>4.</p>  <p>When the start time for the new setback period flashes, use  to set the time and press  to confirm.</p>
<p>5.</p>  <p>Now the end time flashes. Use  to set the end time and press  to confirm.</p>	<p>6.</p>  <p>Now the setback temperature flashes. Use  to set the temperature and press  to confirm.</p>

4.5 Deleting a setback period

<p>1.</p>  <p>If the display is off, press , then press  again to open the programme menu. Use  to select the desired programme. When the chosen programme is flashing, press  to confirm.</p>	<p>2.</p>  <p>Use  to select the desired day(s), press  to confirm the selection.</p>
<p>3.</p>  <p>Start time for the setback period is flashing slowly. Press , the start time flashes faster. Use  to set start time to half an hour before stop time. Once you have changed the start time, press .</p>	<p>4.</p>  <p>✓ now flashes. Press  to confirm deletion of the setback period.</p>







4.6 Creating a Travel programme

A Travel programme keeps the setback temperature for a period, defined by you. Use a Travel programme to save energy, when you are away from home.



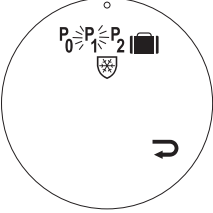







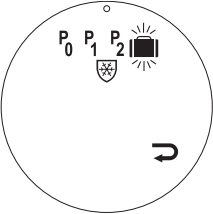



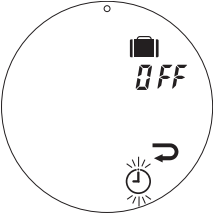

<p>1.</p>  <p>If the display is off, press , then press  again to open the programme menu. Use  to select . When the suitcase symbol flashes, press  to confirm.</p>	<p>2.</p>  <p>The current day is flashing. Use  to set the day of departure, press  to confirm. Now the current month is flashing. Use  to set the month of departure, press  to confirm.</p>
<p>3.</p>  <p>The day of return is flashing. Use  to set the day of return, press  to confirm. Now the month of return is flashing. Use  to set the month of return, press  to confirm.</p>	<p>4.</p>  <p>The setback temperature is flashing. Use  to set the setback temperature, press  to confirm.</p>
<p>5.</p>  <p>✓ flashes, press  to confirm your Travel programme.  is now displayed on the Home Screen.</p>	<p>6.</p>  <p>When the date of departure arrives, the display will show: , set Travel period and the setback temperature.</p>

4.7 Overrule a Travel programme (early return)







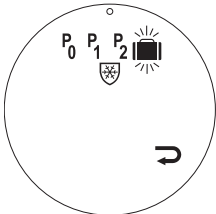

If returning earlier than expected you might wish to shift from the Travel programme to your normal programme.

<p>1.</p>  <p>If the display is off, press . The display will show: , set Travel period and the setback temperature.</p>	<p>2.</p>  <p>Press  again to open the programme menu. Use  to select the usual programme P0, P1 or P2, press  to confirm.</p>
---	--

4.8 Changing an existing Travel programme



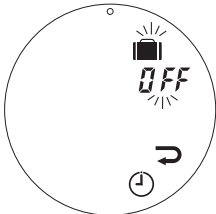







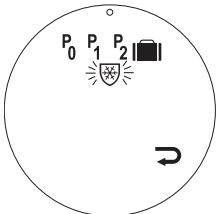

<p>1.</p>  <p>If the display is off, press , then press  again to open the programme menu. Use  to select , press  to confirm.</p>	<p>2.</p>  <p>Use  to select , press  to confirm.</p>
<p>3.</p>  <p>The day of departure is flashing, change with . Press  to confirm your changes and shift to the next value. When the necessary changes are made, press  to confirm.</p>	<p>4.</p>  <p>✓ now flashes. Press  to confirm your changes of the Travel programme.</p>

4.9 Deleting a Travel programme

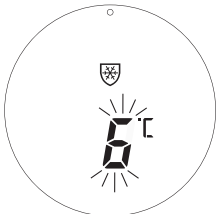
<p>1.</p>  <p>If the display is off, press , then press  again to open the programme menu. Use  to select , press  to confirm.</p>	<p>2.</p>  <p>Use  to select OFF, press  to confirm.</p>
--	--





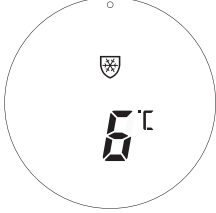





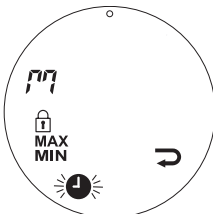









4.10 Creating a Frost Protection programme

The frost protection programme keeps the setback temperature until another programme is selected.







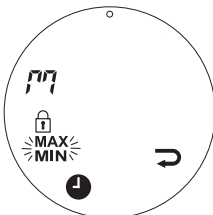

<p>1.</p>  <p>If the display is off, press , then press  again to open the programme menu. Use  to select . When the Frost Protection symbol flashes, press  to confirm.</p>	<p>2.</p>  <p>The Frost Protection temperature is flashing (6°C as default). Use  to set the Frost Protection temperature, press  to confirm.</p>
<p>3.</p>  <p>✓ flashes, press  to confirm your Frost Protection programme.  is now displayed on the Home Screen.</p>	<p>4.</p>  <p>To leave Frost Protection, just select another programme.</p>

5. Additional settings



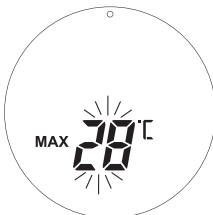







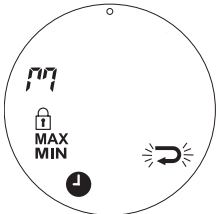



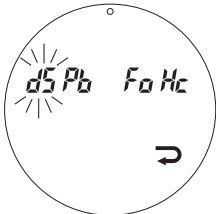

5.1 Setting the time

<p>1.</p>  <p>If the display is off, press , then press  again and hold for 3 seconds. Use  to select , press  to confirm.</p>	<p>2.</p>  <p>Hours flashes, use  to set and press  to confirm. Then Minutes flashes, use  to set and press  to confirm.</p>
<p>3.</p>  <p>Date flashes, use  to set and press  to confirm. Then Month flashes, use  to set and press  to confirm. Then Year flashes, use  to set and press  to confirm.</p>	<p>4.</p>  <p>✓ flashes. Press  to confirm your changes of time and date.</p>

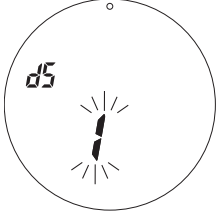
5.2 Limiting the temperature setting range



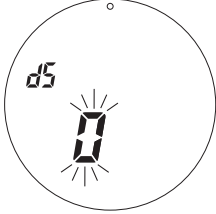





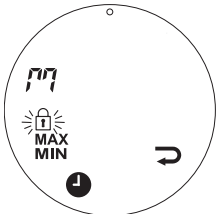

<p>1.</p>  <p>If the display is off, press , then press  again and hold for 3 seconds. Use  to select MAX/MIN, press  to confirm.</p>	<p>2.</p>  <p>Use  to set MAX temperature, press  to confirm. Use  to set MIN temperature, press  to confirm.</p>
--	--

5.3 Deactivating automatic daylight saving time



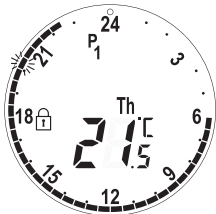











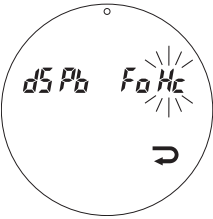

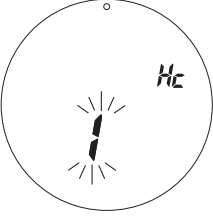

<p>1.</p>  <p>If the display is off, press , then press  again and hold for 3 seconds.  flashes.</p>	<p>2.</p>  <p>Press both   buttons for 3 seconds, use   to select <i>d5</i> and press  to confirm.</p>
<p>3.</p>  <p><i>1</i> flashes, indicating automatic daylight saving time is on. Use   to shift to <i>0</i>, press  to confirm.</p>	<p>4.</p>  <p><i>0</i> flashes, indicating automatic daylight saving time is off. Press  to confirm.</p>

5.4 Child Lock

Protect your *living eco*® settings from tampering by activating the Child Lock.

<p>1.</p>  <p>If the display is off, press , then press  again and hold for 3 seconds. Use   to select , press  to confirm.</p>	<p>2.</p>  <p> is shown on the Home Screen, indicating Child Lock is on. Deactivate Child Lock by pressing all three buttons    simultaneously for 5 seconds.</p>
--	--

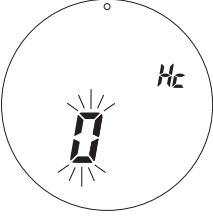
5.5 Setting the Heating Control

<p>1.</p>  <p>If the display is off, press , then press  again and hold for 3 seconds.  flashes.</p>	<p>2.</p>  <p>Press both   buttons for 3 seconds, use   to select Hc and press  to confirm.</p>
<p>3.</p>  <p> flashes, indicating moderate heating response is selected (recommended for district heating). Use   to shift to , press  to confirm.</p>	<p>4.</p>  <p> flashes, indicating quick heating response is selected (recommended for all boilers), press  to confirm.</p>

5.6 Open-window function





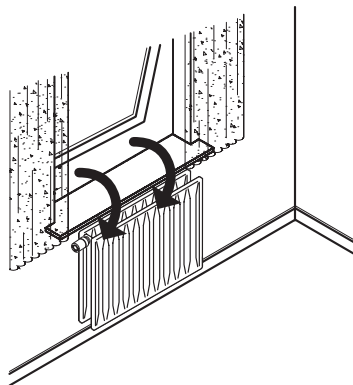





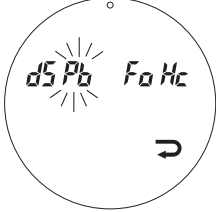

living eco® features an Open-window function, which closes the valve if the room temperature is falling dramatically, thus reducing the heat loss. The heat is turned off for up to 30 minutes, before *living eco*® returns to its original settings. When Open-window has been activated, the function is quarantined for 45 minutes.

Note! Be aware that the Open-window function will be affected, if curtains or furniture is covering living eco®, thus preventing it from detecting the decreasing temperature.

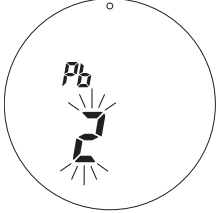

5.7 Adjusting to radiator/room conditions

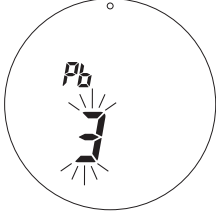
Change this setting if the radiator is over- or undersized for the room. This will help *living eco*® to work more efficiently.











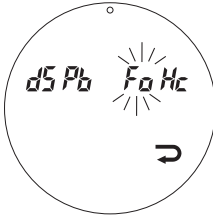

<p>1.</p>  <p>If the display is off, press , then press  again and hold for 3 seconds.  flashes.</p>	<p>2.</p>  <p>Press both   buttons for 3 seconds, use  to select <i>Pb</i> and press  to confirm.</p>
<p>3.</p>  <p>2 flashes, indicating the default setting. Use   to shift to 1 (oversized radiator) or 3 (undersized radiator)</p>	<p>4.</p>  <p>When 1 or 3 is selected, press  to confirm.</p>

5.8 Automatic valve exercising

To keep the radiator valve functional and at its best, *living eco*® automatically exercises the valve every Thursday at approx. 11:00 hrs by opening it fully and then return to normal setting.

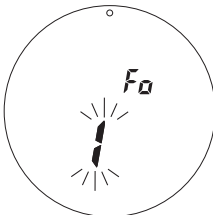
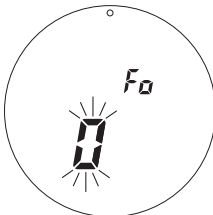
5.9 Deactivating intelligent Control (Forecast)

The Intelligent Control (Forecast) ensures that *living eco*® reaches the comfort temperature on time, according to the settings. This default function can be deactivated.

<p>1.</p>  <p>If the display is off, press , then press  again and hold for 3 seconds.  flashes.</p>	<p>2.</p>  <p>Press both  buttons for 3 seconds, use  to select <i>Fo</i> and press  to confirm.</p>
<p>3.</p>  <p>↑ flashes, indicating the Forecast is active (default setting).</p>	<p>4.</p>  <p>Use  to shift to , indicating the Forecast is deactivated. Press  to confirm.</p>

6. Safety precautions

The thermostat is not intended for children and must not be used as a toy.

Do not leave packaging materials where children may be tempted to play with them, as this is extremely dangerous.

Do not attempt to dismantle the thermostat as it contains no user-serviceable parts. If error code E1, E2 etc. is shown in the display or other defects appear, please return the thermostat to the distributor.

7. Disposal

The thermostat must be disposed of as electronic waste.



Installer

Danfoss A/S

Haarupvaenget 11

DK-8600 Silkeborg

Denmark

Phone: +45 7488 8000

Fax: +45 7488 8100

www.danfoss.com

www.living.danfoss.eu