

Honeywell | Home

Lyric™ T6 & T6R Smart Thermostat

EN User Guide



Lyric™ T6
Programmable Thermostat



Lyric™ T6R
Wireless Programmable Thermostat



connected by
Lyric App | Wi-Fi

Lyric T6 & T6R Smart Thermostat Features

- Connects to the Internet so you can control your heating system from anywhere with the Lyric App.
- Remotely view and change your heating system settings.
- Diverse programming options that fit any lifestyle:
 - Time Scheduling – program schedule supports daily or 5-2 with 6 time periods for each day
 - Geofencing – use a smartphone's location to manage comfort when home or away
 - Smart Scheduling – use a combination of geofencing and time scheduling to fit a busy lifestyle
- Group scheduling for multiple devices and locations (set-up and manage via the Lyric App).
- Receive alerts (such as boiler failure) from the Thermostat, App, and email.
- Get automatic upgrades.
- The free Honeywell Lyric App is available for Apple® iPhone® and iPad® devices at iTunes® or at Google Play® for all Android™ devices.



Lyric

Need help?

If you need more information, or for help with your Lyric Thermostat go to:

getconnected.honeywell.com

Contents





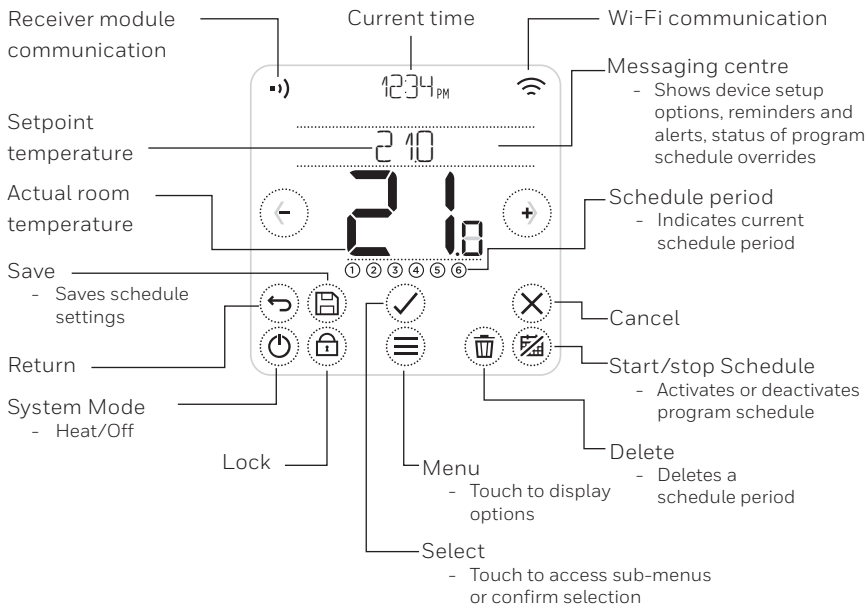









Quick reference to the display.....	4
Quick reference to the icons	5
Navigating the menu.....	5
Main menu.....	6
Connecting to a Wi-Fi® network	7
Disconnect or reconnect to a Wi-Fi network	7
Setting the system mode.....	8
Turn the schedule On/Off.....	8
Schedule options	8
Preset energy-saving schedules	9
Setting the vacation mode.....	9
Adjusting a program schedule	10
Overriding a program schedule.....	11
Optimisation functions	13
Locking the interface.....	13
Troubleshooting.....	14

Quick reference to the display









Note: To save power, the screen will dim and enter idle mode 45 seconds after the last button touch. The screen will light up when you touch any button.

Quick reference to the icons

- | | |
|----------------------------------------------------------------------------------------------------------|-----------------------------------------------------------------------------------------------------------------|
|  Geofencing active |  Heating demand active |
|  Geofencing home active |  Receiver module communication |
|  Geofencing away active |  Communication failure |
|  Geofencing sleep active |  Wi-Fi communication |
|  Failure/Alarm |  Wi-Fi failure |
|  Optimisation active | |
|  Schedule disabled | |
|  Schedule enabled | |
|  Temporary Hold active | |

Navigating the menu

-  (**MENU**): Touch to access all sub-menus, configurable options.
-  and  (**ARROWS**): Touch to navigate the sub-menus and options.
-  and  (**PLUS/MINUS**): Touch to change settings (temperature, date)
-  (**RETURN**): Touch to or go back to previous menu.
-  (**SELECT/CONFIRM**): Touch to confirm selection, or access a sub-menu.

Note: In addition to touching  (**SELECT**), a sub-menu can be accessed by touching the text in the message area (for example, **SCHEDULE**).

Main menu

The main menu lets you customise how the Thermostat displays information or responds to certain situations. The menus are:

SCHEDULE

View or edit the schedule

WI-FI

Setup or change Wi-Fi settings

CLEAN SCREEN

Disables screen for 30 seconds in order to clean it

LOCK

Restricts access to thermostat interface

LANGUAGE

Change the language

CLOCK

Set the time and date

IDLE BRIGHTNESS

Set the backlight brightness for the idle screen

SCHEDULE OPTIONS

Select the type of schedule to run

OPTIMISE

Configure optimisation settings (start/stop/delay)

TEMPERATURE OFFSET

Offsets the measured temperature

RESET

Reset the schedule, Wi-Fi or Homekit to factory default settings

DEVICE INFO

Device information like model, MAC code, etc.

Connecting to a Wi-Fi® network

Before continuing you should:

- Ensure your Wi-Fi is secure and set to 2.4GHz.
- Have a note of your home Wi-Fi network name and password.
- Switch on your smartphone or tablet Wi-Fi.

To connect your thermostat to your Wi-Fi network and register:

1 Download and install the Honeywell Lyric App from the Google Play or Apple App Store.



2 Open the Lyric App, press **"CREATE ACCOUNT"** and follow the App instructions.

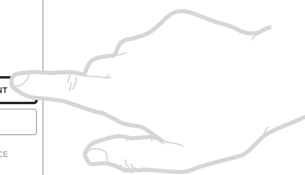
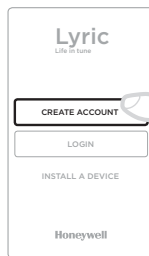

Once connected to your Wi-Fi network and Lyric App, the Thermostat will briefly display **SUCCESS** and the connected symbol  will be displayed in the upper right corner. The Thermostat will also set the time and date automatically once connected to the internet.

Disconnect or reconnect to a Wi-Fi network

If you need to disconnect the Thermostat from your Wi-Fi network (for example, you're replacing your router), or if you need to reconnect to another Wi-Fi network, follow the instructions described in the Lyric App under the menu 'Thermostat Configuration'.

Setting the system mode

Your Lyric Thermostat can switch heating equipment on or off, to effectively manage your comfort depending on the indoor condition and your preferred temperature.

- When the  button is touched, the Thermostat toggles the system Heating or Off.
- The available modes are:
 - **Heating On:** Controls the heating system to achieve desired temperature.
 - **Off**



Turn the schedule On/Off

Your Lyric Thermostat is a programmable thermostat with a schedule, but the schedule can also be turned off.

- Touch  to deactivate or activate the schedule.

Schedule options

Your Lyric Thermostat has three schedule types:

- **Daily** (7-day) : Individual program for each day of the week.
- **5 + 2 days** : Individual program for weekdays and weekend.
- **Geofence** : Location based temperature control.
Can only be enabled and configured using the Lyric App.

Preset energy-saving schedules

Your Lyric Thermostat comes with the following default schedule. To change these settings go to 'Adjusting program schedules' on the next page.

	Mon-Fri		Sat + Sun	
Period	Time	Temperature	Time	Temperature
1	6:30 - 8:00	19 °C	8:00 - 10:00	19 °C
2	8:00 - 18:00	16 °C	10:00 - 17:00	16 °C
5	18:00 - 22:30	21 °C	17:00 - 23:00	21 °C
6	22:30 - 6:30	16 °C	23:00 - 8:00	16 °C

For more scheduling options, go to your Lyric App.

Setting the holiday mode

This feature helps you save energy while you are away for longer periods, and restores comfortable settings just before you return home.

- To activate your holiday period, in your Lyric App go to Menu/Setting/Holiday
- **HOLIDAY** is indicated on the Thermostat.
- You can cancel Holiday Mode either on the Thermostat or in the Lyric App.
Touch  on your Thermostat home screen to resume the regular program schedule.

Adjusting a program schedule

1. Use  and  to go to **SCHEDULE**

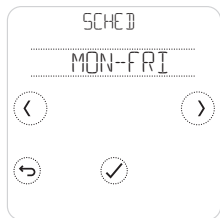

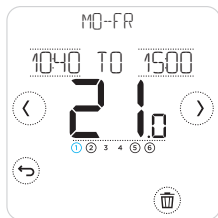

2. Select day(s) to be adjusted.



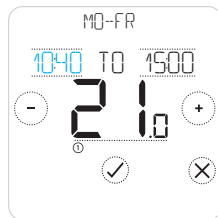

3. Select time period to be adjusted. The selected period flashes.

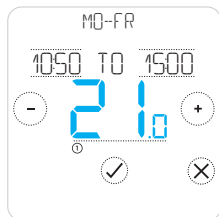

4. Touch time that needs to be changed. Touch  or  to change it. Repeat with other time.



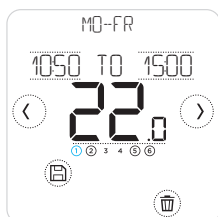

5. Touch the period's temperature to change it. It will start flashing. Touch  or  to adjust the temperature. Touch  to confirm the changes.



6. When you have finished adjusting the schedule, touch  to save the changes.

Delete a period

Touch  to delete the selected period. The screen will read **DELETE**.

Touch  to confirm or  to cancel without deleting.

Touch  to save the schedule changes.

Overriding a program schedule

You can override the program schedule in two different ways:

1. **Temporary override** “Hold Until”
2. **Permanent override** “Permanent Hold”

Hold Until

- The schedule will resume when the Hold Until time expires.
- Touch  to cancel the Hold Until and resume the regular schedule.



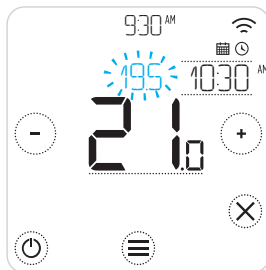

1. Touch  or  to adjust temperature.

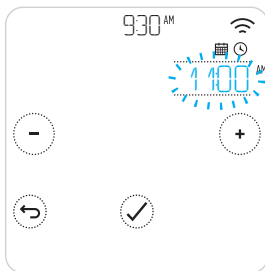

2. During temperature adjustment, the Until time appears.



3. Touch the time to changes it and use  or  to adjust.







4.  indicates Hold Until is active.

Overriding a program schedule (continued)

Permanent Hold







1. Touch  to deactivate the schedule and activate a permanent hold.
2. Touch  or  to adjust temperature.
3. Touch  to cancel the Permanent Hold and resume the regular schedule.

Geofencing

Your new Lyric Smart Thermostat supports location-based scheduling which can intelligently override the time-based schedule. If your schedule varies or you regularly depart and return at different times, the Lyric Thermostat can automatically adjust to your life. No rigid scheduling. No learning period. Just comfort when you're home and savings when you're away.

When you enable the Lyric geofence schedule, it intelligently controls your heating based on whether you are home or away.

- Active geofence schedule is indicated by  in the top left corner of the screen. Home/Away/Sleep status is indicated by ,  or .
- To learn more about configuring the geofence schedule, see 'Create New Schedule' menu in your Lyric App.
- To learn more about how smart geofencing can work for you and how it fits to your busy lifestyle, go to getconnected.honeywell.com

Optimisation functions

Your Thermostat has several optimisation functions. These functions aim to save energy while making you as comfortable as possible.

Configure these options via the **OPTIMISE** menu on your Thermostat.

- **Optimum Start**

Over time, the Thermostat learns how long it takes your system to reach the temperature you want. It turns on the heating or cooling system earlier to make sure you're comfortable at the time you expect. The Thermostat displays  when it turns the system on early.

- **Optimum Stop**

Saves energy and money by switching off a little bit earlier than the normal programmed time. If your home is up to temperature, you will not notice the effect on the temperature, but you will see a difference in your fuel bill.

- **Delayed Start**

Saves energy by slightly delaying the start of heating depending on the difference between the programmed temperature and the actual room temperature.

Locking the interface

Your Lyric Thermostat has a lock function, which can restrict access to the Thermostat interface in two levels:

- **PARTIAL:** Allows changing the setpoint temperature only
- **FULL:** Restricts all access to the Thermostat interface

When the function is activated a PIN is given to unlock the thermostat - take note of the PIN.

Troubleshooting

If you have difficulty with your Thermostat, try these suggestions. Most problems can be corrected quickly and easily.

Screen is blank	<ul style="list-style-type: none">• Make sure power is switched on.• Check circuit breaker and reset if necessary.
Heating system does not respond	<ul style="list-style-type: none">• Touch  to set system to Heat. Make sure the set temperature is higher than the actual temperature.• Check the circuit breaker and reset if necessary.• Check the heating system is powered on.• Check the Receiver Box is working.

List of alerts: 

Touch  to dismiss the alert.  To snooze the alert for 7 days

WIFI RADIO ERROR	The Wi-Fi radio of your Thermostat is faulty, contact your installer.
INTERNAL MEMORY ERROR	The internal memory of your Thermostat is faulty, contact your installer.
THERMOSTAT TEMPERATURE SENSOR ERROR	The temperature sensor of your Thermostat is faulty, contact your installer.
INDOOR TEMPERATURE SENSOR ERROR	(T6 only) The remote indoor temperature sensor is not connected or the wiring is faulty, contact your installer.
OUTDOOR TEMPERATURE SENSOR ERROR	(T6 only) The remote outdoor temperature sensor is not connected or the wiring is faulty, contact your installer.

Troubleshooting

List of alerts (continued): 

REGISTER ONLINE	Please download the App, create an account and register your Thermostat.
NO INTERNET	The internet connection has been lost, please check your internet connection or Wi-Fi router.
NO WIFI SIGNAL	The Wi-Fi signal has been lost, please check your Wi-Fi router.
WIFI NOT CONFIGURED	Please download the App, create an account and add your Thermostat. See also page 7.
NO RECEIVER BOX BINDING	There is no Receiver box binding data stored, contact your installer.
NO COMMUNICATION RECEIVER BOX	There is no communication with the Receiver box, move Thermostat closer or contact your installer.
RF SIGNAL OF RECEIVER BOX LOW	There is a weak radio signal from the Receiver box, move Thermostat closer or contact your installer.
BOILER FAILURE FAULT XX	The boiler reported a failure number XX, contact your installer.
BOILER LOW WATER PRESSURE	The boiler reported low water pressure, top up the system or contact your installer.



Lyric™ T6 & T6R Smart Thermostat

Need help?

Go to: **getconnected.honeywell.com**

Honeywell Control Systems Ltd.
Skimped Hill Lane, Bracknell, Berkshire
RG12 1EB

www.honeywelluk.com

© 2016 Honeywell International Inc.
Wi-Fi® is a registered trademark of Wi-Fi Alliance®
Printed in the EU

32317085-001 C

Use of the Works with Apple HomeKit logo means that an electronic accessory has been designed to connect specifically to iPod, iPhone, or iPad, respectively, and has been certified by the developer to meet Apple performance standards. Apple is not responsible for the operation of this device or its compliance with safety and regulatory standards.