

heatmiser®



Model: **PRT-B**



Table of Contents

Product Image	1	Holiday Programming	20
Table of Contents	2	Frost Protection	21
What is a Programmable Room Thermostat?	3-4	Power ON / OFF	21
Installation Procedure	5-6	Optional Features	23-26
Installing the Batteries	7-8	Re-calibrating the Thermostat	27
Replacing the Batteries	9	Factory Reset	28
Pairing with the RC1-W Receiver	10	Wiring Diagrams	29-30
LCD Display	11-12		
Setting the Clock	13		
Temperature Display	14		
Setting the Comfort levels	15-16		
Locking the Thermostat	17		
Setting the Temperature	18		
Temperature Hold	19		

? What is a Programmable Room Thermostat?

A programmable room thermostat is both a programmer and a room thermostat.

The programmer allows you to set “On” and “Off” periods to suit your own lifestyle. The room thermostat works by sensing the air temperature, switching on the heating when the air temperature falls below the thermostat setting, and switching it off once this set temperature has been reached.

So a programmable room thermostat lets you choose what times you want the heating to be on, and what temperature it should reach while it is on. It will allow you to select different temperatures in your home at different times of the day (and days of the week) to meet your particular needs and preferences.

Setting a room thermostat to a higher temperature will not make the room heat up any faster. How quickly the room heats up depends on the design of the heating system.

Similarly reducing the temperature setting does not affect how quickly the room cools down. Setting a programmable room thermostat to a lower temperature will result in the room being controlled at a lower temperature, and saves energy.

The way to set and use your programmable room thermostat is to find the lowest temperature settings that you are comfortable with at the different times you have chosen, and then leave it alone to do its job.

The best way to do this is to set the room thermostat to a low temperature – say 18°C, and then turn it up by 1°C each day until you are comfortable with the temperature. You won’t have to adjust the thermostat further. Any adjustment above this setting will waste energy and cost you more money.

If your heating system is a boiler with radiators, there will usually be only one programmable room thermostat to control the whole house. But you can have different temperatures in individual rooms by installing thermostatic radiator valves (TRVs) on individual radiators.

If you don’t have TRVs, you should choose a temperature that is reasonable for the whole house. If you do have TRVs, you can choose a slightly higher setting to make sure that even the coldest room is comfortable, then prevent any overheating in other rooms by adjusting the TRVs. The time on the programmer must be correct. Some types have to be adjusted in Spring and Autumn at the changes between Greenwich Mean Time and British Summer Time.

You may be able to temporarily adjust the heating program, for example, “Override”, “Advance” or “Boost”. These features are explained in the instructions if they apply to your specific model.

Programmable room thermostats need a free flow of air to sense the temperature, so they must not be covered by curtains or blocked by furniture. Nearby electric fires, televisions, wall or table lamps may also prevent the thermostat from working properly.



Installation Procedure



Do
Mount the thermostat at eye level.
Read the instructions fully so you get the best from our product.



Don't
Do not install near to a direct heat source as this will affect functionality.
Do not push hard on the LCD screen as this may cause irreparable damage.

This battery thermostat is designed to be surface mounted.

Step 1

Carefully separate the front half of the thermostat from the back plate by placing a small flat head terminal driver into the slots on the bottom face of the thermostat.

Step 2

Mark 2 hole positions on the wall using the back plate as a positioning template. Drill the marked positions and insert a wall plug into each hole. Terminate the thermostat as shown in the diagrams on pages 29-30 of this booklet.

Step 3

Screw the thermostat back plate securely on the wall and fit the terminal cover.

Step 4

Clip the front of the thermostat back onto the thermostat back plate.

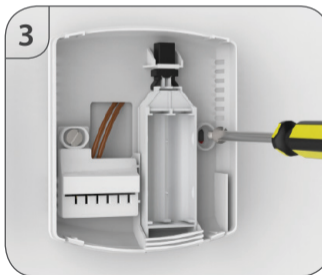



Installing the Batteries

2x AAA batteries have been supplied with this thermostat.

To access the battery holder, push and release the compartment door located on the bottom face of the thermostat.



Insert the batteries in the empty battery holder, ensuring that each battery is orientated for the correct polarity + / - .



Push the battery holder back inside the thermostat until it is secured in its closed position.



Replacing the Batteries

Batteries have a fixed lifespan and will need to be replaced occasionally to ensure the thermostat operates correctly.

The thermostat will inform you when the batteries need to be replaced by displaying the battery icon on screen.

Note: You must replace the batteries within 1 minute of removal in order to retain the current clock and comfort level settings.



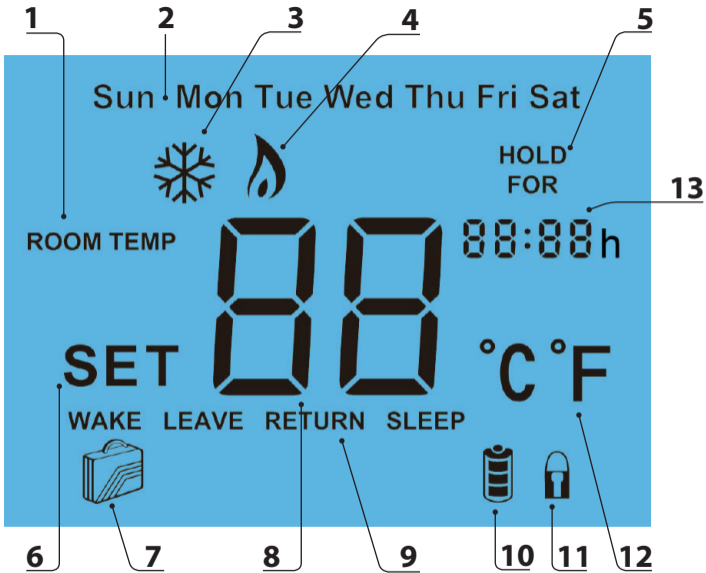







LCD LCD Display

1. Room Temp - Indicates the current temperature sensor mode.
2. Day Indicator - Displays the current day.
3. Frost Icon - Displayed when the thermostat is in frost protection mode.
4. Flame Icon - Displayed when the thermostat is calling for heat, the flame icon will flash when the optimum start function is in operation.
5. Temperature Hold - When a Temp Hold is active, HOLD FOR and the remaining time period is displayed.
6. Set - Indicates when changes are being made to programs or temperature set points.
7. Holiday Indicator - Displayed when the thermostat is in holiday mode.
8. Current Temp - Indicates the current sensor temperature.
9. Program Cycle Indicator - Displayed during programming only to show which period is being altered.
10. Battery Level - Indicates when the batteries require replacement.
11. Keypad Lock Indicator - Displayed when the keypad is locked.
12. Units of Temperature - Degrees Celsius or Fahrenheit.
13. Clock - Digital clock display in 24h format.



Setting the Clock

To set the clock, follow these steps.

- With the thermostat turned ON, press the Clock key twice 
- Use the Up/Down keys to set the hours 
- Press H to confirm settings 
- Use the Up/Down keys to set the minutes 
- Press H to confirm settings 
- Use the Up/Down keys to set the day of the week 
- Press A to confirm settings and return to main display 

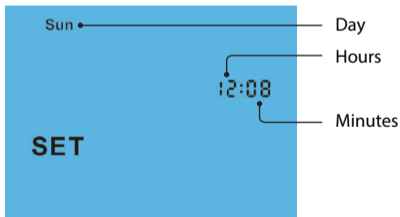

Temperature Display

The temperature display information is driven by two different inputs; the sensor measurement and the target temperature you have set.

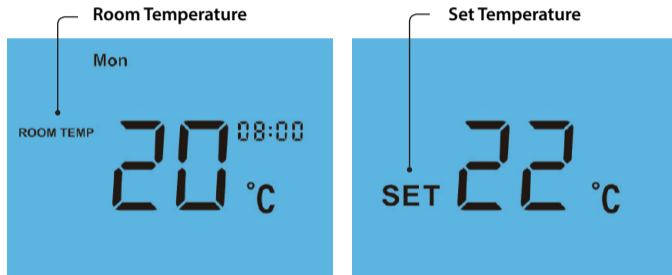

This is the current room temperature.

This is the temperature you are trying to achieve in your home.



Comfort Levels Explained

The thermostat provides Weekday/Weekend or 7 Day Programming options. You should consult the "Optional Features" section to select the required mode.

The thermostat is supplied with comfort levels already programmed, but these can be changed easily. The default times and temperatures are;

08.00 - 21°C (Wake) 09.30 - 16°C (Leave) 16.30 - 22°C (Return) 23.00 - 17°C (Sleep)

If you only want to use 2 levels, you should program the unused levels to --.--

Note: For Weekday/Weekend programming, the 4 comfort levels are the same for all weekdays but can be different for the weekends.

For 7 Day programming, each day can have 4 different comfort levels.







- To program comfort levels, press Clock once 



For Weekday/Weekend programming, Mon Tue Wed Thu Fri are displayed on screen.



For 7 Day programming, only Mon is displayed in the day indicator field.

- Use the Up/Down keys to enter the required WAKE time  
- Press H to confirm settings 
- Use the Up/Down keys to enter the required WAKE temperature  
- Press H to confirm settings 
- You will now see "LEAVE" displayed on screen.
- Repeat the programming steps for each period until complete.
- For unused periods enter --.-- and the thermostat will ignore the setting.
- Press A to confirm settings and return to main display 



Note:

- In 7 Day programming mode you can repeat for each day independently.
- In Weekday/Weekend programming mode you will see Sat Sun displayed on screen and can repeat for the weekend.
- To change the programming mode please refer to pages 25-26.*



Locking the Thermostat

The thermostat has a keypad lock facility. To activate the lock follow these steps.

- Press and hold the A and Down keys together for 10 seconds  
- You will see the lock symbol appear on screen 
- To unlock, repeat the steps above until the lock symbol disappears.

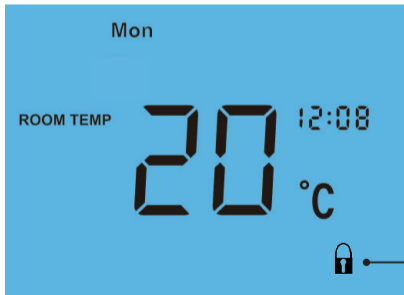

Note: The keypad lock indicator is only displayed when the lock is active.



Keypad Lock Indicator



Temperature Control

The Up/Down keys allow you to adjust the set temperature  

When you press either key, you will see the word SET and the desired temperature will be displayed on screen.

Use the Up/Down keys to adjust the SET value  

Press A to confirm settings and return to main display 

Note: This override will be maintained until the next programmed comfort level.

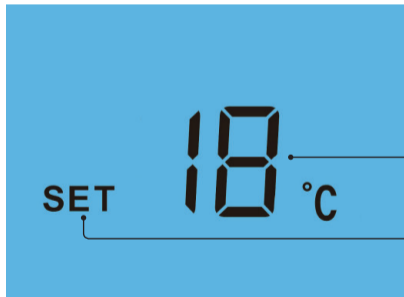

Set Temperature

Set Icon



Temperature Hold

The temperature hold function allows you to manually override the current operating program and set a different temperature for a desired period.

- Press H to commence temperature hold **H**
- Use the Up/Down keys to enter the required Hold time **▲ ▼**
- Press H to confirm settings **H**
- Use the Up/Down keys to enter the required Hold temperature **▲ ▼**
- Press A to confirm settings and return to main display **A**

You will see the Hold For indication is displayed on screen.

The time will countdown the set duration and then revert to the normal program.

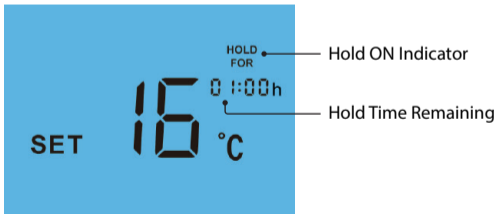

To cancel temperature hold, follow the same steps but reduce the Hold time to 00:00 hours.



Holiday

The holiday function allows you to quickly enter a holiday setting.

During a holiday, the thermostat will maintain the frost set temperature.

At the end of your holiday, the thermostat will revert back to the programmed setting ensuring that your home is warm on your arrival.

- Press H three times (until you see the suitcase on screen) **H**
- Use the Up/Down keys to enter the number of days holiday **▲ ▼**
- Press A to confirm settings and return to main display **A**

The display will show a suitcase indicating the thermostat is in holiday mode.

Note: A holiday period does not start until 00:00 the next day. For example, if you set a holiday period on Friday for 2 days, Saturday will be counted as the first day and the thermostat will revert back to the programmed schedule at 00:00 on Monday.

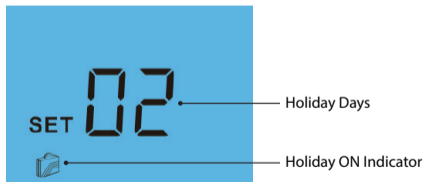

To cancel, follow the same steps but reduce the Holiday duration to 00 days.



Frost Mode

Pressing the  button once will place the thermostat in frost protect mode.

In this mode, the thermostat will display the frost icon and will only turn the heating on should the room temperature drop below the set frost temperature (see page 23).

Should the heating be turned on whilst in frost mode, the flame icon will be displayed.

To cancel the frost protect mode, press the  button once.



Frost Protection Mode Enabled



Heating On/Off

The heating is indicated ON when the flame icon is displayed.

When the flame icon is absent, there is no requirement for heating to achieve the set temperature but the thermostat remains active.

To turn the thermostat OFF completely, press and hold the Power button 
The display and heating output will be turned OFF completely.*

To turn the thermostat back ON, press the Power button once 

Thermostat completely OFF



Thermostat powered ON



*See Feature 3 on page 23



Optional Features Explained

THE FOLLOWING SETTINGS ARE OPTIONAL AND IN MOST CASES NEED NOT BE ADJUSTED

Feature 01 - Temperature Format: This function allows you to select between °C and °F.

Feature 02 – Switching Differential: This function allows you to increase the switching differential of the thermostat. The default is 1°C which means that with a set temperature of 20°C, the thermostat will switch the heating on at 19°C and off at 20°C. With a 2°C differential, the heating will switch on at 18°C and off at 20°C.

Feature 03 – Frost Protect: You can set whether the thermostat will maintain the frost temperature when the thermostat display is turned off. As a default, this is enabled.

Feature 04 – Frost Protect Temperature: This is the temperature maintained when the thermostat is in frost mode. The range is 07 - 17°C. The default is 12°C and is suitable for most applications.

Feature 05 – Output Delay: To prevent rapid switching, an output delay can be entered. This can be set from 00 - 15 minutes. The default is 00 which means there is no delay.

Feature 06 – Temperature Up/Down Limit: This function allows you to limit the use of the up and down keys. This limit is also applicable when the thermostat is locked and so allows you to give others limited control over the heating system.

Feature 07 – Optimum Start: Optimum start will delay the start up of the heating system to the latest possible moment to avoid unnecessary heating and ensure the building is warm at the programmed time. The thermostat uses the rate of change information to calculate how long the heating needs to raise the building temperature 1°C (with a rate of change of 20, the thermostat has calculated the heating needs 20 minutes to raise the building temperature 1°C) and starts the heating accordingly.



Feature 08 – Rate Of Change: Number of minutes to raise the temperature by 1°C, used with optimum start.

Feature 09 - Programming Mode: The thermostat offers 2 programming methods. Weekday/Weekend allows you to program 4 comfort levels for the weekdays and 4 different comfort levels for the weekend. In 7 Day program mode, each day as 4 comfort levels that can be programmed independently.





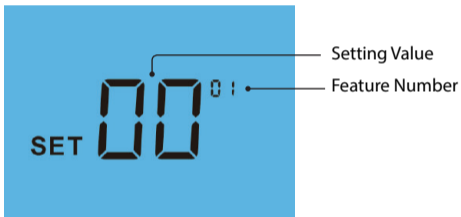

Adjusting the Optional Settings

To adjust the optional settings, follow these steps.

- Press and hold the Power button to turn the thermostat OFF 
- Press and hold the Clock key until the display appears as below 



- Use the Clock key to cycle through the features 
- Use the Up/Down keys to change the setting 
- Press A to confirm settings 
- Press the Power button once to turn the thermostat back ON 







Optional Settings - Feature Table

FEATURE	DESCRIPTION	SETTING
01	Temperature Format	00 = °C 01 = °F (°C = Default)
02	Switching Differential	01° - 03°C (Default 01°C)
03	Frost Mode	00 = Enabled 01 = Disabled (00 = Default)
04	Frost Protection Temperature	07° - 17°C (Default 12°C)
05	Output Delay	00 - 15 Minutes (00 = Default)
06	Up/Down Temperature Limit	00° - 10°C (00°C = Default)
07	Optimum Start	00 - 03 Hours (00 = Default)
08	Rate of Change	Minutes to raise by 1°C
09	Program Mode	00 = Weekday/Weekend 01 = 7 Day Programming (00 = Default)



Re-calibrating the Thermostat

If you need to re-calibrate the thermostat, follow these steps.

- Press and hold the Power button to turn the thermostat OFF 
- Press and hold BOTH the Power and Down keys together until the temperature appears on the screen 
- Use the Up/Down keys to configure the new temperature 
- Press A to confirm settings 
- Press the Power button once to turn the thermostat back ON 



Calibration Temperature Setting



Set Icon



Factory Reset

The thermostat has a reset function to restore all settings to their factory defaults.

To perform a factory reset, follow these steps.

- Press and hold the Power button to turn the thermostat OFF 
- Press and hold the Power and Up keys together until the LCD powers up. All of the icons will be displayed on screen 
- When the icons have disappeared from the screen, the thermostat has been successfully reset.
- Press the Power button once to turn the thermostat back ON 

All icons displayed simultaneously.

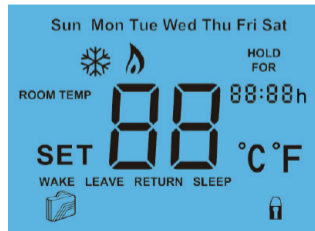

Factory reset is complete.





Wiring Diagram - PRT-B Switched Live & Valve Systems

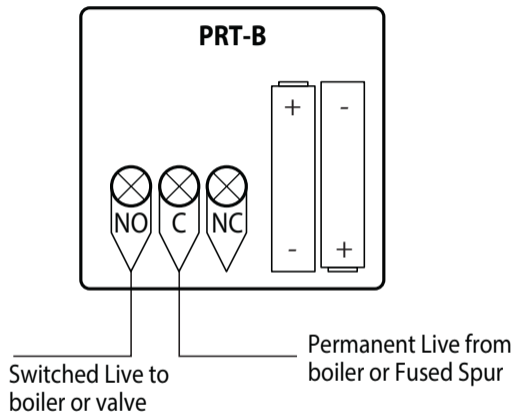

Note: When connecting to a valve, the valve auxiliary switch is used to enable the boiler.



Wiring Diagram - PRT-B Voltagefree & Combi Boiler Systems

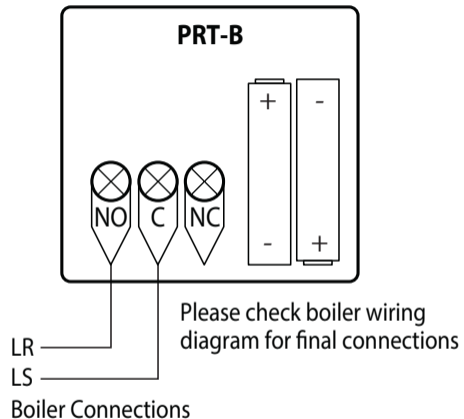

Note: LS & LR may be labelled differently but they are normally the boiler's room thermostat connections.



Heating Professionals:
Request a copy of our product installation guide containing detailed technical specifications for our complete product range:
www.heatmiser.com/guide

Want More Information?

Call our support team on: +44 (0)1254 669090

Or view technical specifications directly on our website:
www.heatmiser.com



PDF



FAQ



Twitter: [heatmiseruk](https://twitter.com/heatmiseruk)



Facebook: facebook.com/thermostats