

INSTALLATION INSTRUCTIONS

PRG7 7 DAY TWO CHANNEL DIGITAL PROGRAMMER

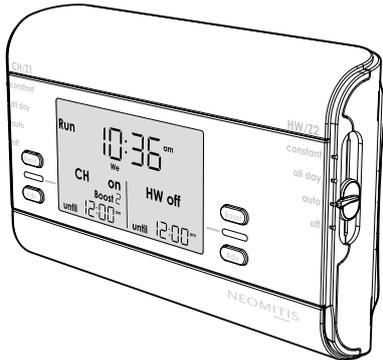

Pack contains	1
Installation	1
Mounting of wall mounting plate	1
Wiring	1
Mounting of the Programmer	2
Installer settings	3
Advanced installer setting	3
Technical specifications	4

PACK CONTAINS

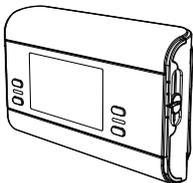

x1
Programmer

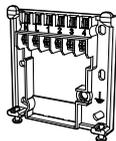

x1
Standard wall plate



x2
Screw Anchor

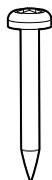

x2
Screws



INSTALLATION

MOUNTING OF WALL MOUNTING PLATE

The digital programmer is fixed on the wall with the wall plate which is supplied with the product.

- 1- Unscrew the 2 screws under the programmer.

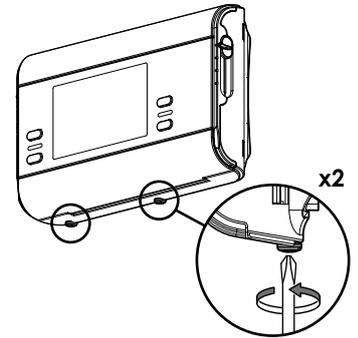

- 2- Remove the wall plate from the programmer.

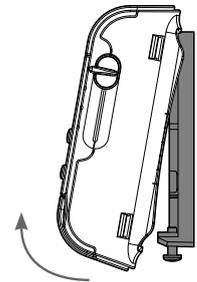

- 3- Secure the wall plate with the two screws provided using the horizontal and vertical holes.

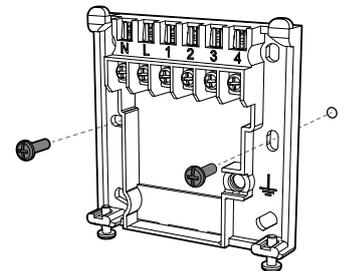

- 4- In case of surface mounting, a knock out area is provided on the wall plate and on the corresponding area of the programmer.

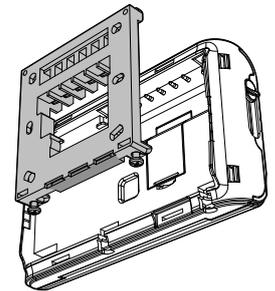

WIRING



All electrical installation work should be carried out by a suitably qualified Electrician or other competent person. If you are not sure how to install this programmer consult either with a qualified electrician or heating Engineer. Do not remove or refit the appliance onto the backplate without the mains supply to the system being isolated.

All wiring must be in accordance with IEE regulations. This product is for fixed wiring only.

• Internal wiring

- N = Neutral IN
- L = Live IN
- 1 = HW/Z2: Normal close output
- 2 = CH/Z1: Normal close output
- 3 = HW/Z2: Normal open output
- 4 = CH/Z1: Normal open output

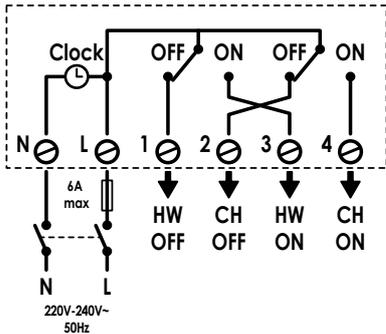
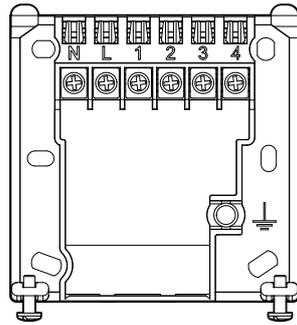

• Wiring diagrams

3 port system

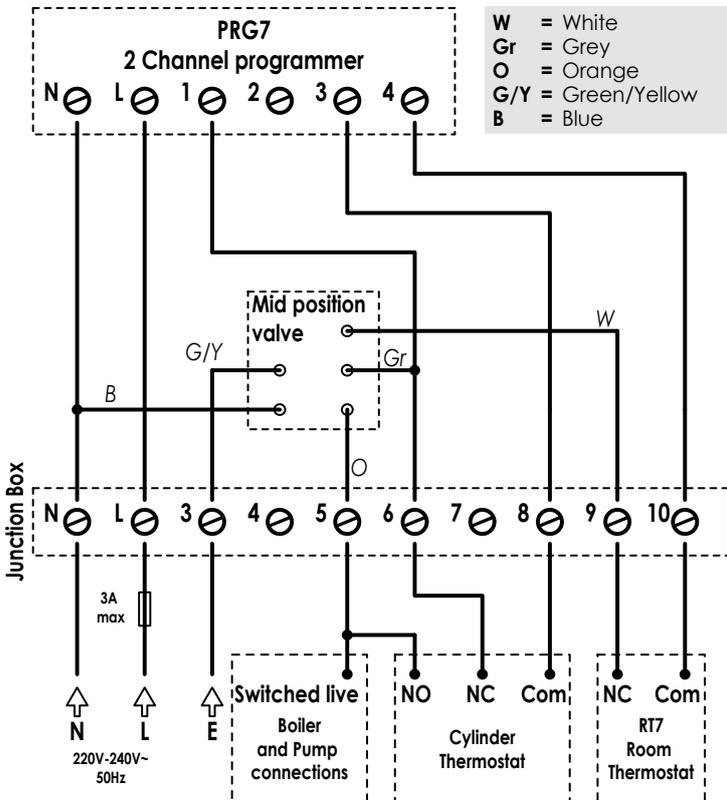

2 port system

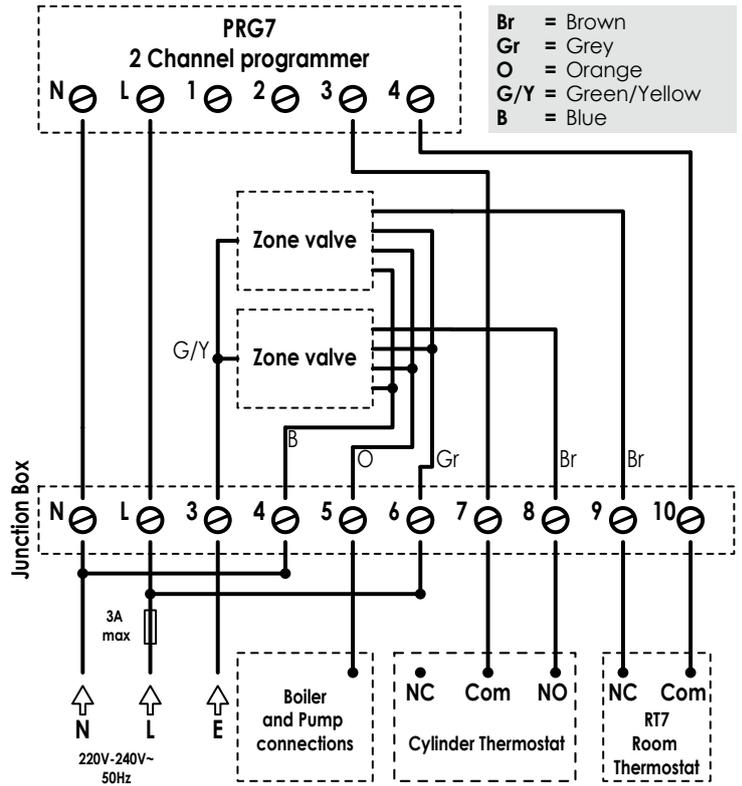

MOUNTING OF THE PROGRAMMER

- 1- Replace the programmer on the wall mounting plate.

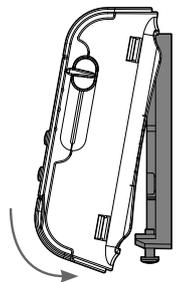

- 2- Secure the programmer by screwing both locking screws under the programmer.

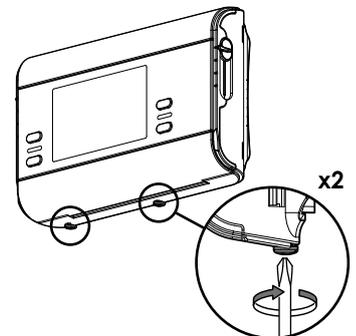



INSTALLER SETTINGS

ADVANCED INSTALLER SETTING

• Access

Move the 2 mode sliders to off position.

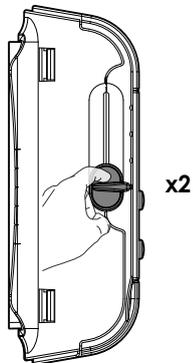

Move the programming slider to L position.

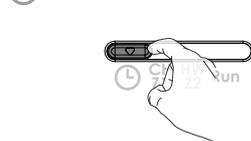

Press simultaneously **-** and **Review** for **5 seconds**.



5 advanced settings can be modified.

Press **Yes** until correct option is in display then use **-** or **+** to select your choice.

Setting number	Description
1	Select gravity/pumped mode
2	Set 12 or 24 hours clock
3	Activation of auto Summer/Winter change over
4	Set the number of ON/OFF periods
5	Select your system between Z1/Z2 or CH/HW

• Gravity/Pumped mode (1)

The pre-set system is **Pumped**.

1- Press **-** or **+** to change to Gravity (2).

- 1 = Pumped
- 2 = Gravity

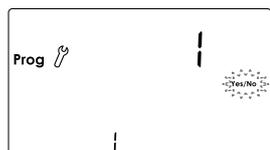

2- Then save by moving the programming slider or save and go to next setting by pressing **Yes**.



• Set 12/24 hours clock (2)

The pre-set value is **12** hours clock.

1- Press **-** or **+** to change to "24h".



2- Then save by moving the programming slider or save and go to next setting by pressing **Yes**.



• Auto Summer/Winter change over (3)

The auto Summer/Winter change over default is **ON**.

1- Press **-** or **+** to change to OFF

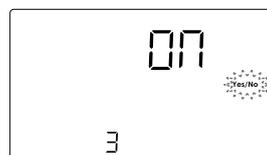

2- Then save by moving the programming slider or save and go to next setting by pressing **Yes**.



• Set number of ON/OFF periods (4)

You can adjust the number of ON/OFF switching time periods. The pre-set number is **2**.

1- Press **-** or **+** to change to 3 periods.

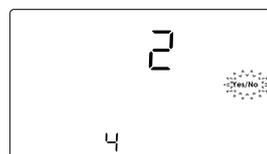

2- Then save by moving the programming slider or save and go to next setting by pressing **Yes**.



• Installation operating (5)

The digital programmer can manage Central Heating and Hot Water or 2 zones.

The pre-set choice is CH/HW.

1- Press **-** or **+** to change to Z1/Z2.

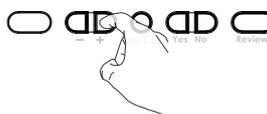
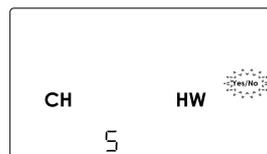

2- Then save by moving the programming slider or save and go to next setting by pressing **Yes**.



Note regarding the Advanced installer settings: If programming slider is moved, it will save changes and exit installer mode.



TECHNICAL SPECIFICATIONS

- Power supply: 220V-240V/50Hz.
- Output per relay: 3(2)A, 240V/50Hz.
- Rated impulse voltage: 4000V.
- Micro disconnection: Type 1B.
- Pollution degree: 2.
- Automatic action: 100,000 cycles.
- Class II.



Standards:

LVD	EMC	RoHS
EN60730-1		
EN60730-2-7	EN60730-1	
EN60730-2-9	EN60730-2-7	EN50581
EN60730-2-11	EN55014-2	
EN62311		

Environment:

- Operation temperature: 0°C to +40°C.
- Storage temperature: from -20°C to +60°C.
- Humidity: 80% at +25°C (without condensation)
- Protection rating: IP30.

Manufactured by: IMHOTEP création



The  on the product indicates that you must dispose of it at the end of its useful life at a special recycling point, in accordance with European Directive WEEE 2012/19/EU. If you are replacing it, you can also return it to the retailer from which you buy the replacement equipment. Thus, it is not ordinary household waste. Recycling products enables us to protect the environment and to use less natural resources.

Compliance declaration: we hereby declare under our sole responsibility that the products described in these instructions comply with all the main requirements of the LVD 2006/95/EC, EMC 2004/108/EC, RoHS 2011/65/EU and are manufactured using processes which are certified ISO 9001 V2008.



www.neomitis.com



NEOMITIS[®]

Creating innovative solutions for ambient comfort

NEOMITIS[®] LIMITED - 4th Floor, Lincoln House, 300 High Holborn, London WC1V 7JH
Registered in England and Wales No: 9543404

Tel: +44 (0) 2071 250 236 - Fax: +44 (0) 2071 250 267 - E-mail: contact_uk@neomitis.com

OPERATING INSTRUCTIONS

PRG7

7 DAY TWO CHANNEL DIGITAL PROGRAMMER

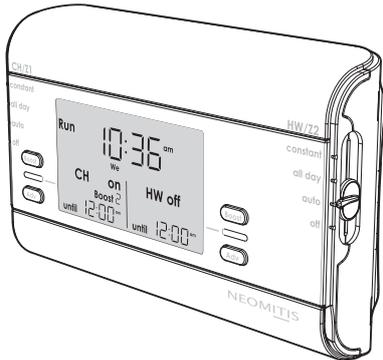

- Overview 1
- Controls and display 1
- Settings 1
 - Initial power up 1
- Programming 2
 - Set the CH/Z1 and HW/Z2 programming 2
- Operating 2
 - Mode selection and description 2
 - Boost 2
 - Advance 2
 - Holiday 3
 - Review 3
 - Factory settings 3
 - Set date and clock 3
- Troubleshooting 4
- Technical specifications 4
- What is a programmer? 4

OVERVIEW

Thank you for purchasing our PRG7, 7 day digital programmer. It is by listening to your requirements we have created and designed our products to be easy to operate and install. It is this ease of operation that is intended to make your life easier and help you save energy and money.



CONTROLS AND DISPLAY

Programmer

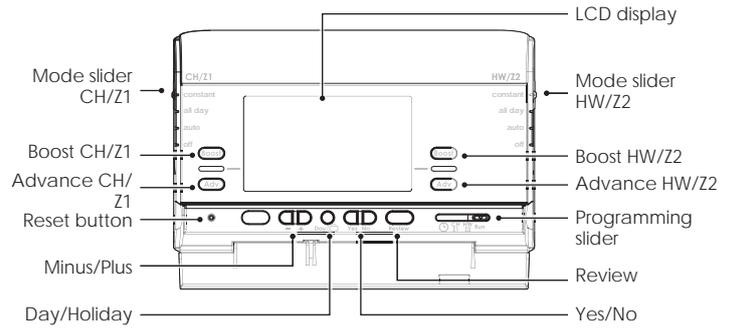

Programming sliders sequences:

Time → CH/Z1 programming → HW/Z2 programming → Run

LCD Display

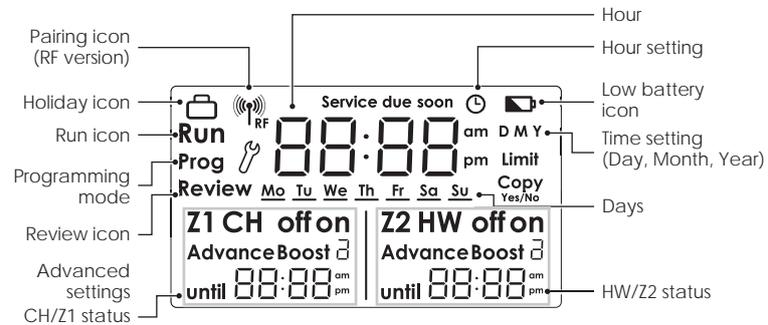

SETTINGS

INITIAL POWER UP

- 1- Switch on the programmer power supply.

All symbols will be displayed on the LCD screen as shown for two seconds.

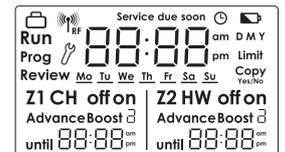

- 2- After 2 seconds, the LCD will show:

- The default time and day
- Run icon solid
- CH and HW systems are OFF

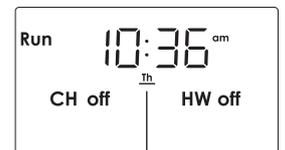

Note: When the battery must be changed, a low battery level indicator appears in the display.

Remember to take used battery to battery collection points so it can be recycled.



PROGRAMMING

Note : The unit is already set with correct date and time. Should programmer need resetting for any reasons, please see instructions on page 3.

SET THE CH/Z1 AND HW/Z2 PROGRAMMING

- 1- Move the Programming slider to position **CH**. All days of week are solid. Underscore and Yes/No are flashing.

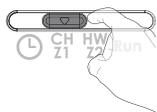

- 2- Press **Day** if you want to set another day of the week. Underscore moves under the other days. Then press **Yes** to program the underscored day.

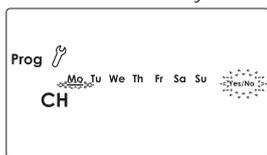

- 3- Press **+** or **-** to increment/decrement the first On/Off period **start** time. Then press **Yes** to confirm.

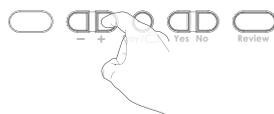
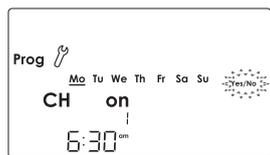

- 4- Press **+** or **-** to increment/decrement the first On/Off period **end** time. Then press **Yes** to confirm.

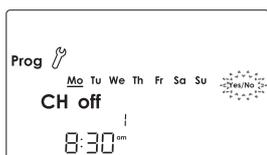

- 5- Repeat for the second On/Off period and for the third On/Off period. (Please refer to the advanced installer settings on Installation instruction to enable the third On/Off period).

On/Off periods	Default schedule	
Two On/Off periods settings		
Period 1	Start at 06:30 am	End at 08:30 am
Period 2	Start at 05:00 pm	End at 10:00 pm
Three On/Off periods settings		
Period 1	Start at 06:30 am	End at 08:30 am
Period 2	Start at 12:00 pm	End at 02:00 pm
Period 3	Start at 05:00 pm	End at 10:00 pm

- 6- The current program can be copy to the next days. Press **Yes** to copy or **No** to program manually the next day.

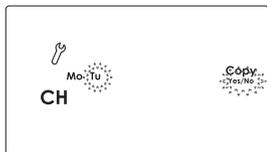

- 7- Slide the programming slider to position **HW** to confirm and program the second channel.

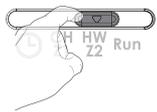

- 8- Repeat the previous step to program On/Off period for HW/Z2.

- 9- When finished, move the program slider to **Run** position to confirm.

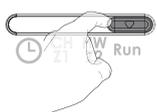

OPERATING

MODE SELECTION AND DESCRIPTION

Mode sliders sequences for CH/Z1 and HW/Z2:

Constant → all day → auto → off

Constant: Permanent ON mode. The system is permanently turned ON.



All day: The system turn ON from the first On period start time until the last Off period end time of the current day.

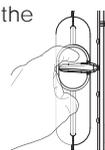

Auto: Automatic mode. The unit is controlling to the programming that have been selected (refer to "Programming" section page 2).



Off: Permanent Off mode. The system stays Off permanently. The boost mode can be still used.

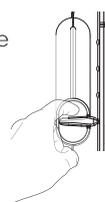

BOOST

BOOST: Boost mode is a temporary mode which allows you to switch ON for 2 or 3 hours. At the end of set period the device will revert to its prior setting.

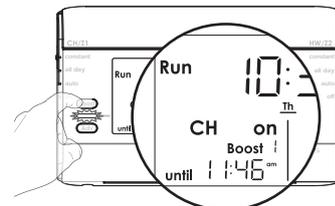

BOOST will work from any running mode.

BOOST is entered by pressing **Boost** button for corresponding system (CH/Z1 or HW/Z2).

Press **2 times** to set **2 hours** and **3 times** to set **3 hours**.

BOOST is cancelled by pressing again on Boost or movement of sliders. When BOOST is running the end of Boost period is shown for each system.

Note:

- The Programming slider must be in the **Run** position.
- There will be a slight delay between pressing **Boost** and activation of the relay.

ADVANCE

Advance: advance mode is a temporary mode which allows you to switch ON the system in advance, until the next On/Off period end time.

Press **Adv** button of corresponding channel to activate this mode. Press again **Adv** button to disable it before the end.

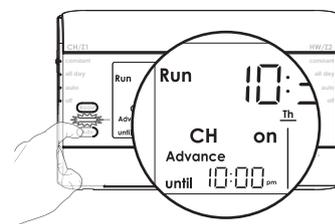

HOLIDAY

Holiday: Holiday mode allows to switch off the heating (or Z1) and hot water (or Z2) for a specified number of days, adjustable between 1 and 99 days.

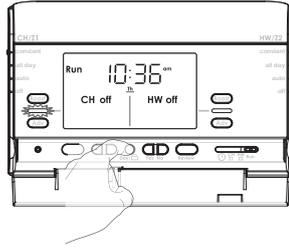

To set the holiday function:

1- Press Day button for 5 seconds.



5 sec.

3- Then press Yes to confirm. the heating (or Z1) and hot water (or Z2) switch Off and the number of remaining days will count down on display.



2- OFF appears on the display. Press + or - to increment or decrement the number of days.



4- To cancel the holiday function, press Day button.



REVIEW

Review: Review mode allows to review all programming in one time. The review starts from the beginning of the week and each steps appears each 2 seconds.

Press Review button to start the programming review. Press again to go back on normal operating mode.

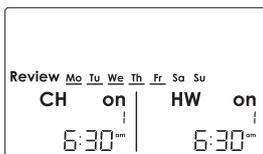

FACTORY SETTINGS

Settings	Factory settings	
Two On/Off periods settings		
Period 1	Start at 06:30 am	End at 08:30 am
Period 2	Start at 05:00 pm	End at 10:00 pm
Three On/Off periods settings		
Period 1	Start at 06:30 am	End at 08:30 am
Period 2	Start at 12:00 pm	End at 02:00 pm
Period 3	Start at 05:00 pm	End at 10:00 pm

Note: To restore factory settings, press and hold down this part for more than 3 seconds using the tip of a pen.



3 sec.

All LCD display will be turned ON for 2 seconds and the factory settings will be restored.

SET DATE AND CLOCK

1- Move the Programming slider to position . Preset year is solid.

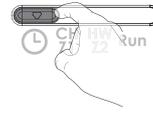

2- To select the current day, press +, to increment the year. Press -, to decrement the year.



Press Yes to confirm and set the current month.



3- The preset month appears. Press + to increment the month. Press - to decrement the month.



Press Yes to confirm and set the current day.



4- The preset day appears. Press + to increment the day. Press - to decrement the day.



Press Yes to confirm and set the clock.



01 = January ; 02 = February ; 03 = March ; 04 = April ; 05 = May ;
06 = June ; 07 = July ; 08 = August ; 09 = September ; 10 = October ;
11 = November ; 12 = December

5- The preset time appears. Press + to increment the time. Press - to decrement the time.



Move the program slider to any other position to confirm/finish this setting.

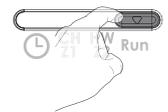

? TROUBLESHOOTING

Display disappears on programmer:

- Check fused spur supply.

Heating does not come on:

- If the CH Indicator light is on then it is unlikely to be a fault with the programmer.
- If CH indicator light is NOT ON then check programme then try BOOST as this should operate in any position.
- Check that your room thermostat is calling for heat.
- Check that the boiler is on.
- Check that your pump is working.
- Check that your motorised valve if fitted has opened.

Hot water does not come on:

- If the HW Indicator light is on then it is unlikely to be a fault with the programmer.
- If HW indicator light is NOT ON then check programme then try BOOST as this should operate in any position.
- Check that your Cylinder thermostat is calling for heat.
- Check that the boiler is on.
- Check that your pump is working.
- Check that your motorised valve if fitted has opened.

If the problem persists contact your installer

Note: If Service due soon or service due appears in display please contact your landlord.

TECHNICAL SPECIFICATIONS

Please refer to the installing instructions for any informations about standards and product environment.

? WHAT IS A PROGRAMMER?



...an Explanation for Householders. Programmers allow you to set 'On' and 'Off' time periods. Some models switch the central heating and domestic hot water on and off at the same time, while others allow the domestic hot water and heating to come on and go off at different times. Set the 'On' and 'Off' time periods to suit your own lifestyle. On some programmers

you must also set whether you want the heating and hot water to run continuously, run under the chosen 'On' and 'Off' heating periods, or be permanently off. The time on the programmer must be correct. Some types have to be adjusted in spring and autumn at the changes between Greenwich Mean Time and British Summer Time. You may be able to temporarily adjust the heating programme, for example, 'Advance', or 'Boost'. These are explained in the manufacturer's instructions. The heating will not work if the room thermostat has switched the heating off. And, if you have a hot-water cylinder, the water heating will not work if the cylinder thermostat detects that the hot water has reached the correct temperature.



www.neomitis.com



NEOMITIS

Creating innovative solutions for ambient comfort

NEOMITIS® LIMITED - 4th Floor, Lincoln House, 300 High Holborn, London WC1V 7JH

Registered in England and Wales No: 9543404

NEOMITIS® is a registered trademark of CO INTECH - SIRET 42243514900048 RCS ANGERS

Tel: +44 (0) 2071 250 236 - Fax: +44 (0) 2071 250 267 - E-mail: contact_uk@neomitis.com