

IRBS4-CP

COMMERCIAL Tap Range Infrared Temperature Control Automatic Basin Spout Chrome



Specification	
Style:	Contemporary
Product Type:	Commercial
Finish/Colour:	Chrome
Main Construction Material:	Brass
Mount Type:	Deck Mounted
Handle Type:	Infra-Red
Connection Inlet:	G1/2"
Number of Tap Holes Required:	1
Valve/Cartridge Type:	Solenoid Valve
Plumbing System Suitability	High Pressure Systems Only
Working Pressure Range:	Min 1.0 Bar, Max 5.0 Bar
Maximum Hot Water Temperature: °c	65
Power Rating:	AC: 220V-240V, 50/60HZ DC: 6V (4x AA Alkaline Batteries (Not supplied))
Maximum Static Pressure: (bar)	10
Flow Type:	Single Flow
Flow Rate: (l/min @ 3 bar)	5.4
Connection Outlet:	
Isolation Included:	No

Features:

- Non-touch control, using infrared sensing technology
- Temperature control for user comfort
- Maximum temperature stop for user safety
- Automatic switch off supports water saving
- BREEAM compliant

Product Certifications:

WRAS Certificate No: 1706044
WRAS Expiry Date: 30/06/2022



For more products, visit our website:



Dimensions (measurements in mm)

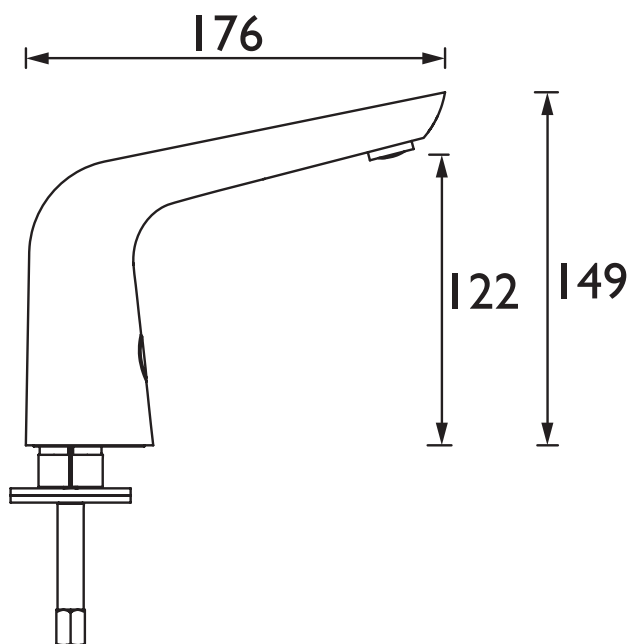

Flow Rates (l/min)

System Pressure (bar)	1	2	3	4	5
IRBS4-CP	3.7	4.8	5.4	5.4	5.4

TECHNICAL
DATA
SHEET



BRISTAN
TAPS & SHOWERS

D2