

INSTALLATION

Electrical Connection

Terminal	Function
COM	Common Contact (volt free input)
NO	Normally Open Contact (volt free output)
	Earth Parking
L	Incoming Mains - Live
N	Incoming Mains - Neutral

The RX10RF Receiver should be mounted in a suitable location that is both accessible for the connection of mains and control wiring, and allows good reception of the RF signal. The Receiver needs a 230V AC mains supply to operate, and this should be fused appropriately (16A max.).

The Receiver should be mounted in a location where it will not come into contact with water, moisture or condensation. There are few electrical connections required to the RX10RF, and these connections should be made to the terminal block inside the Receiver. No Earth connection is required for the correct and safe operation of the RX10RF, but a parking terminal is provided to connect an Earth wire if one is present.

- Loosen the screws at the bottom of the receiver unit.
- Unclip the front of the unit.
- Fit the back of the receiver unit to the wall using the fittings supplied.
- Wire up the receiver using one of the schematics*.
- Clip the front of the unit back on by aligning the fittings and pushing into place.
- Securely screw the front of the receiver in place.

Schematics

*Configured as RX1

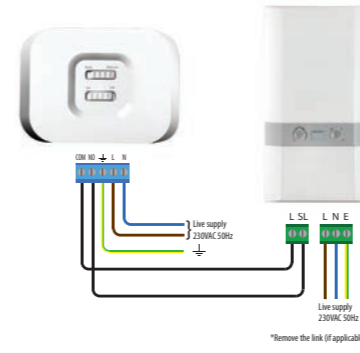

*Configured as RX2

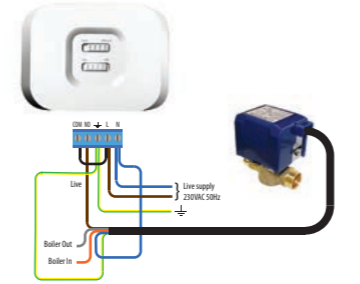

Reset Button

If for any reason the system receiver stops operating, press reset and check system operation.

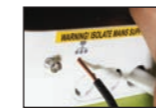

Replacing the System Receiver

If for any reason the system receiver needs to be removed/replaced, press the delete from network.

Power Up

- Ensure Coordinator is powered up and ready for pairing.
- Power up the receiver. The red light will flash.
- When the receiver has successfully joined the Zigbee network, the red LED will go steady.
- Please refer to VS10/VS20RF manual for system pairing.
- Once your system setup is complete, remember to take the coordinator out of pairing mode.

TECHNICAL DETAIL

Model	RX10RF
Type	Wired system receiver designed for 230VAC heating applications
Control	ON-OFF control
Environment Ratings	
Operating Temperature	0 °C to +50 °C
Storage Temperature	-20 °C to +60 °C
Operating Humidity	5-95 %RH
Switch Voltage	0-230VAC 16AMP
Power Source	230Vac 50Hz
User Interface	Slide switch, Bi Colour LED, RED/GREEN
Operating Temperature	0 to 50 °C
Storage Temperature	-20°C to 60°C
Frequency	2.4 GHz
Approval	CE

WARRANTY

SALUS Controls warrants that this product will be free from any defect in materials or workmanship, and shall perform in accordance with its specification, for a period of five years from the date of installation. SALUS Controls sole liability for breach of this warranty will be (at its option) to repair or replace the defective product.

Customer Name:
Customer Address:
..... Post Code:
Tel No: Email:
Engineers Company:
Tel No: Email:
Installation Date:
Engineers Name:
Engineers Signature:

SALUS Controls plc

SALUS House
Dodworth Business Park South,
Whinby Road,
Dodworth, Barnsley S75 3SP, UK.

SALES: T: +44 (0) 1226 323961
E: sales@salus-tech.com

TECHNICAL: T: +44 (0) 1226 323961
E: tech@salus-tech.com

www.salus-controls.com



SALUS Controls is a member of the Computime Group

Maintaining a policy of continuous product development SALUS Controls plc reserve the right to change specification, design and materials of products listed in this brochure without prior notice.

For PDF Installation guide please go to
www.salus-controls.com

SALUS
CONTROLS
Wireless Receiver Unit
Models: RX10RF



INSTALLER / USER MANUAL



For PDF Installation guide please go to www.salus-controls.com

INTRODUCTION

Thank you for purchasing the SALUS RX10RF system receiver. This unit is designed to work with iT600 range of Zigbee network products.

The RX10RF can be configured as remote boiler switch or a simple single channel output to control, a thermal actuator or zone valve. Please note the two configurations above can be used together in the one system.

These instructions are applicable to the SALUS model stated on the front cover of this manual only.

Product Compliance

This product is CE compliant and meets the following EC Directives Electro-Magnetic Compatibility directive 2004/108/EC Low voltage Directive 2006/95/EC.

Warning

This product must be fitted by a competent person, and installation must comply with the guidance, standards and regulations applicable to the city, country or state where the product is installed. Failure to comply with the requirements of the relevant guidance, standards and regulations could lead to injury, death or prosecution.

Sources of danger

The RX10RF must be disconnected from mains supply before removing the cover.

Emergency

Switch off the voltage to the individual thermostat wiring centre or complete system.

230V AC

Warning

Always isolate the AC Mains supply before installing or working on any components that require 230 VAC 50Hz supply.

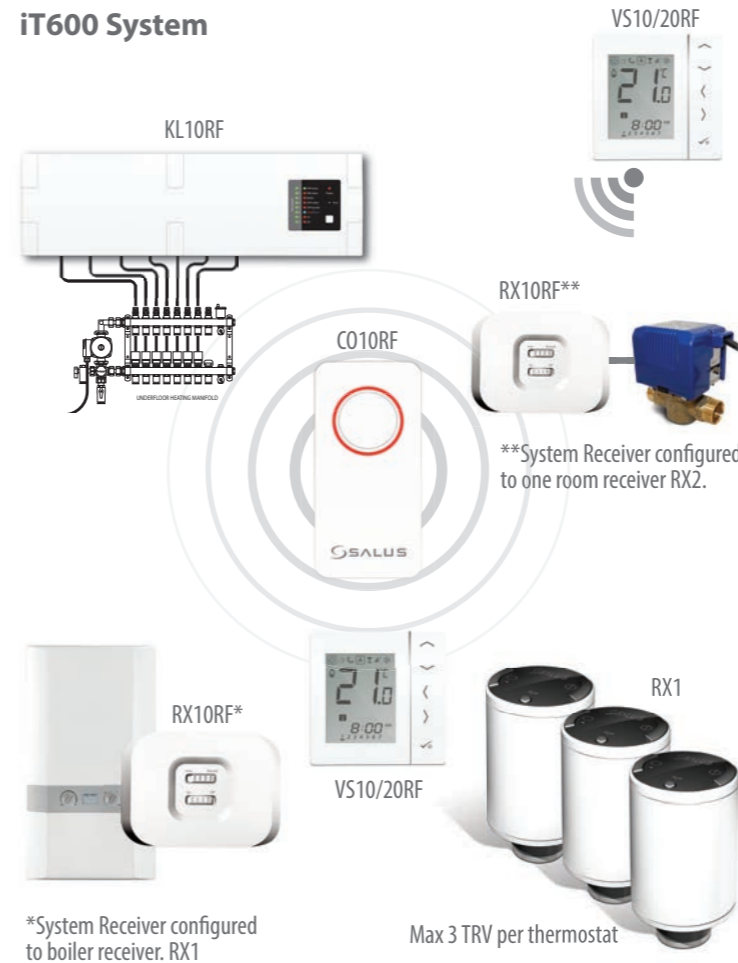

User Interface

- 1** AUTO – System receiver output will switch on and off in relation to the command from the iT600 transmitter. The bottom slide switch in active
- 2** RED led only in AUTO means that there is no output from the receiver.
- 3** RED and Green LED only in AUTO means that there is an output from the receiver. The device that the receiver is connected to will be switched on.
- 4** Manual- system receiver output is controlled by the bottom slide switch. Either permanently ON or OFF. The LED status in manual is the same as AUTO.

RX1 & RX2 RECEIVER CONFIGURATION

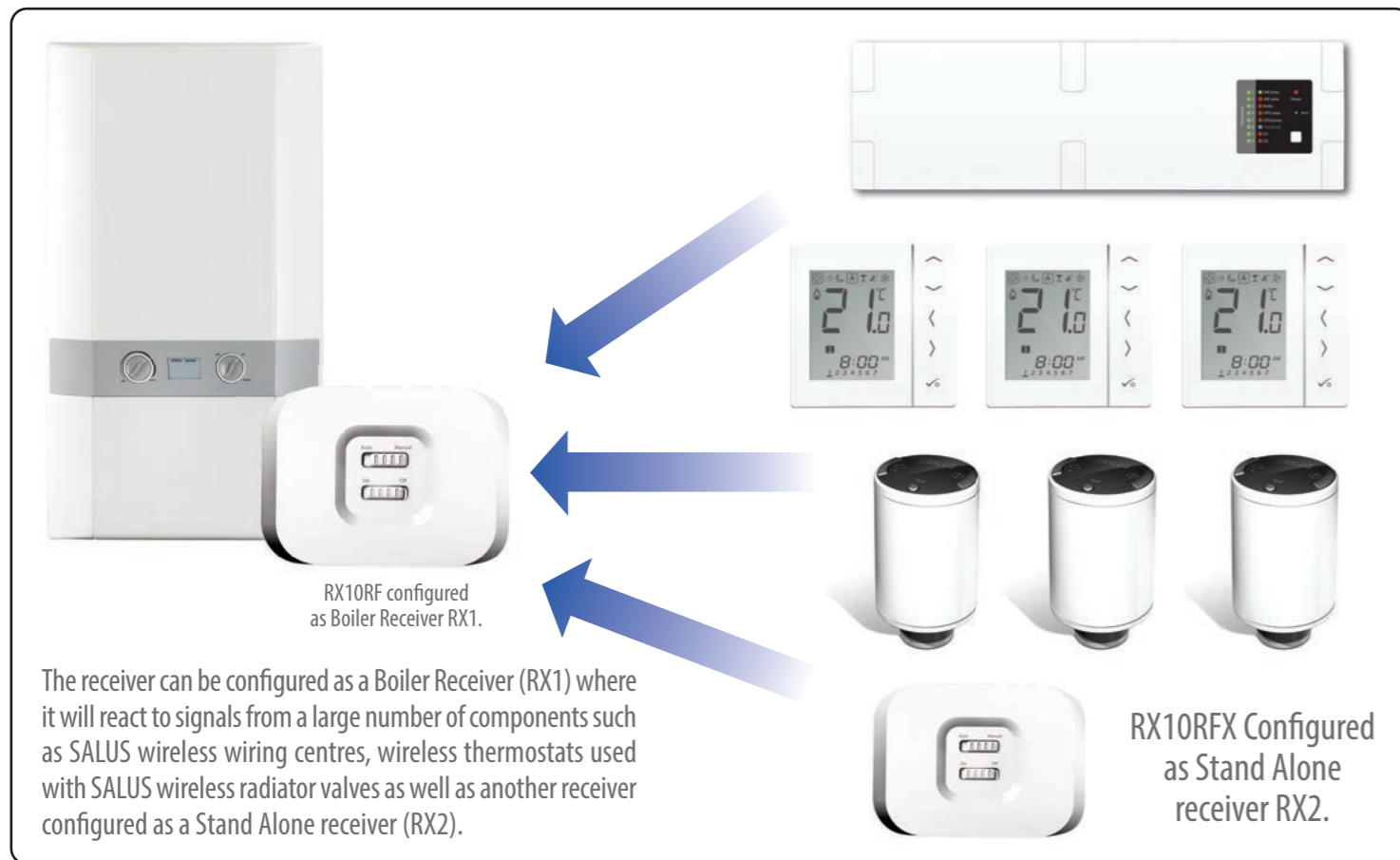

SYSTEM OVERVIEW - IT600 SYSTEM CONFIGURED AS RX1

The unit can be internally switched to be used on two channels, RX1 (boiler receiver) or RX2 (single room receiver). Ensure the unit is not powered during setting of the RX1/RX2 slide switch.

The unit is supplied with the switch in the RX1 position (Boiler Receiver). In this mode, the unit can be wired to the boiler to switch it on or off using the wireless signals it receives other SALUS products on the SALUS Zigbee network

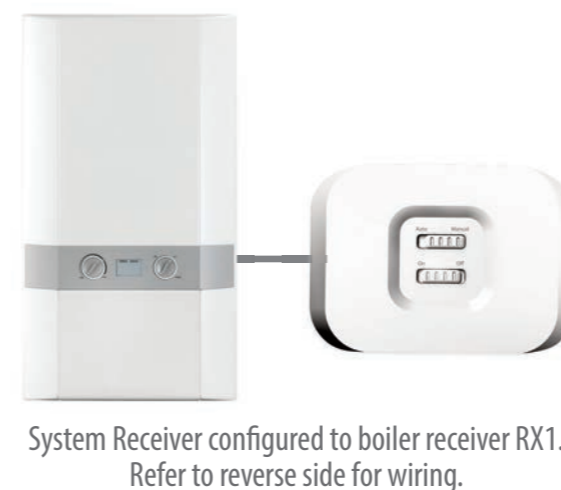
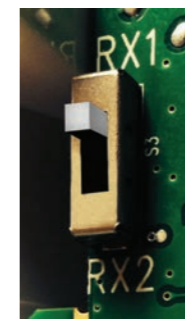

SYSTEM OVERVIEW - IT600 SYSTEM CONFIGURED AS RX2

With the unit switched to RX2, the unit will act as a single room receiver. Switching of the unit will be controlled by a paired SALUS VS10/20RF Thermostat. Depending on its intended use, the unit can be used to switch a motorised valve, thermal actuator or pump.

As well as being used in this way, the RX2 can be used in conjunction with another unit set up as an RX1 (Boiler receiver). When there is a call for heat from the thermostat paired to the RX2 both of the wireless receivers will operate turning on both the boiler and the motorised valve / pump.

NB: Only 1 RX1 and 1 RX2 can be used as part of a network.

