

BRISTAN

Installation Instructions and User Guide

WavePlus Dual Outlet Touchpad

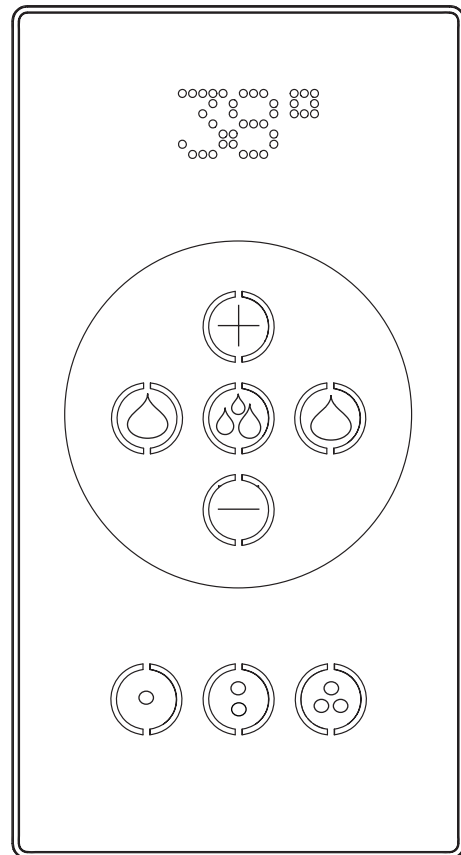

Models Covered:

All WavePlus Showers

**Please keep this booklet for future
reference.**

Installer, when you have read these
instructions please ensure you leave
them with the user.

Contents

Welcome to your new Bristan Digital Electronic Mixer Shower, featuring a contemporary design, wired electronic controller and digital mixing unit. Bristan's Digital Electronic Mixer Shower has been designed to be easy to install and use. It has also been designed and tested in the UK to all of the relevant British Standards.

These instructions are for your guidance to a safe and successful installation, so please read them thoroughly and retain for future reference.

We recommend the installation is carried out by a suitably qualified person and must conform with current I.E.E Wiring Regulations (BS7671) and Building Regulations (Part P and Part G).

Contents

• Important Safety Information	3
• Specifications	4
• Water Requirements	5
• Water Connections	6
• Electrical Requirements	7
• Installation - Mixer Unit	8
• Installation - Wall Outlet	9
• Installation - Interface Unit	9
• Operating the Shower	10-11
• System Set Up	12
• General Cleaning	13
• System - Misc	13
• Maintenance	14
• Alarms	15
• Spare Parts	15
• Guarantee	16

Important Safety Information

- **Please read these instructions thoroughly and retain for future use.**

- All products manufactured and supplied by Bristan are safe provided they are installed, used correctly and receive regular maintenance in accordance with these instructions.

- **If you are in any doubt about your ability to install this product safely you must employ the services of an experienced qualified plumber/ electrically qualified person.**

- This Digital Electronic Mixer Shower needs to be installed in accordance with, and meet the requirements of the Water Supply (Water Fittings) Regulations 1999 and Scottish Byelaws 2004.

Before starting any installation please consider the following:

- Before drilling into walls, check that there are no hidden electrical wires, cables or water supply pipes. This can be checked with the aid of an electronic detector.

- Do not install this shower unit in a room/environment without adequate ventilation or an extractor fitted. This is required to prevent condensation forming within the unit.

- Do not operate the shower unit if the shower head or spray hose has been damaged or is blocked.

- Do not block the flow of water from the shower head, by placing it (smothering it) on your hand or any other part of your body or foreign object.



Warning: Before installing the new Digital Electronic Mixer Shower it is essential that you thoroughly flush through the pipe work in order to remove any remaining swarf, solder, etc. Failure to carry out this procedure could cause problems or damage to the workings of the Mixing Valve.

- Do not operate the shower if the water stops flowing during use or if the water is leaking from the Mixing Valve itself. Turn off at the mains electrical supply and refer to the Troubleshooting section or contact Bristan Customer Services on 0330 026 6273.



Warning: Do not operate this product if you suspect it is frozen. Do not site the Mixing Valve where it might be subjected to freezing conditions.



- Remove all packaging and check the contents for damage before starting any installation.



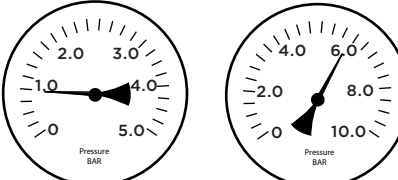
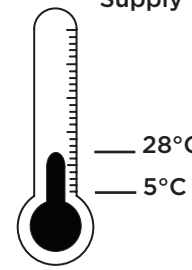
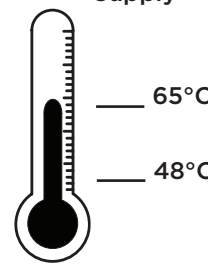

- Fitting isolation valves to the inlet feeds is required as close as is practical to the inlet connections for ease of maintenance.

- Always switch off the power at the consumer unit and isolate the electrical supply before making any electrical connections or if you have to remove the cover of the Control Panel.

- This product must not be modified in any way as this will invalidate the guarantee.

Specifications

Specifications	Inlet Water Temperature	Inlet Connection
<p>Working Pressures</p> <p>Min: 0.1 MPa (1 bar) Max: 0.6 MPa (6.0 bar)</p>  <p>Maximum Static Pressure: 1.0 Pa (10.0 bar)</p>	<p>Cold Water Supply</p>  <p>Hot Water Supply</p> 	<p>1/2" BSP Male Threaded</p>  <hr/> <p>Outlet Connection</p> <p>1/2" BSP Male Threaded</p> 

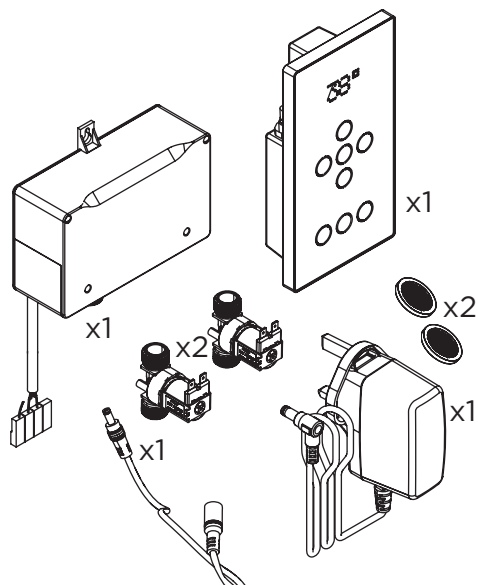
Recommended Usage				Pack Contents	
<p>Domestic</p> 	<p>Heavy Commercial</p> 	<p>Light Commercial</p> 	<p>Healthcare</p> 		

Tools You'll Need

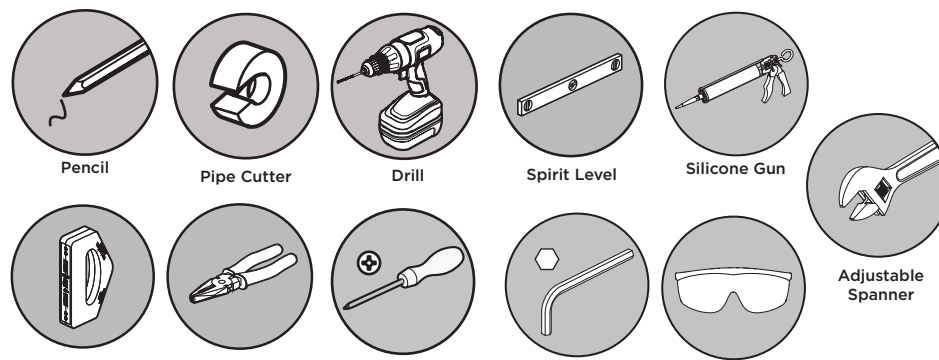

- Pencil
- Pipe Cutter
- Drill
- Spirit Level
- Silicone Gun
- Pipe & Wire Detector
- Pliers
- Cross-head Screwdriver
- 1.2mm Hex Key
- Safety Glasses
- Adjustable Spanner

Measurements

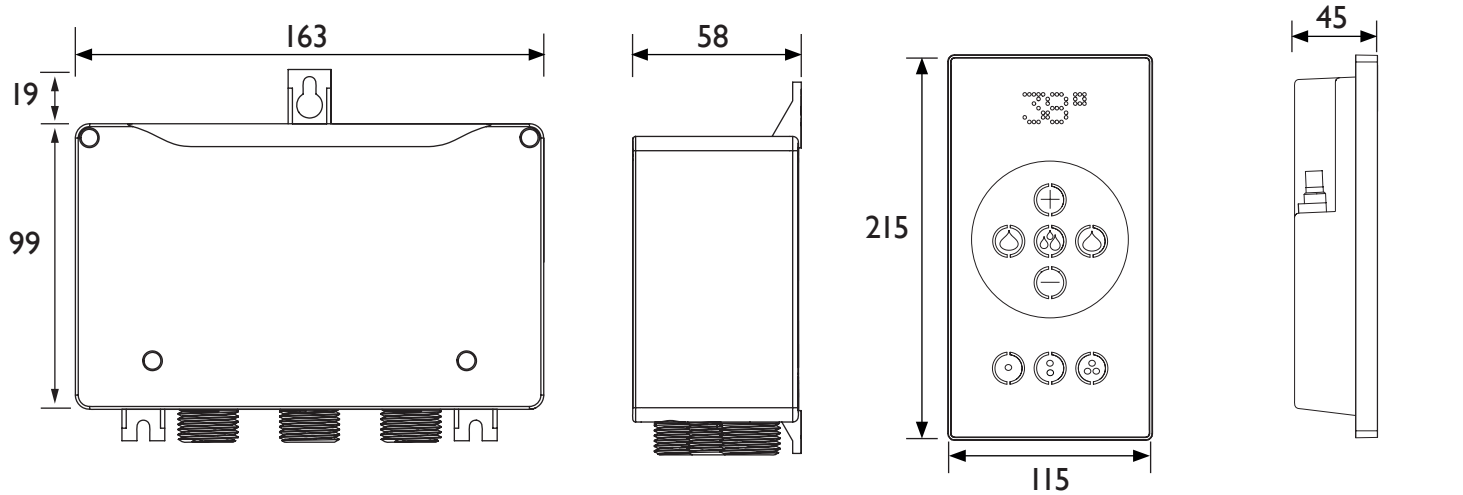

- Top width: 163
- Left height: 99
- Top-left corner: 19
- Depth: 58
- Right height: 215
- Bottom width: 115
- Right depth: 45

Water Requirements

This fitting needs to be installed in accordance with the following Installation Requirements and Notes (IRN) to ensure they meet the requirements of the Water Supply (Water Fittings) Regulations 1999 and the Scottish Byelaws 2014.

The fitting shall be installed so that its outlet discharges above the spill-over level of any fixed appliance as indicated on the illustration to the right.

For backflow protection in premises or installations up to, and including Fluid Category 3 and 5.

The vertical distance of the outlet above the spill-over level shall be not less than 20mm or twice the diameter of the inlet pipe to the fitting, whichever is the greater. If the fitting cannot be installed as indicated it shall be installed with a backflow prevention arrangement suitable for the Fluid Category.

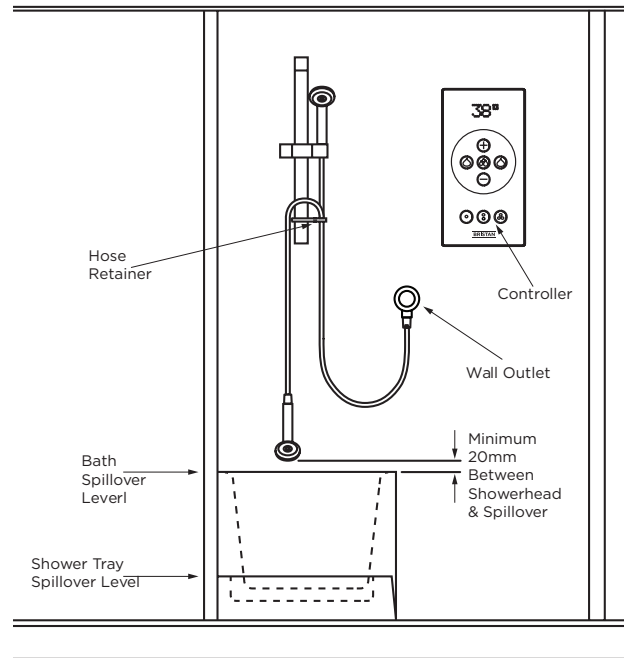

If the shower is to be installed in a hard water area, we recommend that an in-line scale inhibitor is fitted which will prolong the life of the shower. Please refer to your supplier for advice.



Warning: The shower must not be installed in an area subject to freezing conditions. Do not use if you suspect the shower is frozen, this will damage the shower unit.

Maximum ambient temperature: 40°C.

A minimum working inlet pressure of 0.1MPa (1bar) at a minimum flow rate of 10 litres per minute is recommended for full performance.

The maximum static inlet pressure must not exceed 1.0MPa (10bar).

The shower must be connected to a mains water supply only with a minimum working inlet pressure of 0.1 MPa (1bar) at a minimum flow rate of 10 litres per minute. The maximum static inlet pressure must not exceed 1.0MPa (10bar).

If it is intended to operate the shower at pressures above the maximum stated, a suitable pressure reducing valve (PRV) should be used.

Water regulations stipulate that the shower head be 'constrained by a fixed or sliding attachment (hose retainer) so that it can only discharge water at a point not less than 20mm above the spill over level of the bath or shower tray or other fixed appliance.

If a shower head can sit within a bath, basin or shower tray, you must fit a double check valve in the supply pipe work to prevent back siphonage. If the shower head can sit within a WC then the air gap should be a type AUK3 not less than 20mm or twice the diameter of the inlet pipe to the fitting, whichever is the greater.

As this shower unit is already supplied with a single check valve pre-fitted in each water supply inlet, a further single check valve would be required in such a situation, fitted in each water supply as close as possible to the existing check valves.

Water Connections

Plumbing Connections



Warning: Do not solder within 300mm of the Mixing Valve or allow solder or flux to fall onto the casing.



Important: An additional independent stop valve complying with the current water regulations must be fitted in the mains water supply as a means of isolating the supplies to the Mixing Valve for servicing and/or maintenance work.

It is essential that all pipe work is flushed through to remove debris and swarf that could otherwise damage the unit. Once the pipe work has been flushed through, turn off the water supplies at the stop/service valves.

The supplied filter washers supplied **must** be fitted into both inlets.

The connecting pipe work must present 1/2 BSP connectors to the male thread on the inlet connections.



Important: The pipe work must run as straight as possible to the Mixing Valve minimising 90° angled bends as this could affect the inlet pressure to the Mixing Valve reducing performance.

Pumped Inputs

It is possible to use a pump to boost a low pressure system to meet the inlet requirements.

Note: The pump must be a Bristan Twin-End Negative Head Pump - ST NHPUMP 18TN.

Pump installation must be in accordance with the Fitting Instructions supplied with the pump.

The Negative Head Pump is required to maintain the 0.5 bar minimum static pressure requirement.

Electrical Requirements

Power Rating: 240V AC / 12V DC

The Electrical Installation and Circuit Protection of this shower must comply with current I.E.E Wiring Regulations (BS 7671) and Building Regulations (Part P).

All products manufactured and supplied by Bristan are safe provided they are installed, used correctly and receive regular maintenance in accordance with these instructions.

This product must not be modified in any way as this will invalidate the guarantee.

Ensure an electric socket is near the place of installation and can be reached by the power cord. If a socket needs to be installed, please seek the services of a qualified electrician.



Warning: Only the power adaptor supplied with this product must be used

If you are in any doubt about your ability to install this product safely please seek the services of a qualified plumber.

Installation - Mixer Unit

Mounting

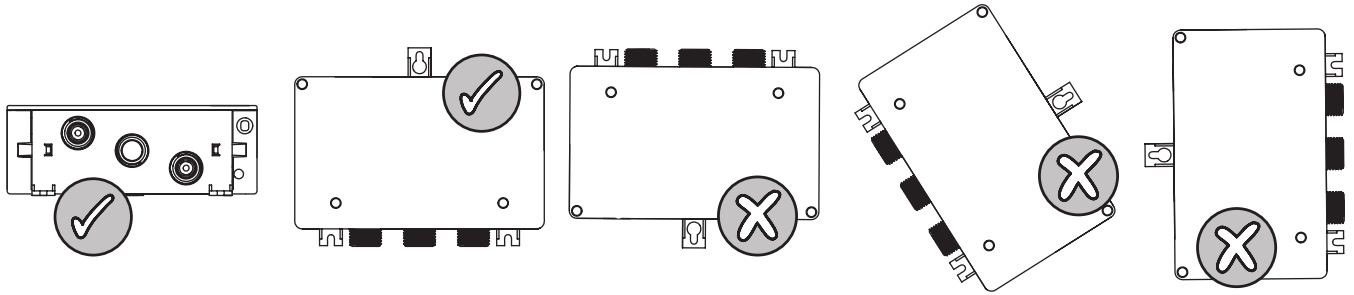

1

REMEMBER
Mixer unit must be installed flat on floor or on a wall with outlets facing down

Find a suitable place for the mixer unit. It must be no further than 1.2m away from a socket & no further than 3m from where the interface unit will be installed. Mark hole & drill, fix the mixer unit to surface using suitable screws (not supplied).

IMPORTANT
Rear access will be required for future service and maintenance.

2

Insert the filters & connect the water supplies.

Hot
Out
Cold

REMEMBER
To flush the pipe work before connecting

IMPORTANT
Fit isolation valves for future service and maintenance.

3

Connect outlet feed.

4

Connect the outlet feed to a T-piece (not supplied) & run the pipe work to elbows.

Connect solenoid valves.

REMEMBER
To chase the cables down the wall to interface unit

5

IMPORTANT
Make sure to fit the spade connectors in the correct pairings.

Slide spade connectors onto each solenoid. The connectors come in the following pairings:

Grey & Blue

Purple & Brown

6

Plug power supply cable into power socket & mixer unit. Plug in the interface unit cable.

Installation - Wall Outlet

Choose the location for the wall outlet and create a 25-30mm hole in the wall. Ensure your shower accessories have enough reach from that position.

Screw the wall outlet into the 1/2" female connection, using a suitable thread sealant ensuring the rubber seal is fitted to the back of the wall outlet.

Fitting a 1/2" female connection at the hole in the wall (not supplied).

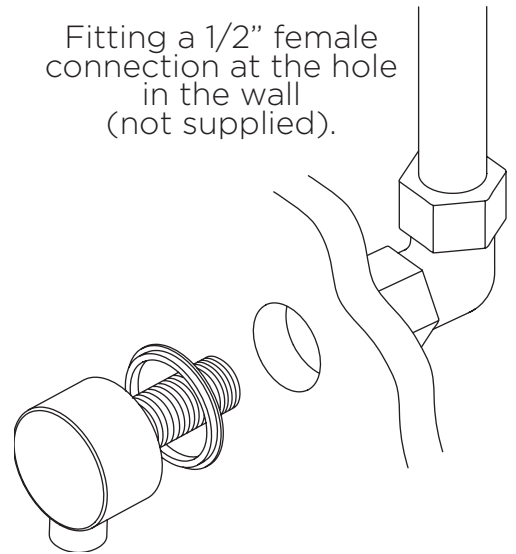

Installation - Interface Unit

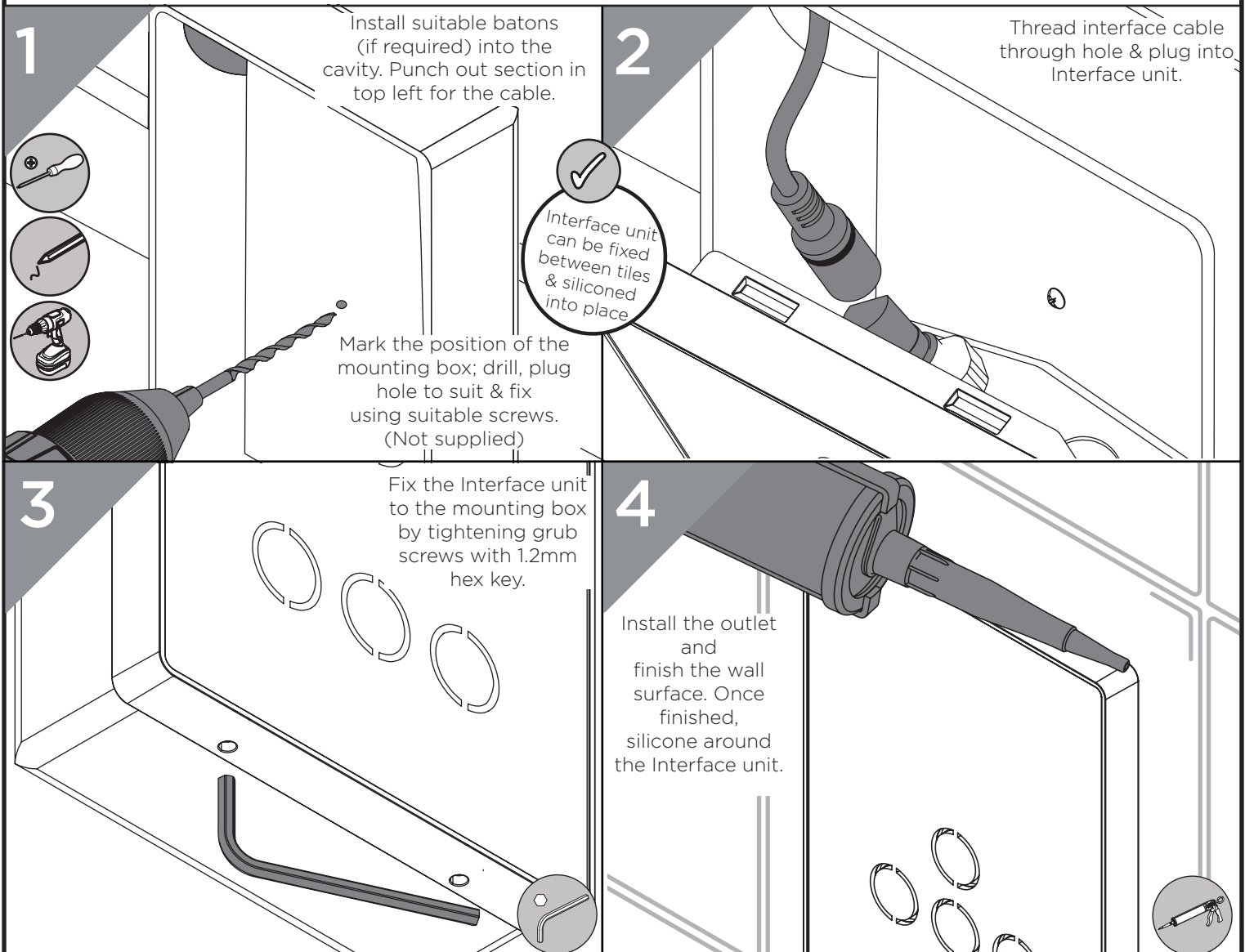

Operating the Shower

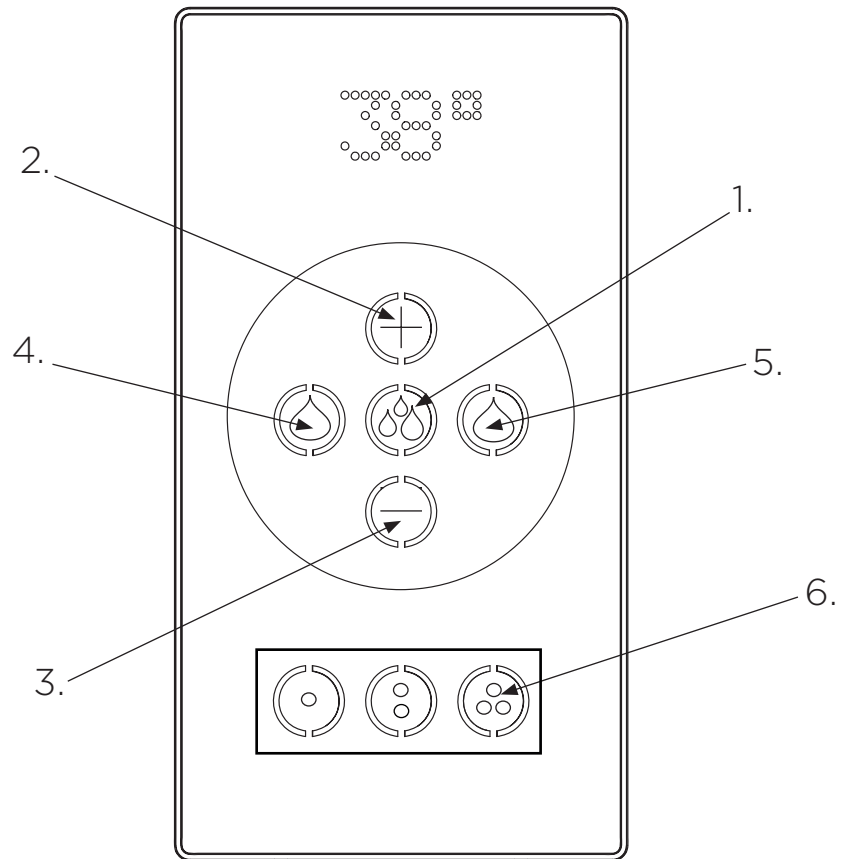
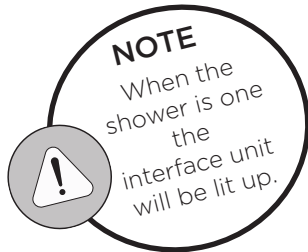



On Mode

1. **Pause/Memory Setting** -

Press once to pause for 5 minutes, for memory setting press and hold.

2.  **Increase Flow Rate** - To increase the flow rate by 1lpm press once, to continuously increase the flow rate press and hold.

3.  **Decrease Flow Rate** - To decrease the flow rate by 1lpm press once, to continuously decrease the flow rate press and hold.

4.  **Increase Temperature** - To increase the temperature by 1°C press the red droplet once, to continuously increase the temperature press and hold.

5.  **Decrease Temperature** - To decrease the temperature by 1°C press the blue droplet once, for a cold water shower press and hold.

6. **Change Outlet** - Press on the desired button to change outlet option.

When using the interface ensure you press in the centre and using the tip of finger.



Operating the Shower

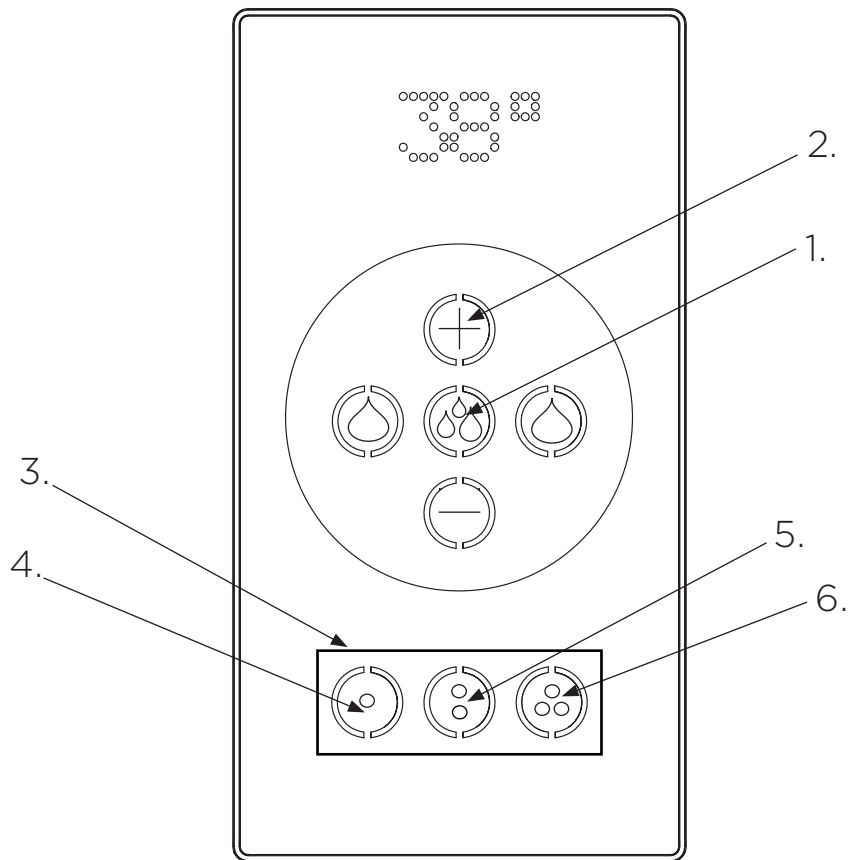

Standby Mode (User Setting Memory/Cleaning)

1. **Start/Warm Up Mode/Main User** - Press once, for start up with current supply temperatures. Press and hold to allow the shower to warm up to preset Master temperature. Press the button again for the shower to start.
2. **Factory Reset** - Press and hold to return memory functions to factory settings.
3. **User Presets** - Select which user preset you wish to use, then press the button to start the shower with this preset.
4. **System Setup** - Press and hold to connect outlets to control panel.
5. **Cleaning** - Press and hold for cleaning process.
6. **Thermal Disinfection** - Press and hold for thermal disinfection process.



When using the interface ensure you press in the centre and using the tip of finger.



System Set Up

1

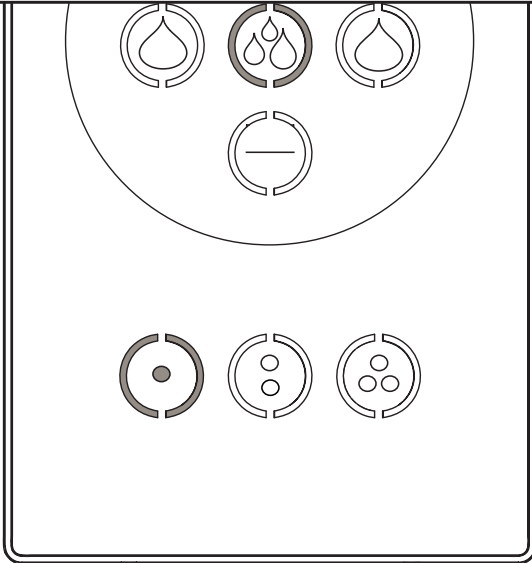

Ensure the shower is in standby mode & hold the O1 button for 6 seconds.

A 5 second countdown will appear before the process starts.

2

During the process, the Start button will flash as different outlets are enabled.

Once finished, the Start button will stay lit. Press the Start button to turn the shower on and check the touchscreen has the correct number of outlets enabled.

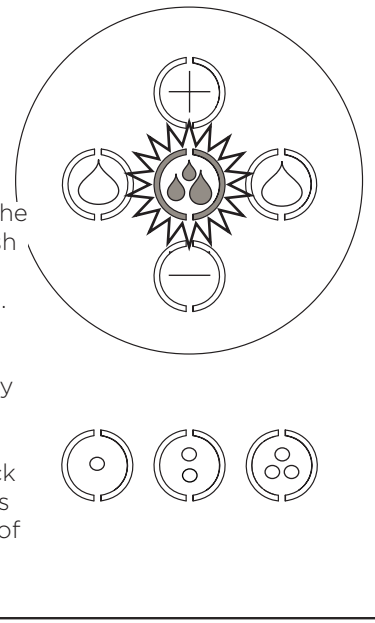

User Customisation - Master

1

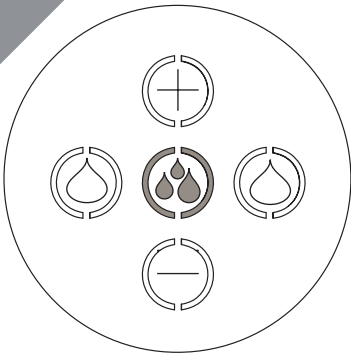

Without selecting a user preset, switch the shower on.

2

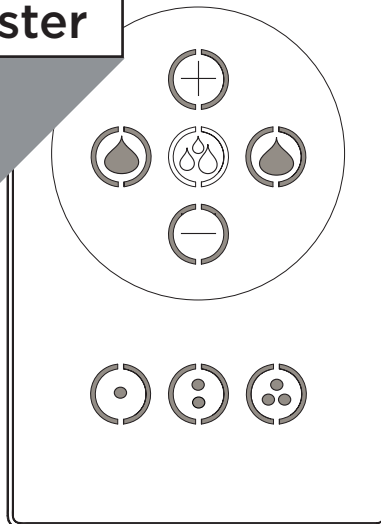

Select the desired flow, temperature & outlet.

3

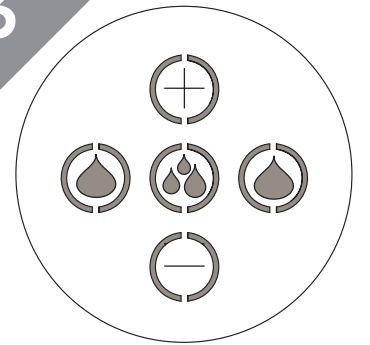

Press & hold the Start button until the control keys light up to save settings.

User Customisation - Optional

1

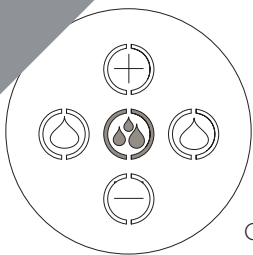

On Standby mode, select which user preset you wish to customise, then switch the shower on.

2

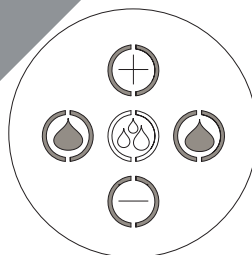

Select the desired flow, temperature & outlet.

3

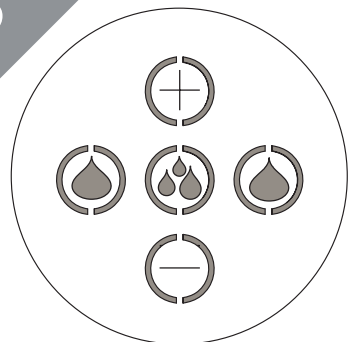

Press & hold the Start button until the control keys light up to save settings.

System - Misc

Reset

1

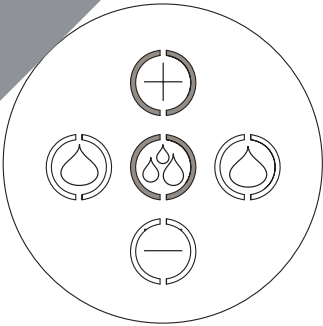

Whilst on Standby mode, press and hold the top button to factory reset.

2

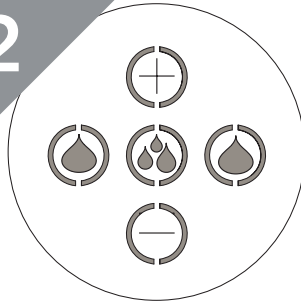

The control keys will light up to confirm that the control panel has been factory reset.

Factory Presets

User	Temperature	Flow Rate
Master	38°C	12lpm
1	Cold Water	12lpm
2	36°C	12lpm
3	40°C	12lpm

Security Lock

1

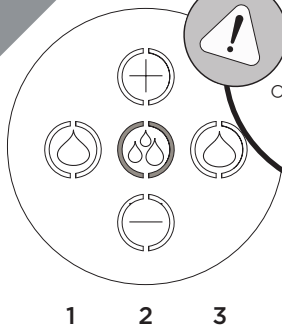

On Standby mode, press the user preset buttons in the following order to lock the Touchpad.

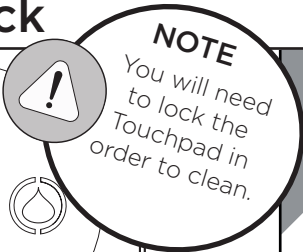

2

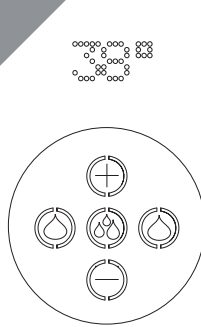

The light around the Start/Main User button will disappear to confirm the Touchpad is locked.

3

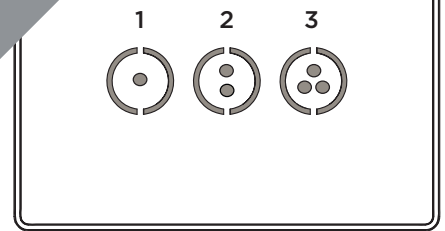

Press the user preset buttons in the same order to unlock the Touchpad.

General Cleaning

Do not use abrasive cleaners or solvents to clean this unit. The interface unit should be cleaned with a soft, clean, damp cloth.

Filters

1

Isolate the water supplies & unscrew connections. Remove both filters.

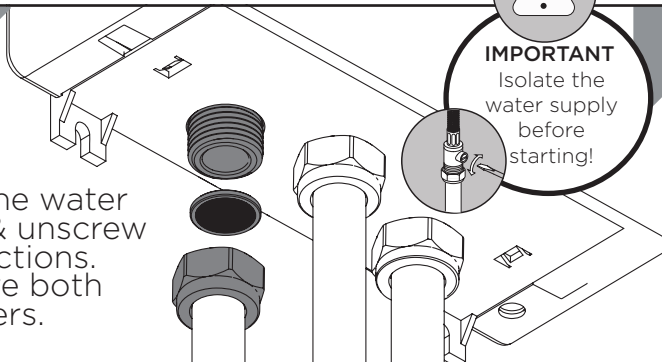

2

Clean filters under cold running water & reverse step 1.

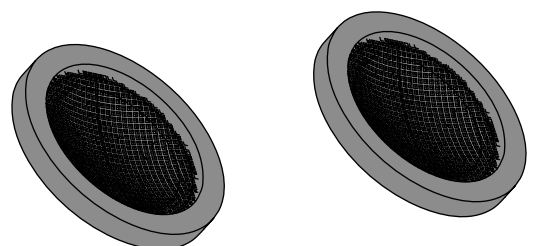

Maintenance

Monthly Cleaning Program

1

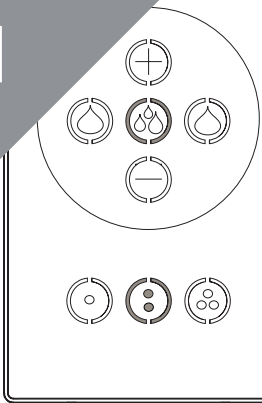

Whilst on Standby mode, press and hold the middle user button to begin the cleaning function.

A 5 second countdown will appear before the process starts.

2

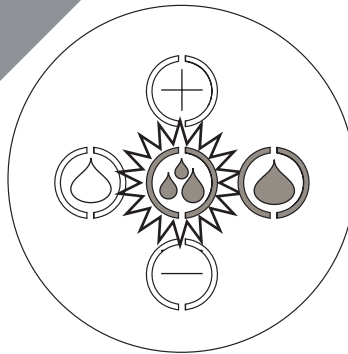

During the process, the Start button will flash whilst the cold button is illuminated.

Once finished, the Start button will stay lit.

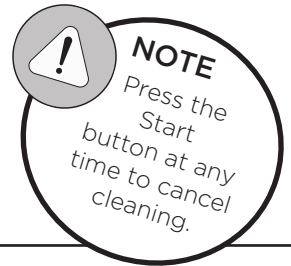

NOTE

Press the Start button at any time to cancel cleaning.

Thermal Disinfection

1

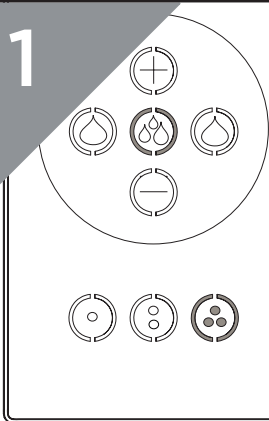

Whilst on Standby mode, press and hold the right user button to begin the thermal disinfection function.

A 9 second countdown will appear before the process starts.

2

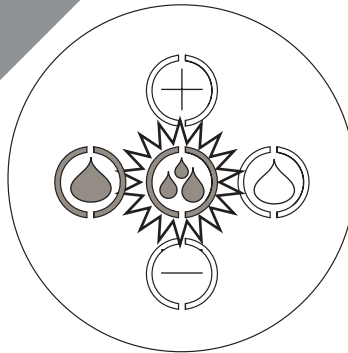

During the process, the Start button will flash whilst the hot button is illuminated.

Once finished, the Start button will stay lit.

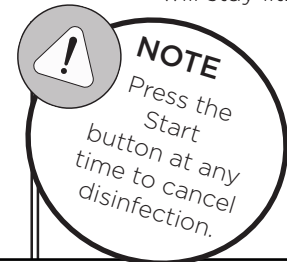

NOTE

Press the Start button at any time to cancel disinfection.

Alarms

Error Message	Cause	Recommended Action
AL1 displayed	Cold water leakage.	Run the Monthly Cleaning and Thermal Disinfection Programs. If problem persists, replace device.
AL2 displayed	Hot water leakage.	
AL3 displayed	Cold water supply failure.	Check pipe work for any blockages and that water is reaching the inlets. Clean filters and replace if necessary. Check that the solenoid spade connectors are paired in the correct colours: Grey & Blue; Purple & Brown . If problem persists, please contact Customer Services.
AL4 displayed	Hot water supply failure.	
AL5 displayed	Insufficient hot water temperature.	Hot water needs to be at least 10°C higher than the user set temperature. Check your hot water is functioning correctly.
AL6 displayed	Cold water temperature too high.	Refer to the specification for Cold Water requirements. Check your cold water is functioning correctly.
AL7 displayed	Temperature sensor malfunction.	Contact Customer Services to replace the product.
AL8 displayed	Low set point for saturation	Check your hot water is functioning correctly and heating to the correct temperature. If correct, check if the problem occurs on another outlet. If the other outlet works, check that there are no devices e.g. flow regulators impeding flow to the problem outlet.
AL9 displayed	Thermal Disinfection interruption	Check pipe work for any blockages and that water is reaching the inlets. Clean filters and replace if necessary. If problem persists, please contact Customer Services.
AL10 displayed	Warm Up Error - the flow rate/set temperature couldn't be reached	Check your hot water is functioning correctly and heating to the correct temperature. If correct, repeat the process.
AL11 displayed	Bath Fill error - the set temperature has not been reached.	
AL12 displayed	Hot water transducer failure	Try re-starting the device. Check that the solenoid spade connectors are paired in the correct colours: Grey & Blue; Purple & Brown . If the problem persists, replace the device.
AL13 displayed	Cold water transducer failure	
AL14 displayed	Freezing risk	The system has detected that the cold water temperature is lower than 5°C. Increase the cold water supply temperature.
ER1 displayed	Communication error.	Check condition of cables and connectors. If problem persists, it may be due to interference in the network. Try connecting to another power point.

Spare Parts

To replace any spare parts for your shower why not scan the QR code and search for your product.



Issue: B

Part Number: WVP DVO BC

Guarantee

At Bristan, we want to make things as easy as possible for our customers. That's why we offer solid guarantees on all our products, effective from the date of purchase, to give you peace of mind.

To start your free guarantee simply scan the QR code and register your product. Alternatively visit www.bristan.com/register.



For any other queries, please call our Customer Service on 0330 026 6273 where our expert team of advisors will be able to offer you any help and advice.

For full guarantee terms and conditions visit www.bristan.com/guarantees.

BRISTAN

Bristan Group Ltd.

Birch Coppice Business Park
Dordon
Tamworth
Staffordshire
B78 1SG

Web: www.bristan.com

Email: enquire@bristan.com