

J BAS C

JAVA Tap Range

Java Basin Mixer with
Clicker Waste Chrome



Features:

- Long life ceramic cartridge for added durability and ease of use
- Metal fixing nut for added durability
- Flexible tails included
- Includes clicker waste

Product Certifications:



WRAS Cert. Number: 1610001
WRAS Expiry Date: 31/10/2021



For more products, visit our website:
<http://www.bristan.com>



Specification

Product Type:	Bathroom Tap
Main Construction Material:	Brass
Mount Type:	Deck Mounted
Handle Type:	Lever Handle
Connection Inlet:	1/2" BSP Flexible Tails
Connection Outlet:	M24 5lpm Flow Limiter
Number of Tap Holes:	1
Valve/Cartridge Type:	40mm Ceramic Cartridge
Plumbing System Requirements:	Suitable for all plumbing systems
Minimum Dynamic Pressure (bar):	0.2 bar
Maximum Dynamic Pressure (bar):	5.0 bar
Maximum Hot Water Temperature °C:	65°C
Maximum Static Pressure (bar):	10 bar
Flow Type:	Single Flow
Isolation Included:	No

Dimensions (measurements in mm)

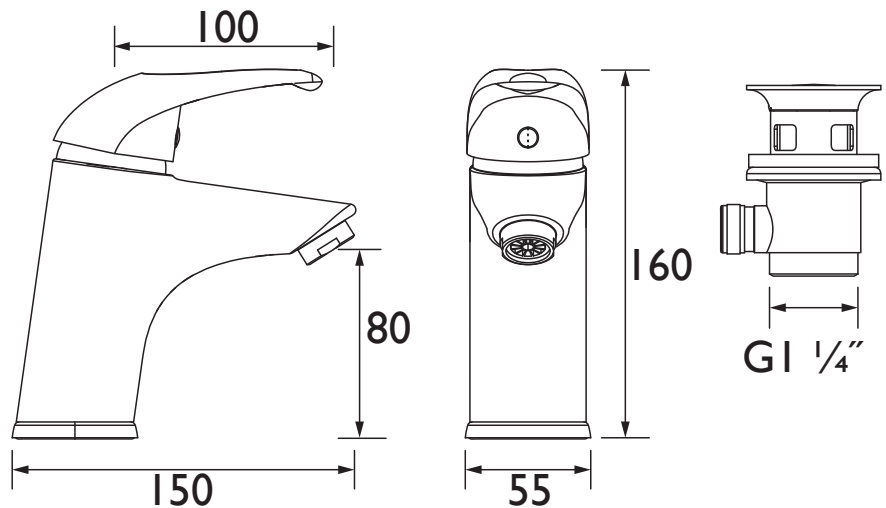

Flow Rates (l/min)

System Pressure (bar)	0.2	0.5	1	2	3	5
J BAS C (mixed)	5	5	5	5	5	5

TECHNICAL
DATA
SHEET



BRISTAN

D15