

BRISTAN

TAPS & SHOWERS

Installation Instructions & User Guide

Please leave these instructions with the end user

Product Code: MPL EFSNK C (D1)

Specifications

Inlet Water Temperature

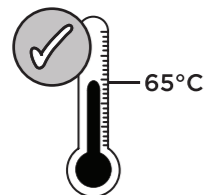

Maximum Hot 65°C

Dynamic Water Pressure

Min: 0.3 bar

Max: 5.0 bar

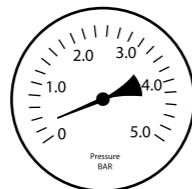

Maximum Static Pressure: 10.0 bar

Inlet Connections

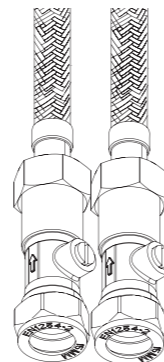

1/2" BSP Flexible Tails with Isolation Valves

Non-Return Valves Included

Tools You'll Need

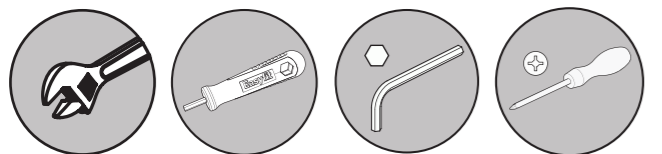

Adjustable Spanner EasyFit Tool Hexagonal Key Crosshead Screwdriver

Spare Parts

To replace any spare parts for your tap, why not scan the QR Code or visit www.bristan.com and search for your product.



Prior to Installation

All products manufactured and supplied by Bristan are safe provided they are installed, used correctly and receive regular maintenance in accordance with these instructions.

This product has been tested to the Water Regulations Advisory Scheme (WRAS) and satisfies the requirements of the Water Supply (Water Fittings) Regulations 1999 and current bylaws. For full Installation Requirements & Notes (IRN) please visit wras.co.uk/directory.

Isolation valves must be fitted to the inlet water supplies to ensure ease of future maintenance.

Before installing these taps the water supply must be thoroughly flushed in order to remove any swarf, solder etc.

This product must not be modified in any way as this will invalidate the guarantee.

Flexible Connecting Pipes

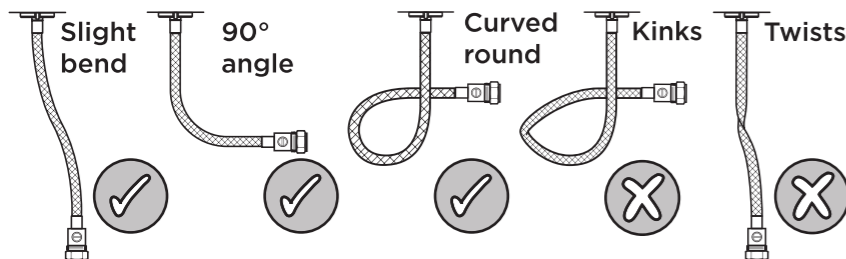

Pack Contents

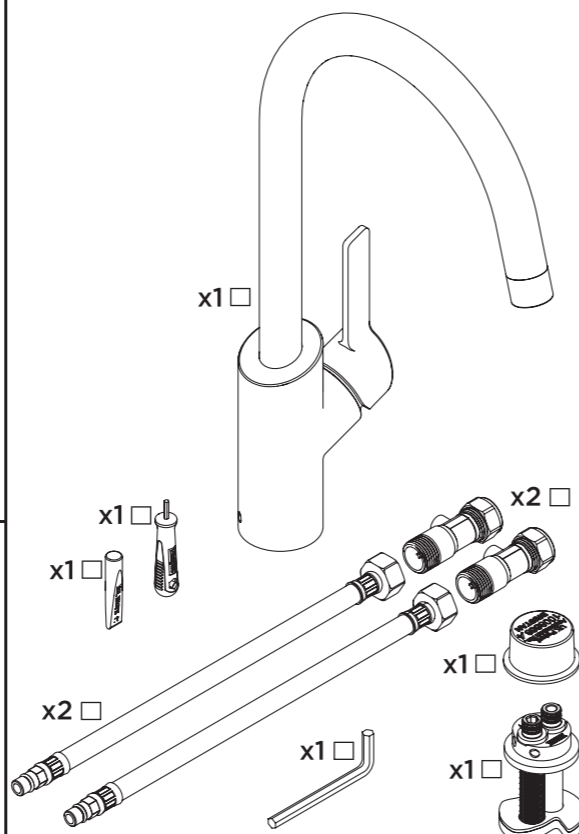

Installation

1 Remove the protective cap from the base assembly.

Feed the base through the sink hole from the top.

8mm

If the surface the tap is being fitted to is over 8mm; or you feel the tap needs extra stability, follow the **alternative installation steps** overleaf.

2 Drop the Plain Inlet Connector into the base.

REMEMBER Make sure the base is centralised when viewed from the front of the tap.

Ensure flat area of the plain inlet connector sitting flush adjacent to threaded inlet connector.

3 Turn the hexagonal key clockwise until the base is secured.

6.0 mm

4 Screw the flexible tails into the base.

DO NOT OVER-TIGHTEN

5 Connect the hot and cold water connections.

REMEMBER hot on the left, cold on the right.

Olive Compression Nut

6 Grease the O-Rings using the Molykote Grease provided.

7 Place your desired tap onto the base.

IMPORTANT Ensure the tap is correctly positioned and fully located on the base.

8 Remove screw covers and set aside.

Secure in place with the grub screws using the tool provided.

9 Thread the hexagonal key through the EasyFit tool and tighten the grub screws with an extra 1/2 turn.

Once tightened, replace the screw covers

Your tap is now ready to use.

General Cleaning

Bristan products are made from premium materials, with hand polishing and electroplated finishes.

Your taps or shower should be regularly cleaned with warm water, a mild pH-neutral liquid soap, and polished with a soft cloth. Any residues from soap, toiletries etc. should be rinsed off straight after use.

Household bleaches and cleaners contain harsh chemicals and may damage the surface finish. Avoid using abrasive cloths, scouring pads, scrub sponges, steel wool or anything similar.

Some surfaces such as nickel and pewter may be affected by the dye found in some cloths, so it is also important to avoid hanging cloths on spouts.

Operation - Eco-Start

The temperature will gradually rise the further the rotation of the handle.

Once the handle ceases to turn, it will be **supplying the maximum temperature.**

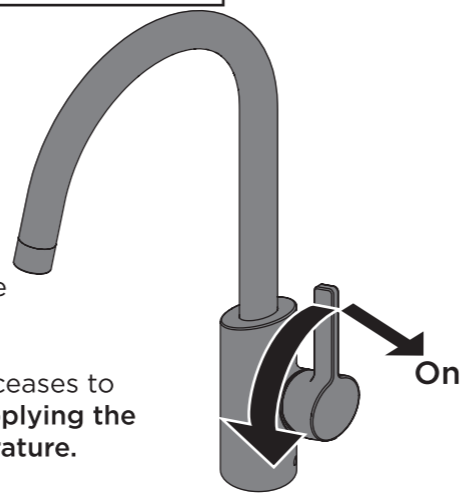

Increase temperature

Maintenance - Cartridge Removal/ Replacement

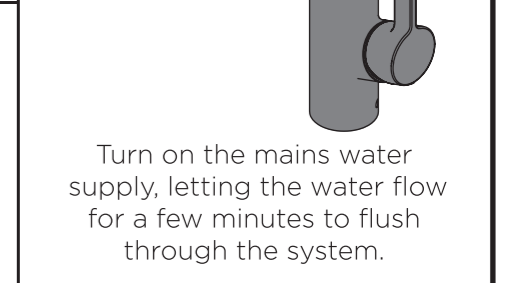
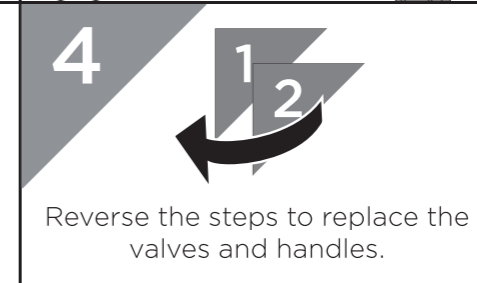
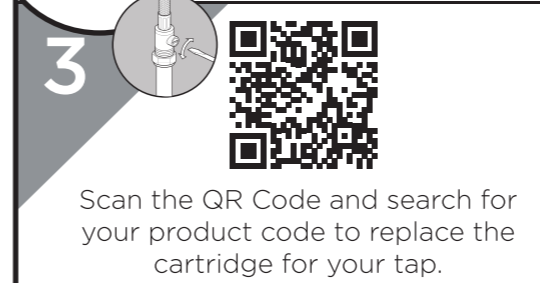
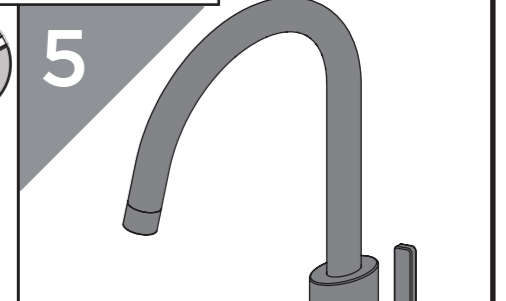
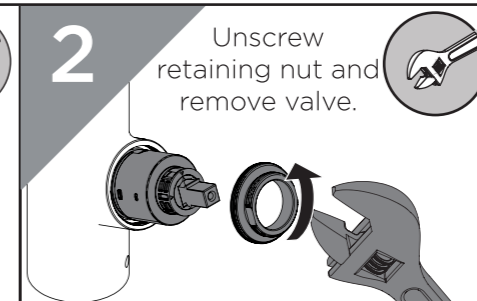
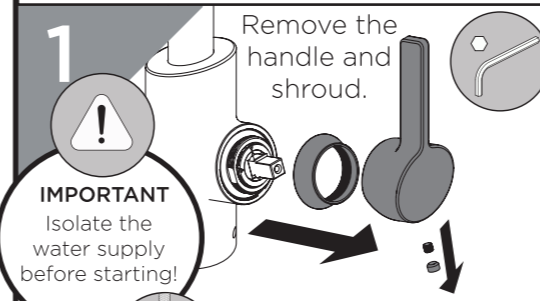

Alternative Installation for Surfaces Out of Tolerance/Extra Stability

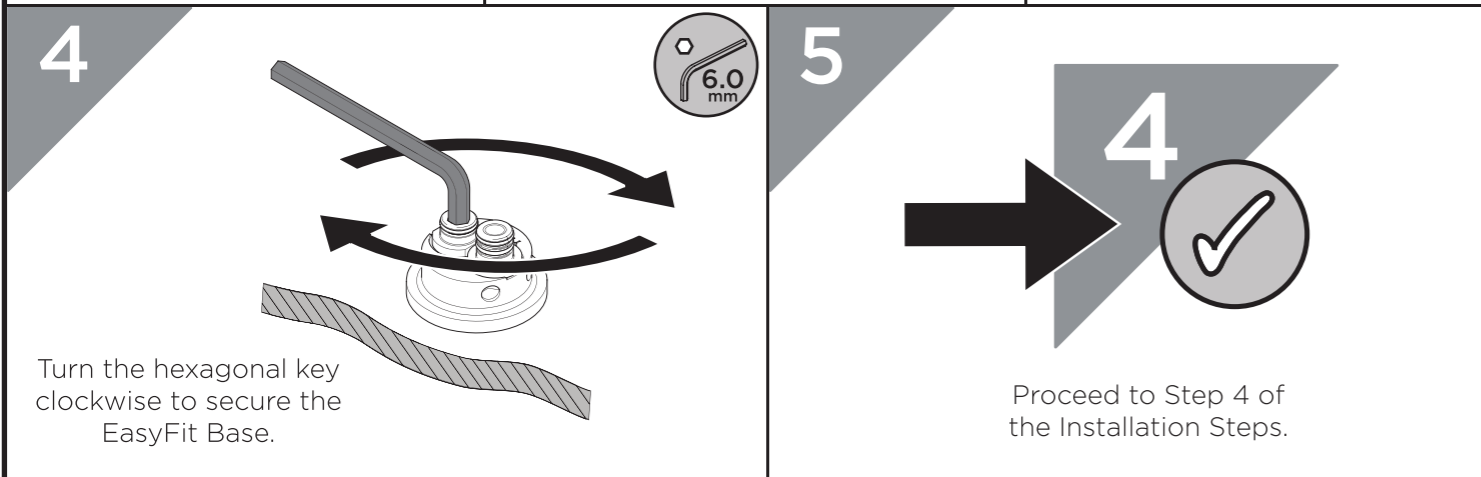
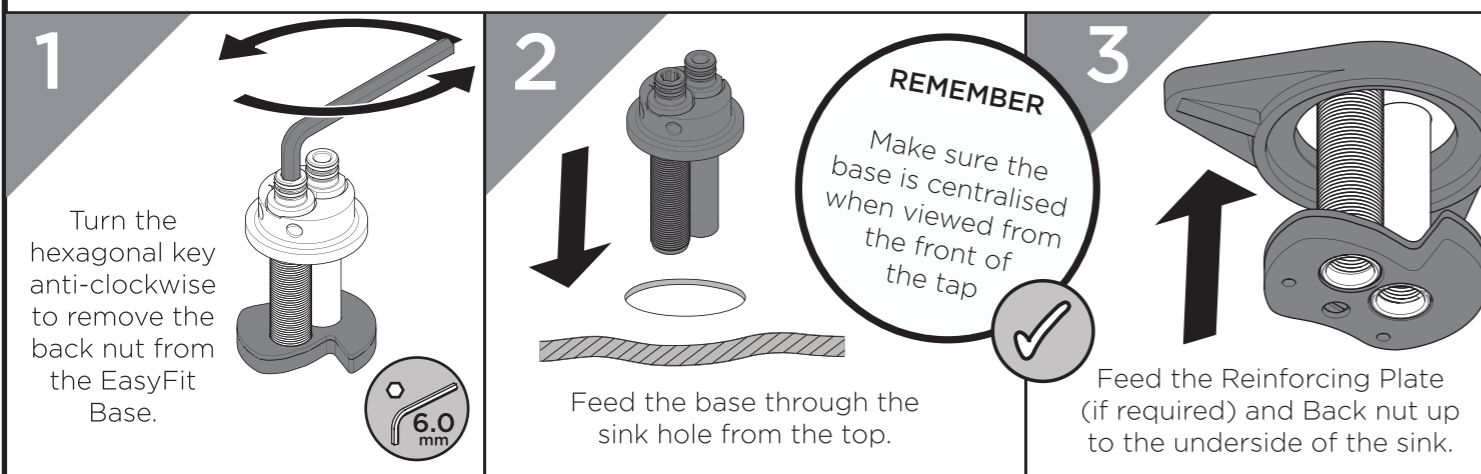

Troubleshooting

Symptom	Cause(s)	Remedy
No flow or low flow rate	Partially closed isolation valve.	Open isolation valve.
	Head of water is below the minimum distance required.	Refer to your specification for the minimum working pressure/ distance required
	Hot or cold water being drawn off elsewhere causing pressure changes or instantaneous boiler temperature changes.	Do not use other water outlets when using the taps.
	Airlock or partial blockage in the supply pipework or hoses.	Flush through pipework to ensure removal of debris and any airlocks.
	Water supply failure	Investigate water supply. Check your plumbing and heating systems for any faults.
Water dripping from taps	This is normal for a short time after using the taps.	This is caused by residual water tension, the build up of water in the tap body.
	If water continues to drip, possibly due to the ceramic disc valves/cartridge	Refer to the Maintenance section to replace the valves/ cartridge.
Taps do not turn on	Closed isolation valve.	Open isolation valve.
	Mains water supply turned off.	Turn on mains water supply.
Wobbly Tap	Grub screws are not tight enough at the base	Ensure the grub screws are fully tightened against the base
	Extra security may be required depending on the surface the tap is fitted on to.	Refer to the Alternative Installation steps in order to fit the Reinforcing Plate.

Maintenance - Cleaning/Replacing Outlet

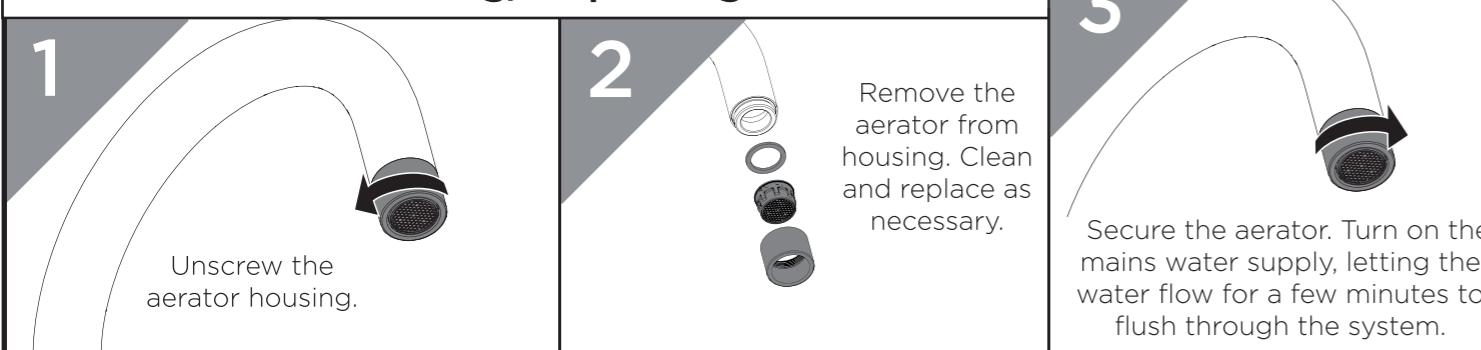

At Bristan, we want to make things as easy as possible for our customers. That's why we offer solid guarantees on all our products, effective from the date of purchase, to give you peace of mind.

To start your free guarantee simply scan the QR code and register your product. Alternatively visit www.bristan.com/register.

For any other queries, please call our Customer Service on 0330 026 6273 where our expert team of advisors will be able to offer you any help and advice.

For full guarantee terms and conditions visit www.bristan.com/guarantees.

